

FORT WORTH STOCKYARDS

FORM-BASED CODE & DESIGN GUIDELINES



ADOPTED

May 02, 2017



PREPARED FOR:

City of Fort Worth

MAYOR AND CITY COUNCIL:

Betsy Price, Mayor

Sal Espino, District 2

W.B. Zimmerman, District 3

Cary Moon, District 4

Gyna Bivens, District 5

Jungus Jordan, District 6

Dennis Shingleton, District 7

Kelly Allen Gray, District 8

Ann Zadeh, District 9

HISTORICAL AND CULTURAL LANDMARKS
COMMISSION:

Edith Jones

Brenda Sanders Wise

Mitchell Moses

Randle Howard

Gannon Gries

Paul Randall

Robert Gutierrez

Billy Daniels, Jr.

CONSULTANT TEAM:

Code Studio, Project Lead

Winter & Company, Historic Preservation

Third Coast Design Studio, Urban Design

Noell Consulting Group, Market Analysis

Toole Design Group, Mobility

Berkenbile Landscape Architects, Landscape

STAFF RESOURCE TEAM:

Fernando Costa, Assistant City Manager

Randle Harwood, Planning Director

Dana Burghdoff, Assistant Director-Planning

Randy Hutcheson, Planning Manager

Laura Voltmann, Senior Planner

Sevanne Steiner, Senior Planner

Murray Miller, Historic Preservation Officer

ILLUSTRATIONS:

Sketches by Murray Miller

Historic photographs courtesy of
Stockyards Museum, City of Fort Worth

ASSISTANCE FROM:

North Fort Worth Historical Society

HISTORIC OVERVIEW ADAPTED FROM:

Fort Worth Stockyards Historic District National
Register Nomination (1976)
The Fort Worth Stockyards national historic
district: An illustrated history and guide
by Horace Craig

CONTENTS

| | |
|------------------------------------|------|
| Introduction | 0-1 |
| How to Use this Document | 0-23 |
| Article 1. Opening Provisions | 1-1 |
| Article 2. Historic District | 2-1 |
| Article 3. Transition District | 3-1 |
| Article 4. Edge District | 4-1 |
| Article 5. Rules for All Districts | 5-1 |
| Article 6. Land Use Provisions | 6-1 |
| Article 7. Site Standards | 7-1 |
| Article 8. Street Standards | 8-1 |
| Article 9. Administration | 9-1 |
| Article 10. Definitions | 10-1 |

The UDC recommends that in support of ongoing heritage tourism at the Fort Worth Stockyards, the City of Fort Worth should work cooperatively with the Economic Development Department and Events Facilities Department to pursue potential opportunities for permanent parking for vehicles of audiences attending events at the Colesium, and for transport of live-stock, including trucks and trailers, to be located along the storm water easement area, as related to specific requirements for utility easements and existing infrastructure located there.

Also, the UDC recommends that City should explore all potential options to preserve and enhance opportunities for museums and other cultural facilities to maintain their presence at desirable locations within the Stockyards, through coordination with the Economic Development Department and other relevant institutions, and to identify potential incentives and programs that can promote their ongoing economic viability, so that they can continue to operate in a manner that enhances heritage tourism within the Fort Worth Stockyards.

INTRODUCTION

- Background 0-2
- The Stockyard Districts 0-4
 - Historic District 0-4
 - Transition District 0-4
 - Edge District 0-4
- Historic Framework..... 0-6
 - Period of Significance 0-6
 - Historic Development Patterns: 1911 0-8
 - Historic Development Patterns: 1927 0-10
 - Historic Development Patterns: 1951 0-11
 - The Stockyards Today 0-11
- Circulation and Access Patterns 0-13
- Historic Figure-Ground Patterns 0-14
 - Details of Historic Figure-Ground Patterns 0-15
- Character Defining Features..... 0-16
 - Circulation Patterns 0-16
 - Landscape and Site Features 0-17
 - Buildings 0-19
- View Opportunities 0-21



Background

The Fort Worth Stockyards was one of the largest livestock markets in the United States and a defining factor for the community. Beginning in the 1870's with the arrival of the railroad, it served as a major employment center, reaching its peak in 1944, when it processed over 5 million cattle. As the industry changed, the Fort Worth Stockyards transitioned from an important center for the meat packing and livestock industry to a visitor destination, attracting residents from the region as well as tourists from across the nation and abroad. Today, the Stockyards is challenged to set a direction for the future while honoring its working heritage. As the population of Fort Worth and North Texas continues to grow, development pressures are quickly transforming central Fort Worth. The Stockyards area is no exception.

This document (the Stockyards Form-Based Code and Design Guidelines) is intended to promote rehabilitation and compatible new construction that is sensitive to the surrounding historic context. By preserving existing buildings and guiding compatible new development, this document will also help to promote cultural, environmental and economic sustainability.

The Stockyards project area covers almost 300 acres and includes the Historic Stockyards themselves, the Marine Creek area, the Swift and Armour meatpacking sites, the North Forty area, the commercial corridors of Main Street and 28th Street, and portions of the North Side and Diamond Hill - Jarvis neighborhoods. The map (to the right) shows two separate boundaries: the boundary for the entire Stockyards area and the local historic district boundary designated by the City Council.

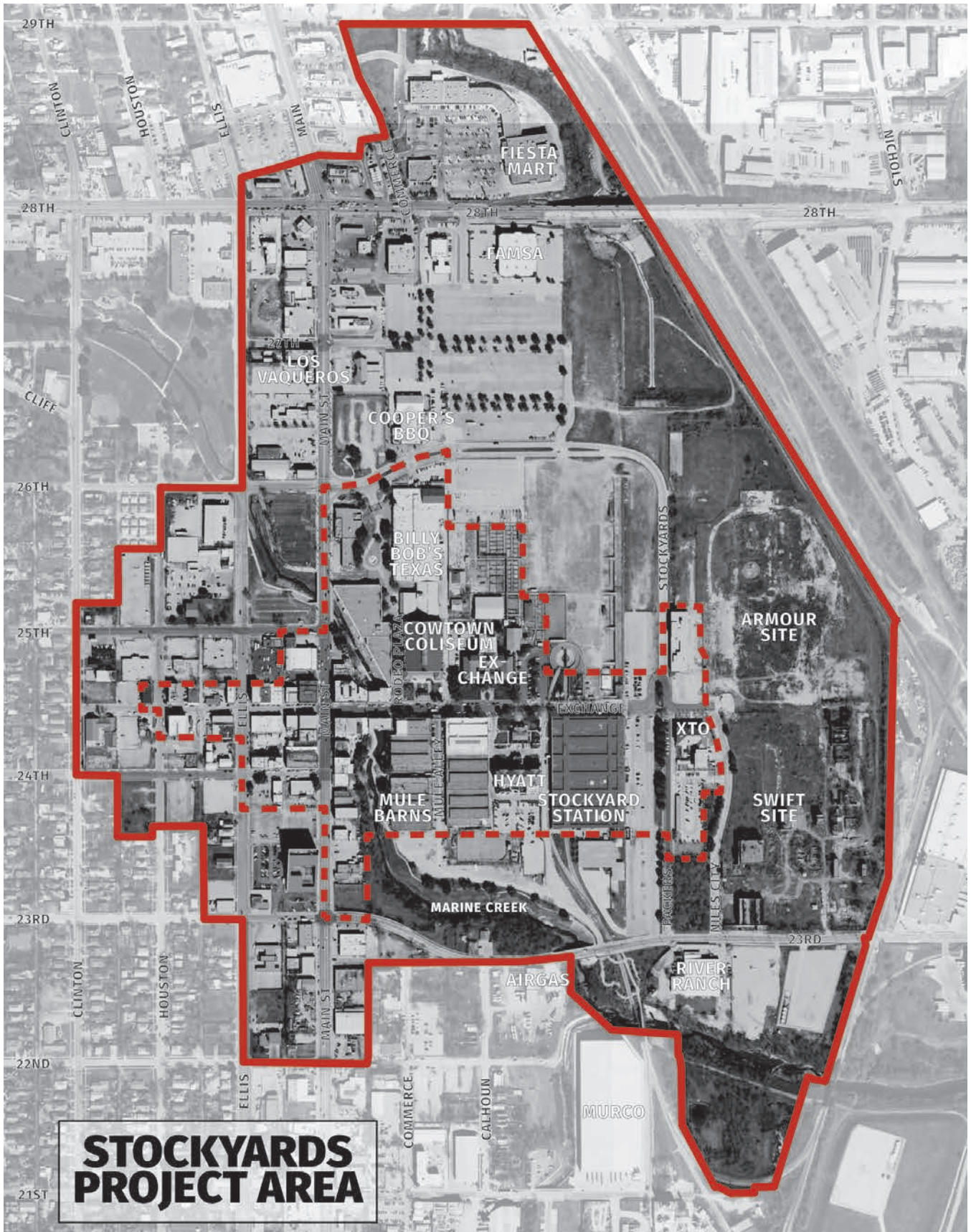

- Project Boundary
- - - Local Historic District

The Stockyard Districts

HISTORIC DISTRICT

The Historic and Cultural District is an extremely important resource for the City of Fort Worth. The core of the area is designated locally as a historic district and a larger area is listed in the National Register of Historic Places. The locally designated historic district is rich with buildings that serve as a link to the region's heritage and the dramatic impact that the Stockyards had on the historic development patterns in the area. While only some of these buildings remain, their influence is still felt.

The Fort Worth Stockyards Historic District was added to the National Register of Historic Places in 1976, and locally-designated as the Fort Worth Stockyards Historic and Cultural Landmarks District in 2016.

Highlighted in red in the map on the following page, the Historic District stretches along Exchange Avenue to encompass the buildings used in the operations of the stockyards. On the west side, the Historic District stretches along Main Street to capture the commercial buildings related to the Stockyards operation. Marine Creek also acts as a natural boundary that runs through the District and separates the Stockyards from the commercial core. The Historic District has a series of implementing sub-districts that come in a variety of height patterns (see also [Div. 2.1](#)):

1. Historic Shopfront; and
2. Historic Core.

TRANSITION DISTRICT

The Transition District is intended to form a buffer around the Historic District. The objective is to promote development that is compatible with the Historic District along its periphery, while permitting a transition to buildings of larger scale farther away from the Historic District. Development also is intended to be influenced by the design traditions

of the larger Stockyards area and the former Swift/Armour properties, in terms of form, materials and character, but in more abstract ways than within the Historic District itself. The Transition District also has a series of implementing sub-districts that come in a variety of height patterns (see also [Div. 3.1](#)):

1. Transition Marine Creek;
2. Transition North Forty;
3. Transition Neighborhood Mixed Use;
4. Transition Northern Edge; and
5. Transition Swift/Armour.

EDGE DISTRICT

The Edge District is the area most removed from the Historic District. As such, greater flexibility in design is available here, in terms of form, character and materials. While this area was historically associated with the Stockyards, little evidence of this remains today and new development is anticipated here that will be less influenced by historic precedents. Therefore, greater variety in building form and materials is appropriate in the Edge District. An objective is to provide services that support the overall Stockyards area and adjacent neighborhoods. The Edge District has its own series of implementing sub-districts that come in a variety of height patterns (see also [Div. 4.1](#)):

1. Edge Neighborhood Mixed Use; and
2. Edge Commercial Corridor.

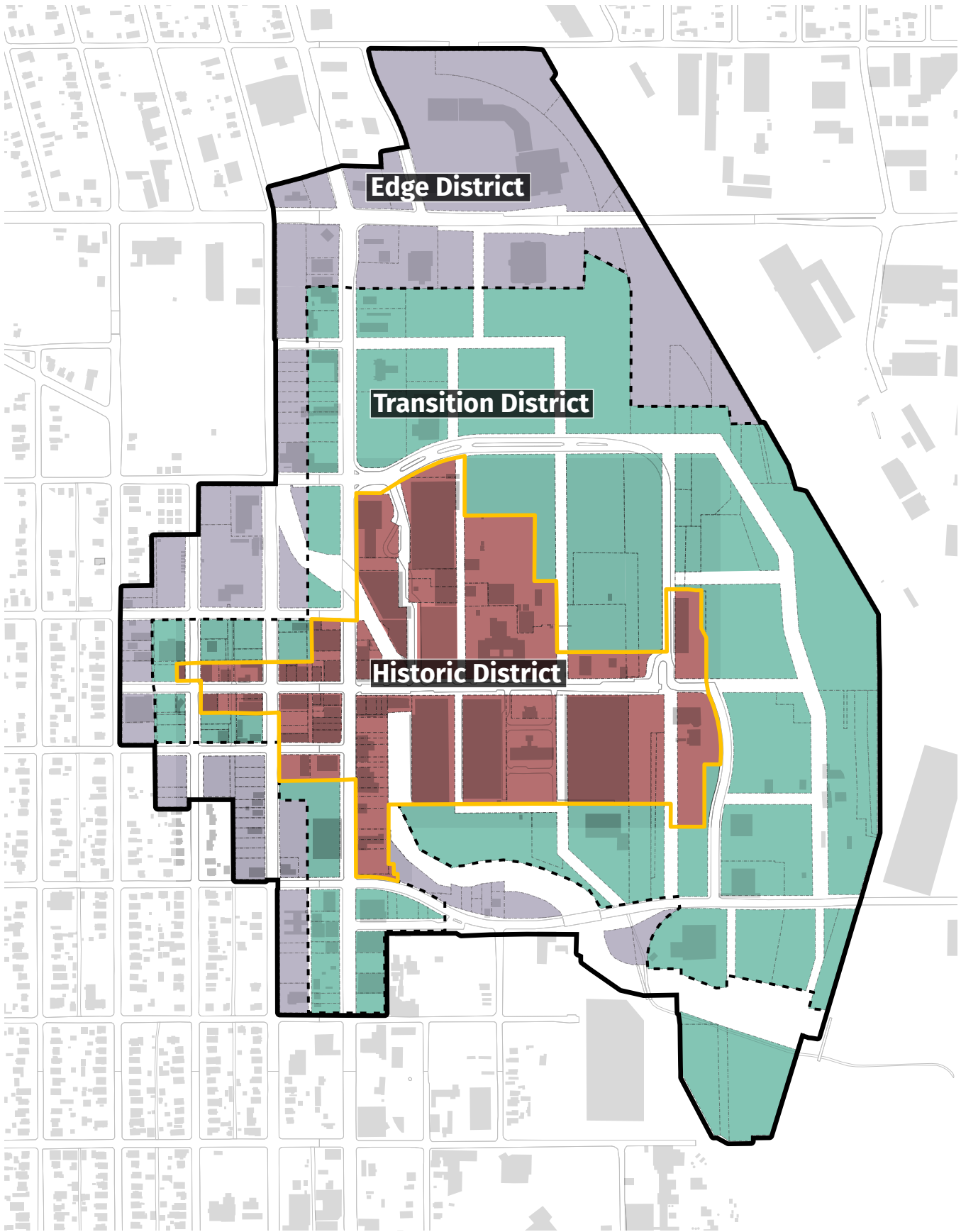

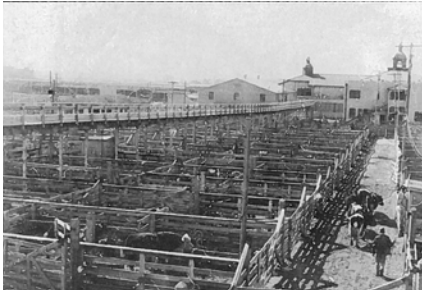

Workers drive cattle from pens behind the Livestock Exchange Building to weigh stations.



The Armour and Company office building, built in 1902. The Swift office building (ca. 1920s) is similar in style.



Events such as the 2008 Chevy Thunder Days now take place where the cattle pens once stood.

Historic Framework

The significance of the Stockyards in the history of Fort Worth is evident by the city’s nickname, “Cowtown,” and the adoption of the longhorn head as an emblem for the City of Fort Worth. From dusty cattle drives in the decades after the Civil War to the industrial processing of beef throughout the first half of the twentieth century, the bovine figured prominently in the evolution of Fort Worth from a frontier village to a modern city. The Fort Worth Stock Yards Company and vast Texas herds assured the city’s predominance as a major national livestock market. As a railroad center, Fort Worth was an excellent choice for the location of national meatpacking plants. The resulting industrialization led to exponential population and economic growth for the city.

The Stockyards district today still retains many of its character-defining features, such as the circulation patterns used to move livestock to the packing plants and a vibrant collection of early 20th-century commercial buildings that were erected to support the meatpacking plants. The high degree of integrity within the local Historic District is significant because it represents a remnant of an extinct industrial American form.

The degree to which the Historic District, as it exists today, conveys its historic character is a key consideration in determining how rigorously the design guidelines should be applied to an individual project. A review of historical data and photographs informs one’s understanding of the way in which the district retains its early character and also the degree to which the district exhibits change during its period of historic significance. This change demonstrates that the district was not “frozen” in time, but shows a history of gradual development, modification and restoration. This evolution is a key characteristic. At the same time, any future changes must take the historic context into account and preserve the key character-defining features that contribute to the significance of the district. This is essential when determining appropriateness of future alterations to historic properties and for designing compatible new construction. These key character-defining features are also important in understanding the “period of significance” for a district.

PERIOD OF SIGNIFICANCE

The key period during which the Stockyards took on historic significance is between 1902 and 1962. Features (including landscapes, buildings, pens, streets, walkways, paving, stairs and retaining walls) that date from this period contribute to the significance of the Historic District and aid in its interpretation. While development and prosperity in the cattle industry began in the area prior to 1902, namely the construction

of livestock pens and of nearby railroad tracks, the Swift and Armour companies began construction of their meat packing facilities in 1902, with business beginning in 1903. The further construction of expanded rail lines, the Coliseum and the Exchange buildings established the Fort Worth Stockyards as the major livestock market of the southwest and a key economic generator for the city. It continued to be a vital part of the city's economy through the 1950s, and some historically significant features exist from this mid-century era. The majority of the key features that contribute to the historic significance of the district, however, date from the first quarter of the twentieth century.

The Stockyards were founded in 1890, three miles north of downtown Fort Worth. Located along the historic Chisholm Trail, cattle were moved through the area on their way to railheads and markets to the north. With the advent of a local rail line, the site was ideal for cattle business. Before 1902, cattle were driven to the Stockyards, where they then were sold and loaded onto train cars and then shipped farther north to meatpacking plants. This system proved costly though, and Fort Worth courted large meat packing companies to locate near the Stockyards.

Growth in the Stockyards exploded in 1902 when the two-meatpacking giants - Armour and Swift - built their facilities just east of the core of the Stockyards. This led to exponential local economic and population growth in Fort Worth. These developments are also significant on a statewide level, as their arrival signals the beginning of modern industrialization in Texas. The Stock Exchange Building (1902) and the Coliseum (1908) were erected around that same time. The packing plants constituted an impressive massing of industry, with a fine-tuned processing system that encompassed many buildings. At its peak, the Swift plant alone occupied more than 1,000,000 square feet of floor space and employed over 4,000 employees.

World War I was a prosperous time for the Stockyards, when horse and mule sales expanded tremendously to meet the needs of the military. This is significant on a national level because Fort Worth was consistently ranked in the top-five livestock centers nationwide, which included Chicago, Omaha, Kansas City and St. Louis. The Horse and Mule Barns were built in the 1910s, and the commercial areas of Exchange Avenue and Main Street continued to grow to meet the needs of the Stockyard's employees and visitors. The commercial areas provided services, dining, entertainment and lodging.

At the peak of the Stockyards' prosperity, cattle pens stretched from Exchange Avenue north to 28th Street, covering more than 100 acres. The cattle pen complex was rectilinear in form, with occasional interruptions



Southeast view of the Swift offices with packaging plant in the background (ca. early 1900s).



Southwest view of the Exchange building in the historic core of the Stockyards (ca. 1910).

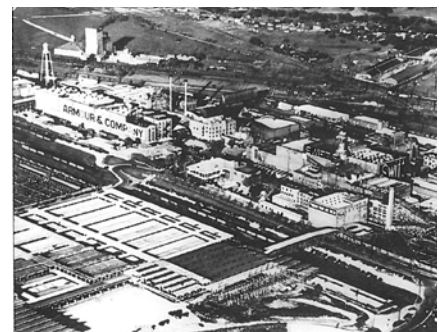

Northeast aerial view of the Armour and Swift meat-packing plants (ca. 1930s).



View of the east entry tower that frames Horse and Mule Alley. The eastern Horse and Mule Barns can be seen in the background.

of rail spurs, commissary huts and hay sheds. It was oriented around a grid of walkways and animal runs, all organized along north-south and east-west axes. Notable axes included cattle runway ramps that led cattle into the packing plants, and a “subway” which ran north-south and served the same function for sheep and pigs.

As the meat packing industry became more decentralized nationally and trucking supplanted rail transportation, the meatpacking plants and Stockyards began to decline. Armour closed its complex in 1962, and Swift followed seven years later.

Historic photographs and insurance maps document the early development framework of the Stockyards area, including the different functional zones and site features that existed, as well as the supporting circulation systems. The following maps outline important points in the historic development of the Stockyards area and provide an understanding of some of the historic features that survive today.

HISTORIC DEVELOPMENT PATTERNS: 1911

A Sanborn fire insurance map from 1911 shows the core of the Stockyards as being well established by that time. At the center stood the Coliseum and Stock Exchange buildings. These were set back from Exchange, with large lawns in front. Just to the west of these buildings, commercial storefronts were erected, positioned at the sidewalk edge.

West Exchange (location A on the map on the following page) developed in a similar manner, with buildings of predominately masonry construction that stood between 1 and 3 stories in height. Similar buildings extended North and South along Main Street, from the intersection of Exchange and Main. Wood frame canopies were common on the commercial buildings along both streets.

To the East and North of the Stock Exchange building, cattle pens (B) extended up toward 28th Street, but some land remained vacant in the northwestern quadrant. The cattle pens were arranged in a rectilinear pattern and were framed by the “subway” (hog and sheep run) to the east. Early photographs document that the pens were constructed of wood fencing and braced with steel gusset plates. Walkways, or cattle runs, also were laid out in a grid and provided a means of moving selected groups of livestock through the network of pens. A few buildings also appear in the pens area in the Sanborn map. Among these were hay sheds, a quarantine building, scale houses and shelters for sales agents.

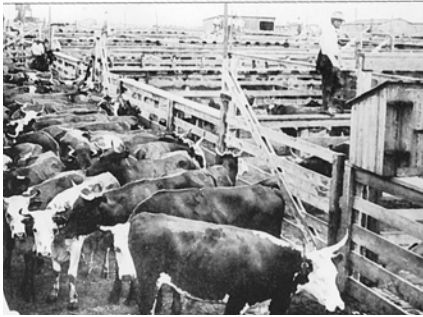

Cattle pen area showing wood and steel gusset fencing.

South of Exchange Avenue, the map shows only a portion of a set of hog and sheep pens. This first “module” of those pens was positioned along the sheep subway, which paralleled the rail yards farther east.

Along the east edge of the Stockyards complex stood the two-meatpacking plants. There were numerous buildings, which were laid out in a north-south orientation, creating distinctive lines of building walls with open spaces in between where rail spurs (C) ran. The greatest concentration of these buildings was at the center of these sites. The structures along the western edge were lower in scale, with more open space in between.



The entry of the Stockyards Club which once was located at the corner of Main Street and Exchange Avenue.



Sanborn Insurance Maps document primary building materials: masonry (including brick and stucco) is shown in red, while frame construction appears in yellow. Metal buildings have a blue color. This 1911 Sanborn map shows a mixture of masonry and wood frame buildings, with only one metal building by the rail yards. Note that no buildings appear for a portion of the area south of Exchange Avenue.

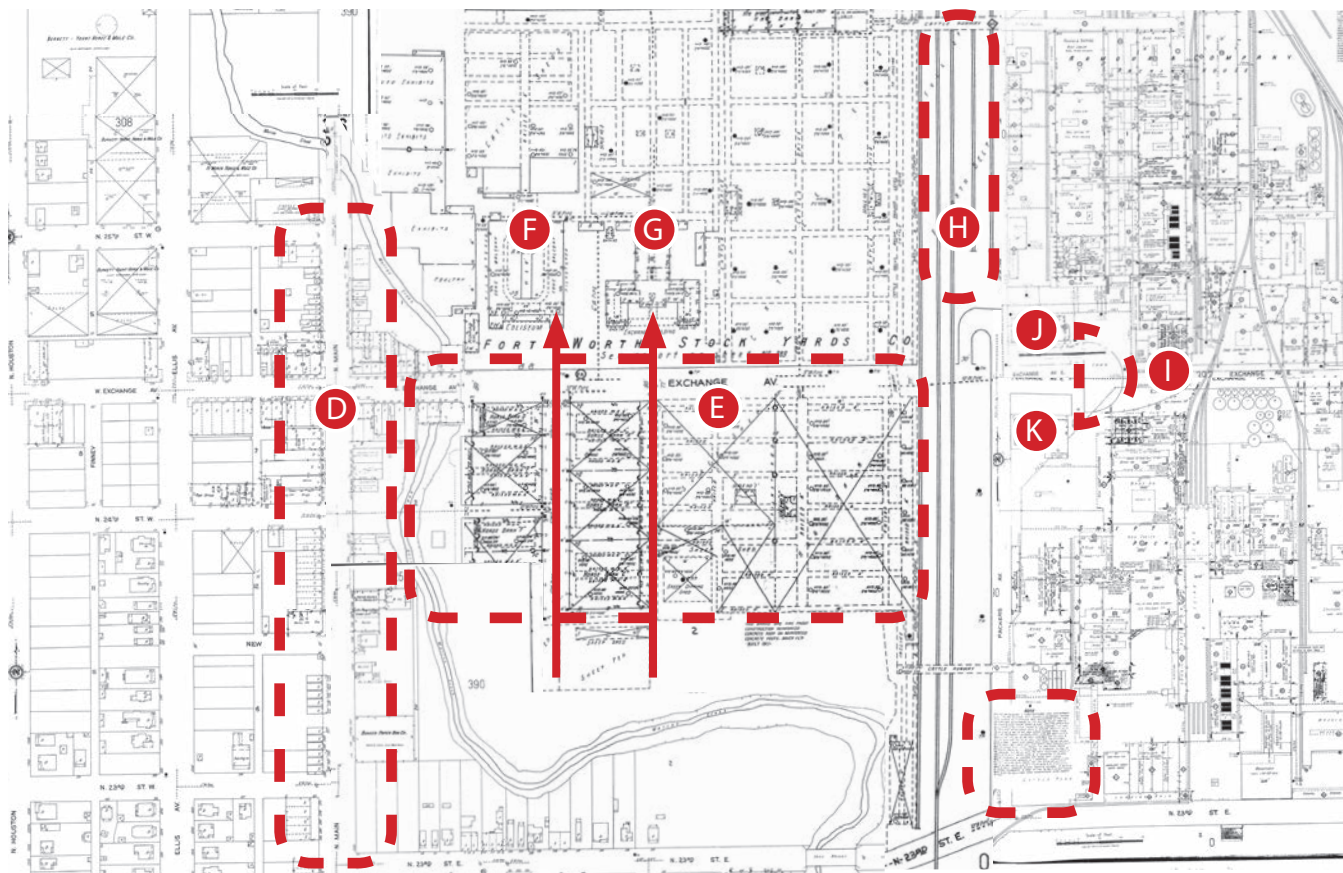

Sanborn Map from 1927

HISTORIC DEVELOPMENT PATTERNS: 1927

A later Sanborn Map, from 1927, shows further development: Main and Exchange were lined with more commercial buildings, all built to the edge of the sidewalks (location D on the map above). Many of these structures had traditional storefronts with recessed entries, display windows and transoms above.

By this time, the grid of cattle pens extended all the way to 28th and also had filled in farther west to Main. Cattle sheds had been erected just north of the Coliseum, again following the grid.

The rectilinear pattern of the cattle pens area also was repeated in the layout of the Horse and Mule Barns as well as hog and sheep barns and pens (E). The maps now show a more complete set of pens along

the southern edge of Exchange. These established a clearly defined edge to the sidewalk on this side of the street.

While buildings aligned along the rectilinear system of streets, cattle runs and rail lines, this pattern changed along the edge of Marine Creek. There, buildings created more of a “sawtooth” edge, as simple rectilinear structures were set back to follow the meandering contours of the creek bank.

Key north-south sight lines existed along streets, alleys and livestock runways, some of which terminated at the Coliseum (F) and Exchange Building (G). Other sight lines existed in an east-west orientation, notably along Exchange Avenue, where views to the east terminated at the Swift/Armour stairs, with the administration buildings and the taller meatpacking structures serving as a backdrop.

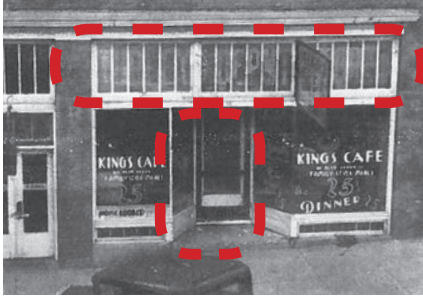

Traditional Main Street storefront with recessed entry and transom.



Early hog & sheep barns and pens were roofed with a "Y" frame construction with clerestories for sunlight and air flow (E).

Early photographs also help to document building heights: In the meat packing area, buildings decreased in massing and had less site coverage toward the rail yards (H) to the west. That is, lower scaled buildings, such as the Armour (J) and Swift (K) administration buildings, appeared along the western edge of the meat packing area. This was a key feature of the historic development patterns in this area. Several open/lawn spaces (I) also existed on this west edge of the meat packing area and also contributed to its historic character.

HISTORIC DEVELOPMENT PATTERNS: 1951

By 1951, documentation shows that the cattle pens now extended all the way north to 28th, where a loading area for trucks existed. The rectilinear pattern of pens and livestock runs remained consistent throughout this area with the occasional exceptions of an individual building and a rail spur, as noted earlier (location L on the map on the following page).

The rail yards (M) created a swath of open space between the meat packing plants and the core of the Stockyards. A "wishbone" of rail spurs also was a particularly distinctive feature (N) in the meat packing area at this time.

One other change is the footprint of a set of exhibit buildings that stood along the eastern edge of Marine Creek, just north of Exchange. These now had a wedge-shaped form that followed a retaining wall on part of the creek. Aerial photos show that, south of Exchange, the creek edge remained informal and tree-lined.

THE STOCKYARDS TODAY

Today, the Stockyards Historic District is highly significant because it contains industrial buildings associated with the meatpacking, remnants of scale houses and holding pens for livestock, and an outstanding collection of commercial buildings erected in response to the construction of the meatpacking plants. The commercial buildings, originally incorporated as North Fort Worth and later as Niles City, are, essentially, a central business district that provided for the business demands of this distinct area. The Historic District still contains a wealth of resources associated with several historic themes of significance, such as architecture, agriculture, commerce, and industry.



Buildings at the two meat packing plants step down in scale along the eastern edge (M).

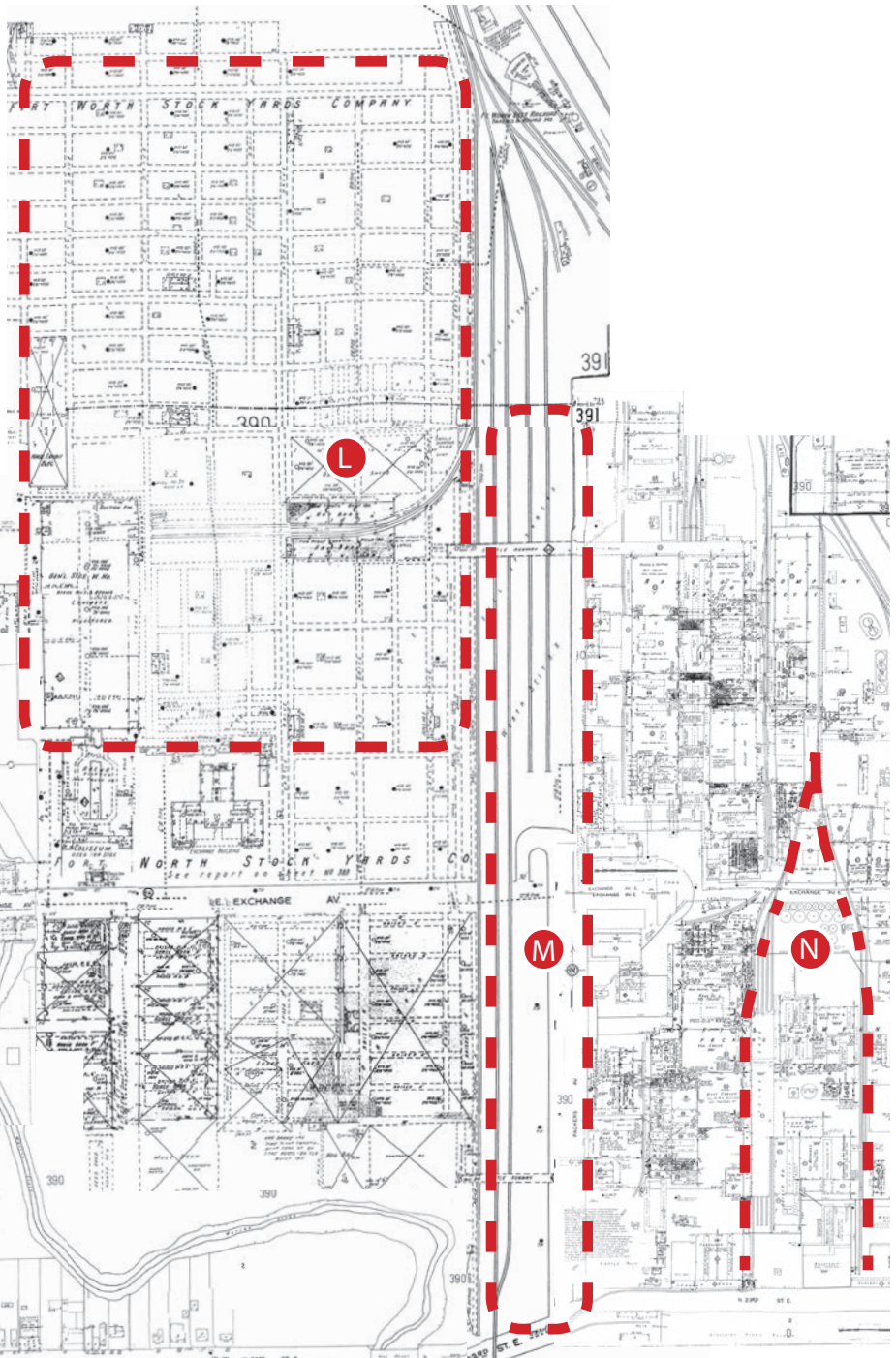

Sanborn Map from 1951



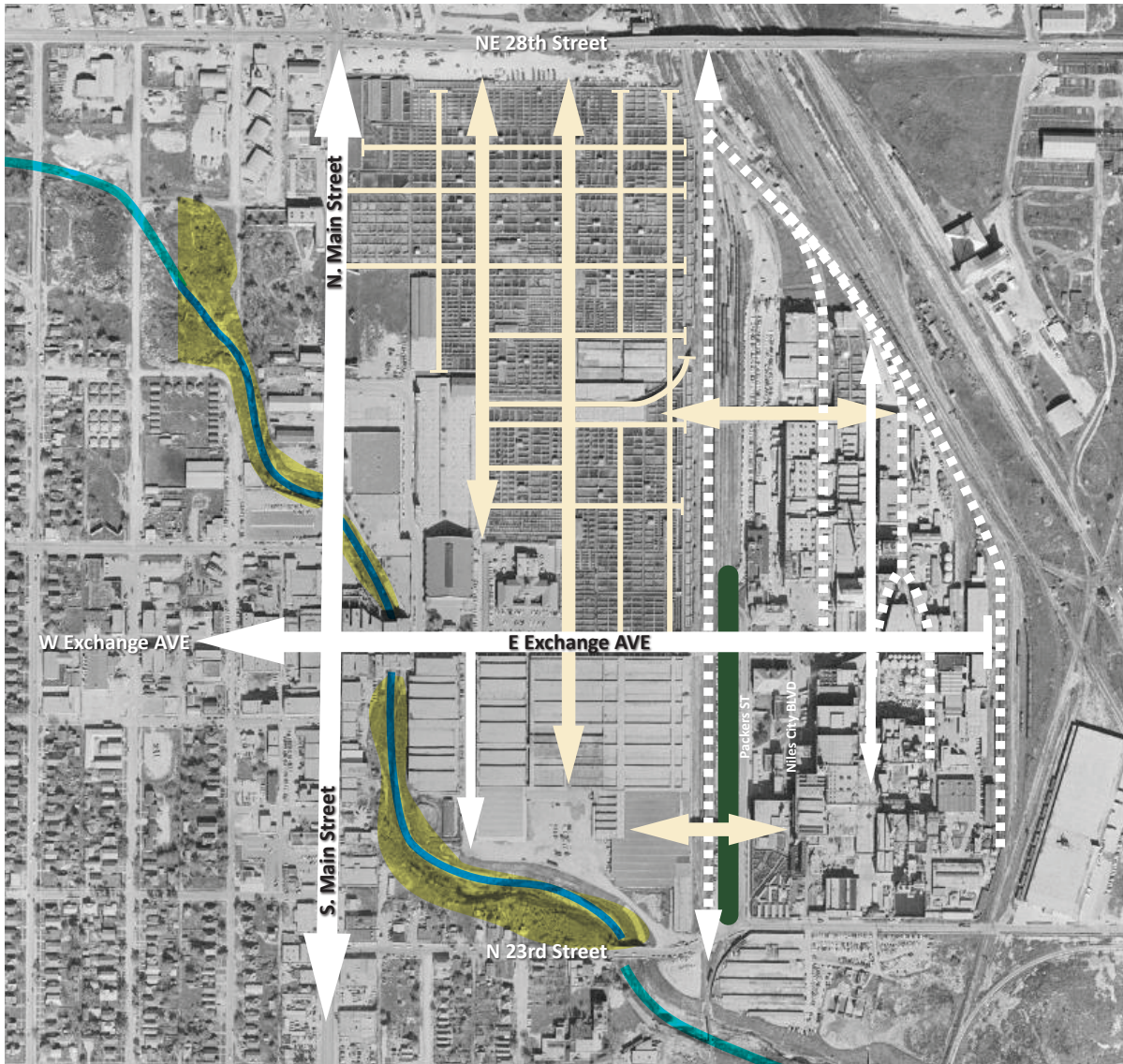

Circulation and Access Patterns



Aerial photo: 1957

Many key circulation routes existed historically in the Stockyards. These circulation routes should be respected by future development whenever feasible. These circulation corridors are shown in the map above.

KEY:

-  Livestock Walkways
-  Streets
-  Rail Lines
-  Heritage Tree Lawn

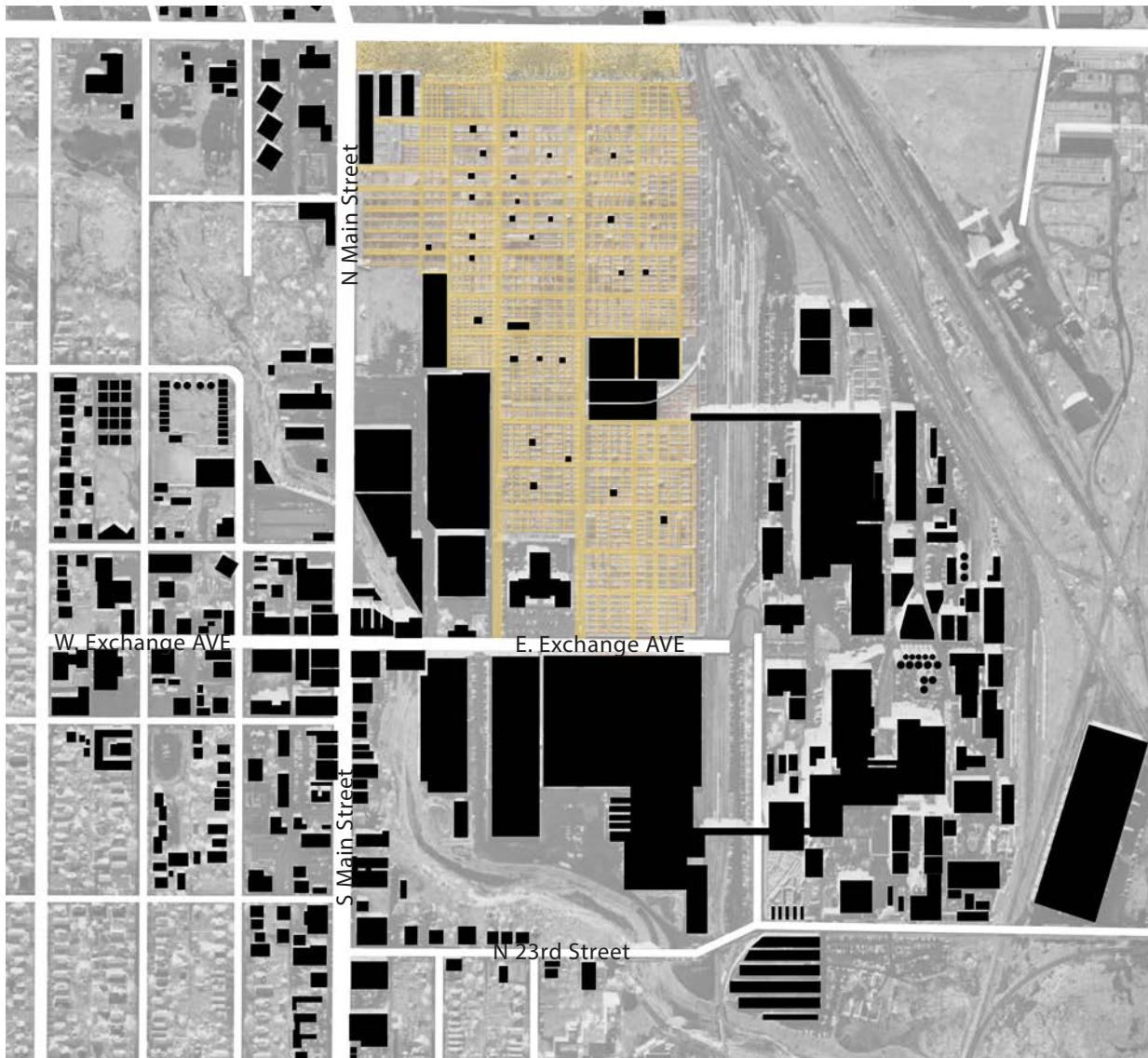

Historic Figure-Ground Patterns



Aerial photo: 1957

In this illustration, all roof structures that existed in 1957 are shown in black. This highlights the differences in form and scale of individual buildings. Livestock walkways and open pens are shown in the map above and documents the finer-grained texture of the stockyards themselves.

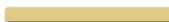
KEY:

-  Livestock Walkways and Fencelines
-  Streets
-  Buildings

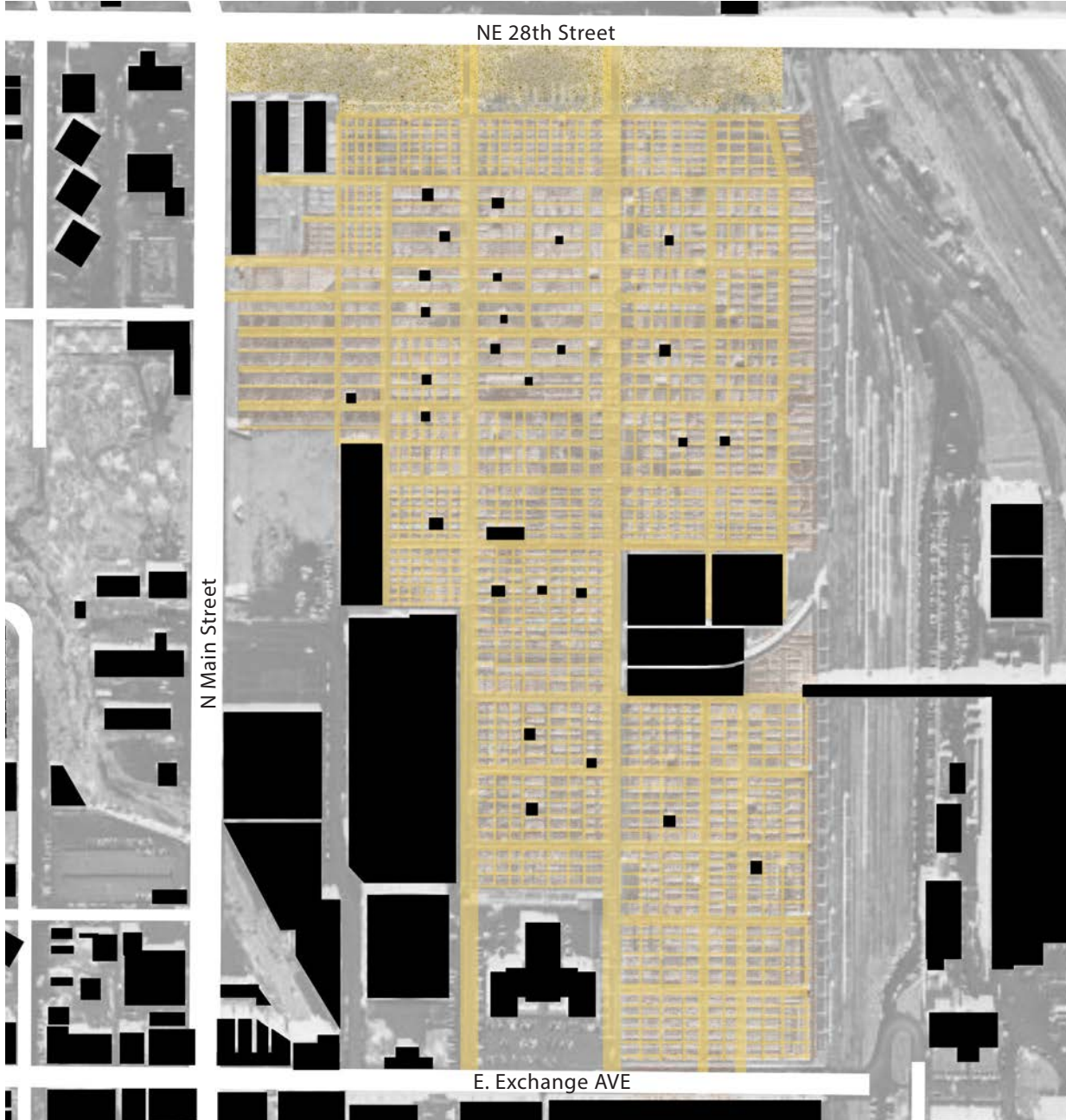

DETAILS OF HISTORIC FIGURE-GROUND PATTERNS



Aerial photo: 1957

In a closer view, the roofs of small structures, including scale houses and commission agent shelters, appear more clearly. These may provide inspiration for new site furnishing structures, such as vending kiosks and seating areas.

KEY:

-  Livestock Walkways and Fencelines
-  Streets
-  Buildings

Character Defining Features

This section describes some of the key features of the Stockyards Historic District that convey its significance as a major livestock center and meat producer for the United States. While some of the circulation patterns, landscapes and buildings described earlier have been altered; this section describes how those features are still relevant to the Historic District today. Other features that existed historically (and that are no longer present or that lie outside the Historic District) are described as well, because they help in understanding the significance of the features that do survive within the Historic District. Within the District, there are currently 54 architectural contributing resources. This lends a high degree of integrity to the District. This collection of resources is highly significant because it retains more historic buildings and site features than any other historic stockyards district in the United States. Note that a more detailed listing of key features in the Stockyards area may be found in a historic resources survey that was prepared by Historic Fort Worth, Inc. in 2016.

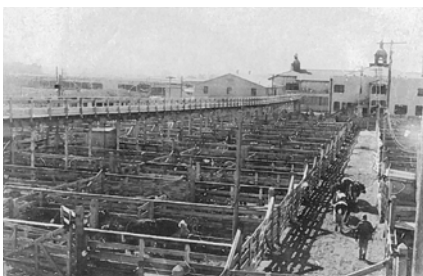

Stockyards employees lead cattle to a weigh station through the complex circulation system of pens.

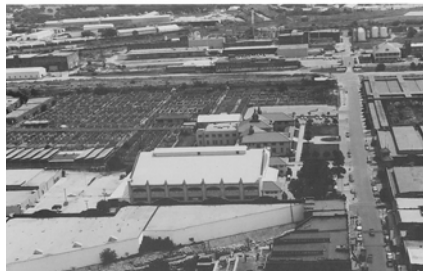

Trucks and autos traveled along Exchange Avenue.



Rail spurs wound through the packing plants, allowing loading of final products onto rail cars.

CIRCULATION PATTERNS

A critical aspect of the Stockyards was the need for orderly circulation throughout the site for pedestrians, animals and vehicles (including truck and train traffic). This consisted of a network of streets, sidewalks, walkways and ramps as well as rail lines.

Livestock Circulation

The Stockyards had an efficient circulation system for livestock. It consisted of a hierarchy of runs that provided ways to move cattle to and from the pens, through scale houses, to meat packing plants and, once processed, onto trains. The arrangement of the cattle pens determined the circulation routes for much of the livestock. Sitting north of Exchange Avenue, just to the east of the Exchange Building, walkways (runs) from the pens provided direct routes to ramps that led into the packing plants. The suppressed walk, or subway, was used to transport hogs and sheep to the ramps. Vestiges of this circulation system survive, including part of the subway, some ramps and the paved walkways once were framed with cattle pens. These remnants are key features.

Truck and Auto Circulation

Historically, truck and auto circulation was confined to the perimeter of the Stockyards, save for Exchange Avenue itself. Trucks typically unloaded at the northern end of the Stockyards. Streets in the commercial areas, to the west of the Stockyards, were laid out in an orderly grid pattern that accommodated vehicular movement. Exchange Avenue and Packers Street are historic alignments that survive and reflect this circulation system.

Rail Circulation

A key advantage of the layout of the Stockyards and packing plants was that they had direct access to a railroad. Spurs wound through the packing plants, allowing loading of products onto rail cars. Remnants of rail lines and railroad beds survive in some locations and are key features.

Pedestrian Circulation

Pedestrian circulation systems also were important to the Stockyards operations. In the early days, meat packing workers often commuted by streetcar, which delivered them to the base of the Swift/Armour staircase at the end of Exchange Avenue and thus into the system of walkways that existed. Other workers and stockyards patrons arrived by car. In each case, they then entered a system of sidewalks and special paths that afforded access to events, goods and services in the area. Livestock buyers and sellers moved through the pens on elevated walkways, which facilitated inspection of the cattle.

Sidewalks along Main Street and Exchange Avenue also were key pedestrian corridors. They, along with numerous alleys, provided a rectilinear network that served cattlemen, visitors and workers. Those sidewalks and related pathways that survive contribute to the historic significance of the area.

LANDSCAPE AND SITE FEATURES

Numerous landscape and site features existed throughout the Stockyards area. These are some key features:

Formal Landscapes

While most of the open spaces were working places, a few “formal” landscapes also existed. The most noteworthy of these were the lawns in front of the Exchange Building and the Coliseum. These were relatively simple grassy areas that were framed, in part, by low hedges and fences. While these lawns and fences have been altered since their original form, they still exist and convey some of their original character. They are significant features. Another historic landscape is the tree lawn that runs along the western edge of Packers Street.

Industrial Features and Historic Stairs

The Exchange Avenue Stairs and Armour & Swift Plaza were historic landscape features of the Packing Area. The stairs scaled a sloped embankment that also supported letters that spelled out the names “Armour” and “Swift.” An open space located between the administration buildings for Armour and Swift also was a noteworthy landscape feature. Another open space was located to the west of the meat packing plants,



The Main Street commercial area was a primary pedestrian corridor in the Stockyards Historic District.

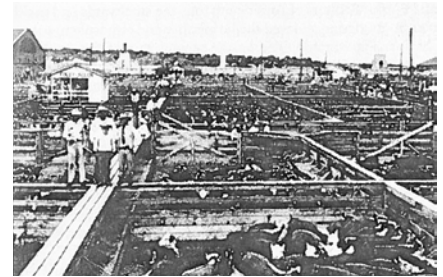

Company representatives stand on the elevated walkways above the pens, which allowed for easy inspection of the cattle below.



The historic Swift & Co. stairway once served as the south entrance to the Swift complex. This stairway still stands along 23rd Street and is landmarked.



Raised brick thoroughfares provided footing for animals as they were moved.

some of which was landscaped to create a formal entryway. In addition to the staircase at the end of Exchange Avenue, another staircase at 23rd Street provided access at the southern end of the Swift site. These stairs and related retaining walls survive and are key features. In addition, vestiges of the formally landscaped spaces remain as opportunities for restoration.

Livestock Runs, Paving and Pens

Livestock pens stood in a dense grid network west of the meat packing plants and north and east of the Coliseum and Exchange buildings. These were wood-framed fences that stood 5 to 6 feet tall. Raised walks throughout the pens allowed workers to oversee the livestock. The fencing was constructed of wood and braced with metal brackets. The pens had brick paving and the walkways connecting them did as well, using a different paving pattern, which provided better traction. Much of this brick paving survives and is a key feature. A portion of the wood frame cattle pens also survives just north of the Coliseum and is a key feature.

Roofed pens were located to the south of Exchange Avenue to hold sheep and pigs. These had clerestory windows. Brick paving was used for the pen floors as well as walkways here as well. A portion of these structures survives as Stockyards Station and is a key feature also.

Marine Creek

Marine Creek ran through the area, providing a source for water and creating a meandering edge for buildings and outdoor spaces that flanked it. This is a key feature and amenity for the area. Portions of the creek bank have been covered with stone that date from a more recent period. Just north of Exchange Avenue, the creek is more constrained with masonry retaining walls. Of special note is the masonry arch structure supports Exchange Avenue as it crosses the Creek. This also serves as the foundation for several buildings that span the Creek.

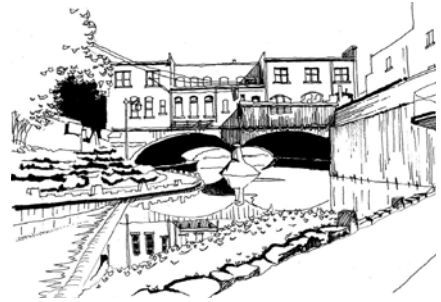

Marine Creek provides a natural buffer to the Stockyards and commercial area, and creates outdoor spaces for pedestrians.

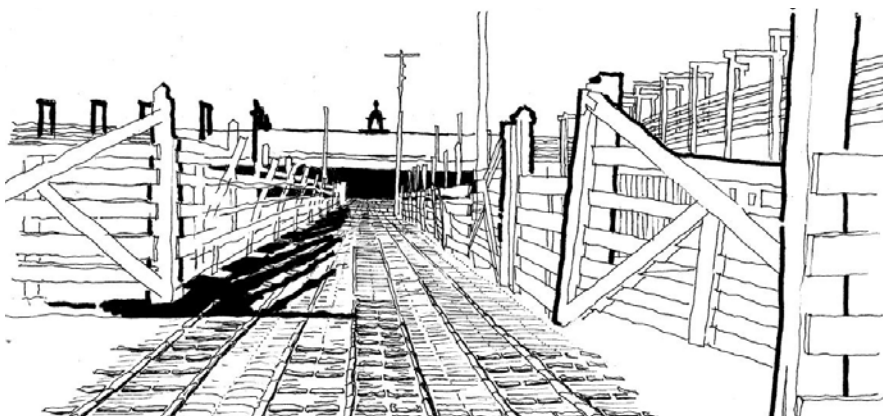

The Livestock area consisted of wood-framed fences that stood five to six feet tall and had brick pavers for flooring. Paving in the cattle runs had raised edges that provided better traction.

Other Site Features

Other noteworthy site features include ornamental columns on Main Street at the northern and southern gateways to the Stockyards, as well as a gateway arch that spans Exchange Avenue just east of Main Street. These are historically significant.

BUILDINGS

These are some of the noteworthy structures that make the Fort Worth Stockyards unique.

Industrial Buildings

Most buildings on the east side of Packers were industrial in character. These were primarily brick structures with heights that varied from 2 to 9-stories. Raised concrete foundations and cylindrical metal towers were also present in the Packing Area. Lower scale buildings and administrative offices were located along the western edge of the packing area while the height and intensity of the buildings increased to the east. Although few of these buildings survive, the Exchange Avenue Stairs/Armour & Swift Plaza, the Swift & Co. General Offices and the Armour Company-Blood Serum Albumin Plant still survive and contribute to the Historic District.

Commercial Buildings

The commercial area, which centered on Exchange and Main, consisted predominately of 1 and 2-story brick buildings. Stores and other businesses were located on the street level, while offices and residences were in the upper floors. Many of the historic commercial buildings survive and are key features of the Historic District.



Industrial meat processing buildings form the backdrop of the 2-story office of Swift and Company.

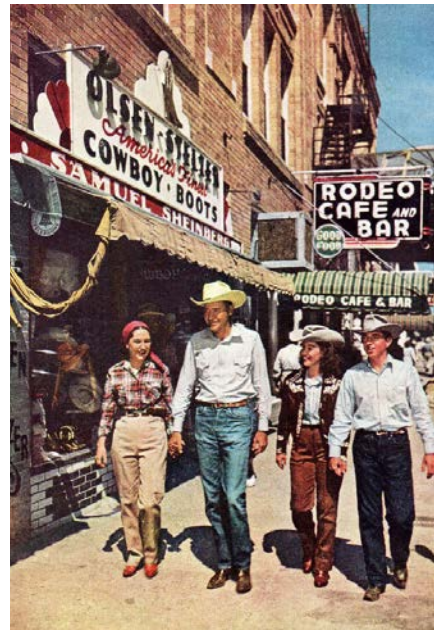

Traditionally, hotels, bars and restaurants had storefronts at the street level.



The meat packing area was the central location for the Stockyards workforce and consisted of buildings between 2 and 9 stories.

Exchange Building

The Livestock Exchange Building was built in 1902 and is at the center of the historic district. Designed in the Mission style, this structure is an early example of a design that was first introduced in California in the 1890s. The Exchange Building is the oldest building in the district that is still in use. Built in a U-shape out of stuccoed brick, the building's main facade has two projecting hip roofed end pavilions displaying at the center "Alamo" style parapets with Palladian windows. The building is further defined by small octagonal cupolas, a curvilinear parapet and a T-shaped, arcaded gallery.



The Livestock Exchange Building was built in 1902 and is at the center of the historic district. Designed in the Mission style, this structure is an early example of the design that was first introduced in California in the 1890s.

Coliseum Building

Adjacent to the Exchange Building is the 1908 Coliseum, built to display the livestock on sale. Ten years after its construction, the first indoor rodeo was held here. The Fort Worth Fat Stock Show was also a popular annual event and was held in this building until after World War II. This rectangular structure is flanked by two, one-story hipped roof wings, a connecting arcade gallery across the front and a second-story with several small windows and an arched opening. The original façade is obscured by an arcaded ticket booth entry that was added at a later date.



Adjacent to the Exchange Building is the 1908 Coliseum, built to display livestock on sale.

Two, large neighboring buildings also are associated with the stock shows and livestock trading. A triangular-shaped building to the west of the Coliseum once served as exhibit barns and another rectangular building to the north is the old auction barn. These also are historically significant as well.

Agricultural or Livestock Buildings

South of Exchange Avenue, across from the Exchange and Coliseum buildings stand the Horse and Mule Barns. The original barns, built before World War I, were destroyed by fire and the present buildings were constructed in 1912. They face onto a shared paved walkway, "Mule Alley". The entrance to this walkway from Exchange Avenue is marked by a pair of two-story towers, each with a round arched openings at the base and three small round arched openings on the second level. The towers are connected by a pitched, tile roof. Each barn entry is identified by a Mission-style parapet. This ensemble of structures, spaces and towers is a key landmark in the district.



The Coliseum and Exchange Buildings sit side by side on the north side of Exchange Avenue. A green lawn and rail fence are key features.

Further east along Exchange Avenue stands the Stockyards Station, which originally was a part of the hog and sheep barns and pens. This structure is noteworthy for its concrete structural system and clerestory windows. It retains much of its historic brick paving material and is a contributor to the historic district.



The entrance to the Horse and Mule Barns is marked by two two-story towers, each with round arched openings at the base and three small round arched openings on the second level.

View Opportunities

Many noteworthy views exist throughout the Stockyards area that enrich the experience of visitors, residents and employees. They offer opportunities to be used for more formally-organized interpretation programs, which could include historical markers and other “station points” to be used in walking tours and other heritage tourism events and activities.

Some of the key view opportunities are indicated on the View Opportunities Map on the following page. Many key view opportunities lie along public streets, while others are in places that may be included in new development projects. New plazas, courtyards, decks and other active outdoor use areas could be located to take advantage of these view opportunities and to aid in interpreting the heritage of the Stockyards. These view opportunities should be incorporated into public and private sector improvements to the extent feasible.

Station Points

The map identifies “station points” as places where an observer may stand to experience a specific view. These are identified with an “x” framed in a box. Station points are found along Exchange Avenue and Main Street and also along lines within the stockyards that once were defined by cattle runs and other walkways.

View Points

The object of a specific view is identified with a red asterisk.

View Cones

Other views are “cones,” which take in a wider expanse of features and landmarks. These are identified with a yellow fan-shaped symbol on the map.

View Corridors

View corridors are the sight lines from station points to specific view targets. These are identified with blue arrows on the map.

VIEW TARGETS

- T1. South entry piers on Main Street
- T2. North entry piers on Main Street
- T3. Stockyards arch on Exchange Avenue
- T4. Archway to Mule Alley
- T5. Towers (cupolas) on the Coliseum
- T6. Scale house #1
- T7. Cattle run
- T8. Scale house #2
- T9. Towers on the Exchange Building
- T10. View to sheep and hog sheds (Stockyards Station)
- T11. Armour/Swift stairs
- T12. Swift Administration building
- T13. Armour Laboratory & Storage building
- T14. Swift south entry stairs
- T15. Arches of Main Street buildings/bridge
- T16. View to Marine Creek from Mule Alley

View Cones

- C1. View looking east along Exchange Avenue to historic commercial building and to the Stockyards gateway arch beyond
- C2. View of south entry piers and flanking historic commercial buildings
- C3. View of north entry piers and Billy Bob's beyond
- C4. View of the historic structures in the core of the historic stockyards district with downtown Fort Worth in the distance
- C5. View from Exchange Avenue to the towers (cupolas) on the Exchange Building
- C6. View from Exchange Avenue to the Armour/Swift stairs and historic meat packing buildings
- C7. View along historic eastern end of Exchange Avenue to the Armour/Swift stairs, Exchange Avenue and the gateway arch

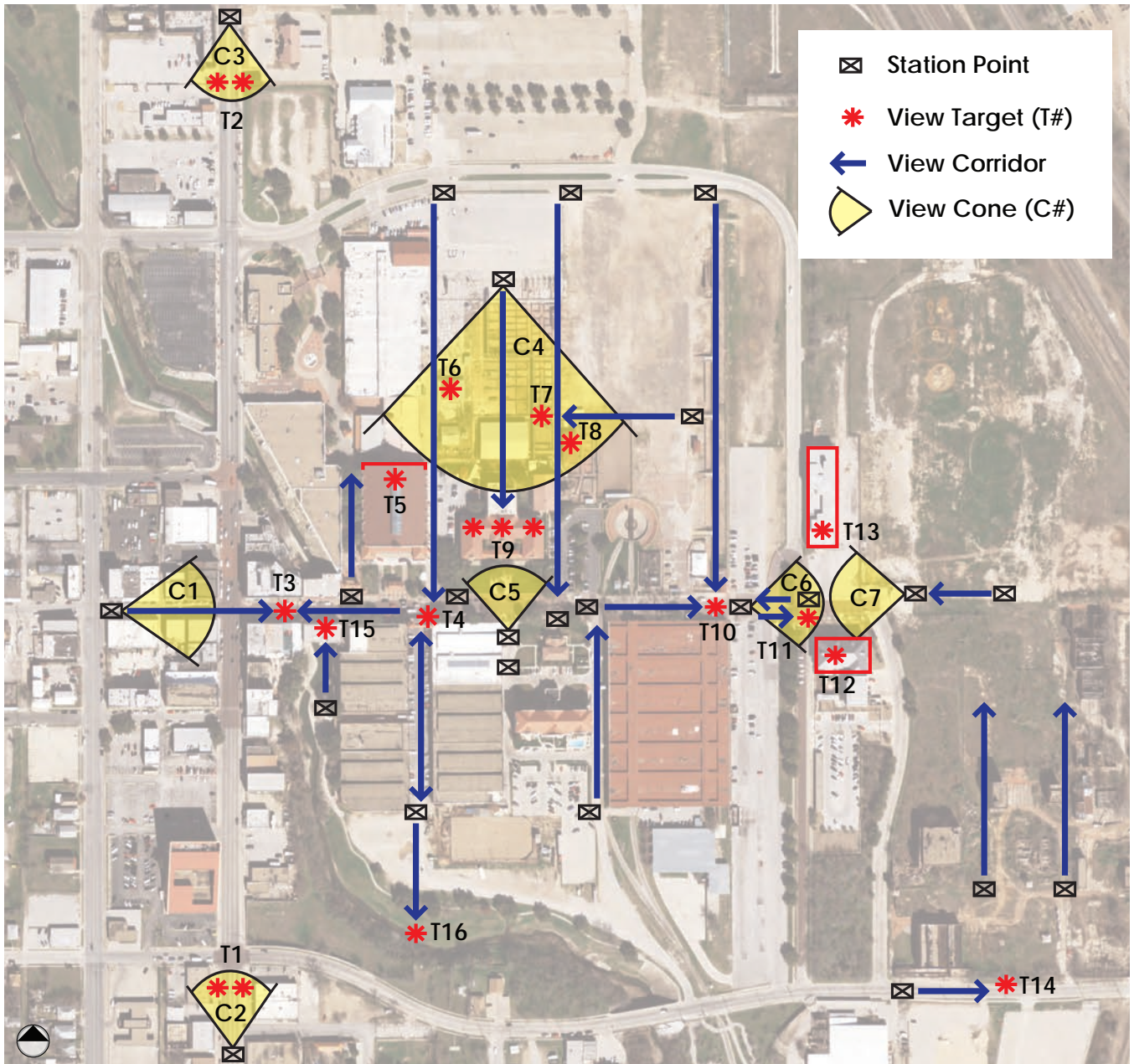

View Opportunities Map



Views from within View Cone 4 (C4), looking south towards the Coliseum and Exchange Building.

HOW TO USE THIS DOCUMENT

1. Determine Your District

2. District Standards

- Lot Size
- Building Setbacks
- Building Height
- Roof Form
- Building Form
- Articulation

3. Frontage Standards

- Build-to Zones
- Front Setback
- Parking Setbacks
- Transparency
- Story Height
- Pedestrian Access
- Building Elements

4. Design Guidelines

5. Other Rules

6. Streets

- Applicability
- Dimensional Standards
- Future Streets & Pathways
- Street & Pathways Types

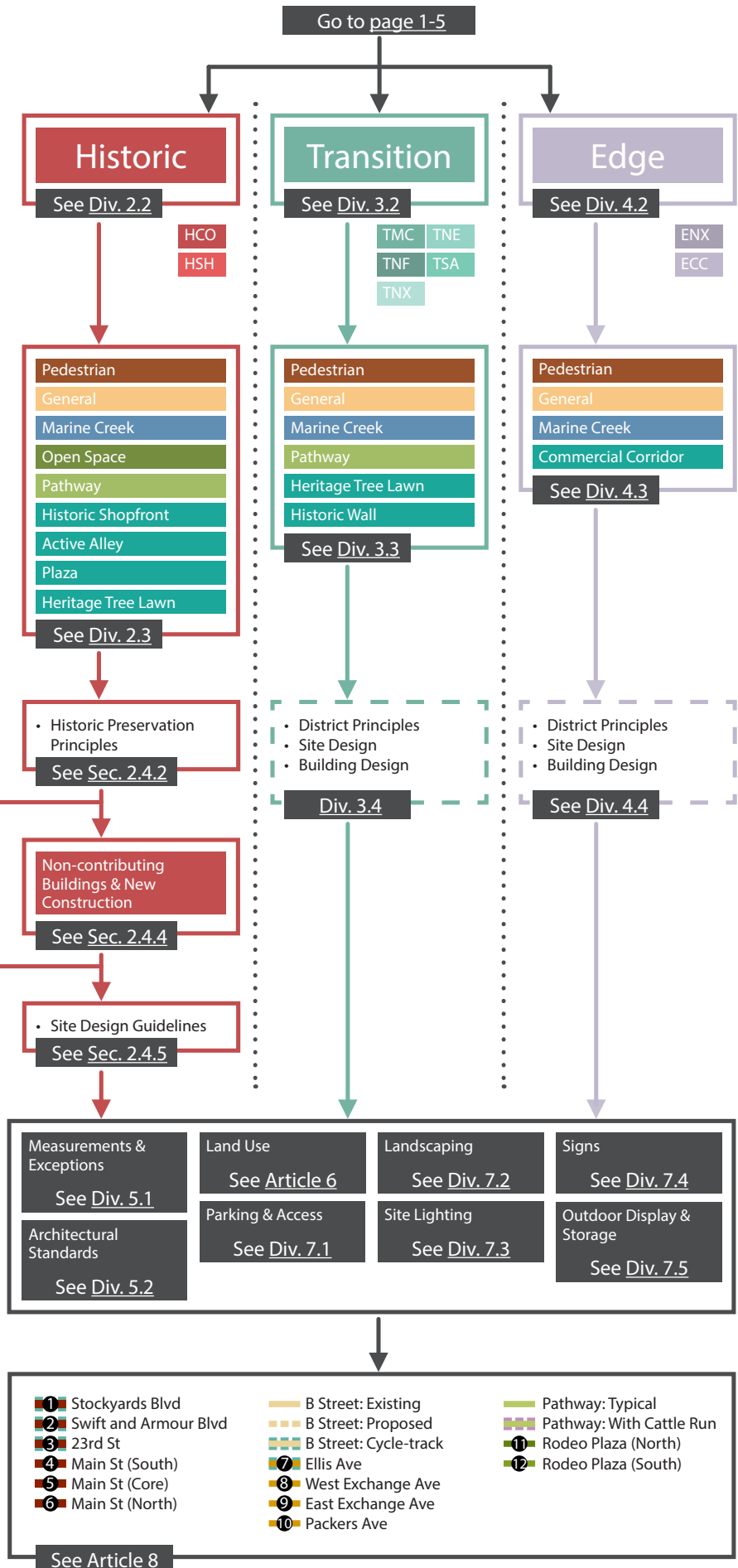

ARTICLE 1. OPENING PROVISIONS

| | |
|--|-----|
| Div. 1.1. Legal Requirements | 1-2 |
| Sec. 1.1.1. Title | 1-2 |
| Sec. 1.1.2. Effective Date | 1-2 |
| Sec. 1.1.3. Purpose | 1-2 |
| Sec. 1.1.4. Intent | 1-2 |
| Sec. 1.1.5. Applicability | 1-3 |
| Sec. 1.1.6. Conflicting Provisions | 1-3 |
| | |
| Div. 1.2. Districts..... | 1-4 |
| Sec. 1.2.1. Naming Convention | 1-4 |
| Sec. 1.2.2. Districts Established | 1-4 |
| | |
| Div. 1.3. Frontages | 1-4 |
| Sec. 1.3.1. Description | 1-4 |
| Sec. 1.3.2. Frontages Established | 1-4 |
| | |
| Div. 1.4. District and Frontage Map..... | 1-5 |

Div. 1.1. Legal Requirements

Sec. 1.1.1. Title

This document is the “Stockyards Form-Based Code and Design Guidelines,” and is referred to or cited throughout this document as this "Code."

Sec. 1.1.2. Effective Date

This Code was adopted on May 02, 2017 and became effective on August 24, 2017.

Sec. 1.1.3. Purpose

- A. This Code was prepared to provide development standards for the Stockyards area, a mixed-use growth area within the City of Fort Worth.
- B. This Code provides the means to guide implementation of the citizen-endorsed concepts of the Stockyards Charrette Report dated September 22, 2016.
- C. The Stockyards Charrette Report describes a series of character areas that have been refined to provide the basis for development standards in this area. One of the key concepts is that the level of design review and the specificity of development standards should reflect the need to:
 - 1. Protect the local historic district;
 - 2. Respond to the historic context and patterns when developing new buildings and sites in the transition areas; and
 - 3. Treat the edge areas in a manner similar to other similar locations in the City.
- D. This Code helps to foster predictable results and a high-quality public realm by prescribing the physical form of buildings and other site elements and addressing the relationship between buildings and the public realm, the form and mass of buildings in relation to one another, and the scale and types of streets and blocks.

Sec. 1.1.4. Intent

- A. This Code is intended to balance historic preservation and development by:
 - 1. Ensuring continuation of the authenticity of the Stockyards as a part of the National Register of Historic Places (listed in 1976), and as the Fort Worth Stockyards Historic and Cultural Landmarks District (a local Historic District designated in 2016).
 - 2. Applying development standards and design guidelines to promote rehabilitation and redevelopment that is sensitive to the surrounding historic context.
 - 3. Preserving existing buildings and guiding compatible redevelopment to help promote cultural, environmental and economic sustainability.
 - 4. Acknowledging circulation patterns, landscapes and site features, and buildings and structures that existed during earlier periods of significance on the site, in order to allow interpretation of these older patterns in the future as the area grows.
- B. This Code is intended to achieve design excellence in the built environment by:
 - 1. Providing building and site design standards that address the public aspects of private development and how building form, placement, and uses contribute to the quality of the public realm.
 - 2. Providing parking and access standards that appropriately balance pedestrian and vehicular needs and result in safe pedestrian environments of the highest quality.
 - 3. Promoting innovative landscape and building design that advance the function and beauty of Fort Worth, while respecting the historic character of the Stockyards area.

- C. This Code is intended to guide Fort Worth's prosperous and sustainable future by providing clear development standards and processes that result in predictable, efficient and coordinated review processes.

Sec. 1.1.5. Applicability

This Code applies to all property as shown in [Div. 1.4](#) and the City of Fort Worth Official Zoning Map.

Sec. 1.1.6. Conflicting Provisions

- A. Where the City of Fort Worth Zoning Ordinance conflicts with a standard set out in this Code, the standard in this Code controls.
- B. Illustrations, photographs and graphics are included in this Code to illustrate the intent and requirements of the text. In the case of a conflict between the text of this Code and any Illustrations, photographs and graphics, the text of this Code governs.

Div. 1.2. Districts

Sec. 1.2.1. Naming Convention

Each sub-district uses the following naming convention:

- A. First two letters = Stockyards Form-Based District
- B. Third letter = Character Area
 - 1. H = Historic
 - 2. T = Transition
 - 3. E = Edge
- C. Forth and fifth letters = Form and Use
- D. Final Number = Maximum Height in Feet
- E. EXAMPLE: SY-HSH-40
 Stockyards-Historic Shopfront-40 feet max height

Sec. 1.2.2. Districts Established

The following sub-districts are established and are shown on the map in [Div. 1.4](#).

- A. Historic Districts
 - 1. SY-HSH: Shopfront-40, -68
 - 2. SY-HCO: Core-40, -55, -60, -68
- B. Transition Districts
 - 1. SY-TMC: Marine Creek-68
 - 2. SY-TNF: North Forty-40, -55
 - 3. SY-TNX: Neighborhood Mixed Use-55, -80
 - 4. SY-TNE: Northern Edge-68, -105
 - 5. SY-TSA: Swift/Armour-55, -80, -105, -130
- C. Edge Districts
 - 1. SY-ENX: Neighborhood Mixed Use-40, -55
 - 2. SY-ECC: Commercial Corridor-68

Div. 1.3. Frontages

Sec. 1.3.1. Description

Frontages link a desired development pattern with specific form requirements that mandate the type of development desired along the street edge.

Sec. 1.3.2. Frontages Established

The following Frontages are established and are shown on the map in [Div. 1.4](#).

- A. Historic Frontages
 - 1. Pedestrian
 - 2. General
 - 3. Marine Creek
 - 4. Open Space
 - 5. Pathway
 - 6. Historic Shopfront
 - 7. Active Alley
 - 8. Plaza
 - 9. Heritage Tree Lawn
- B. Transition Frontages
 - 1. Pedestrian
 - 2. General
 - 3. Marine Creek
 - 4. Pathway
 - 5. Heritage Tree Lawn
 - 6. Historic Wall
- C. Edge Frontages
 - 1. Pedestrian
 - 2. General
 - 3. Marine Creek
 - 4. Commercial Corridor

ARTICLE 2. HISTORIC DISTRICT

| | |
|---|------|
| Div. 2.1. Description..... | 2-2 |
| Div. 2.2. Historic Sub-Districts | 2-3 |
| Sec. 2.2.1. Shopfront (SY-HSH) | 2-4 |
| Sec. 2.2.2. Core (SY-HCO) | 2-6 |
| Div. 2.3. Frontages | 2-8 |
| Sec. 2.3.1. Pedestrian | 2-9 |
| Sec. 2.3.2. General | 2-9 |
| Sec. 2.3.3. Marine Creek | 2-10 |
| Sec. 2.3.4. Open Space | 2-10 |
| Sec. 2.3.5. Pathway | 2-11 |
| Sec. 2.3.6. Historic Shopfront | 2-11 |
| Sec. 2.3.7. Active Alley | 2-12 |
| Sec. 2.3.8. Plaza | 2-12 |
| Sec. 2.3.9. Heritage Tree Lawn | 2-13 |
| Div. 2.4. Historic Design Guidelines | 2-14 |
| Sec. 2.4.1. Statement of Significance | 2-14 |
| Sec. 2.4.2. Historic Preservation Principles | 2-18 |
| Sec. 2.4.3. Standards and Guidelines for Contributing Buildings | 2-28 |
| Sec. 2.4.4. Standards and Guidelines for Non-Contributing Buildings and New Construction | 2-60 |
| Sec. 2.4.5. Standards and Guidelines for Site Design | 2-67 |

Div. 2.1. Description

The locally designated Fort Worth Stockyards Historic and Cultural Landmarks District constitutes the heart of the Stockyards area and its preservation is a high priority. Four sub-districts fit within the Historic District. These are defined to recognize different contexts, each with distinctive development patterns and historic resources. Each sub-district is designed to respond to those conditions and promote preservation of the historic significance of each of those individual contexts as well as of the Historic District as a whole.

The objective is to promote the rehabilitation of historic resources and to assure that new construction is compatible with the significance of the place.

There are several key principles of the Historic District. First is to assure preservation of historic structures including accommodating appropriate restoration, rehabilitation and reuse of existing buildings. All new construction or expansion is also assured to be low in scale and compatible in character with the existing historic fabric. And lastly, to accommodate enhancement of historically significant open spaces, including Rodeo Plaza and Mule Alley while preserving their integrity. The Historic District includes the following sub-districts:*

- 1. SY-HSH: Shopfront-40, -68
- 2. SY-HCO: Core-40, -55, -60, -68

*The number represents the maximum height allowed in feet for that sub-district.

This Article includes development standards (Div. 2.2 and Div. 2.3) that are mandatory and apply to all properties throughout the Historic District unless modified by the Historic and Cultural Landmark Commission, per § 4.401, Historic Preservation Overlay District, of the Code of Ordinances. All projects must meet the criteria for issuance of a Certificate of Appropriateness as provided in that section, and also must meet the applicable Historic Guidelines in Div. 2.4 of this document as determined by the Historic Preservation Officer and/or the Historic and Cultural Landmark Commission.

The historic guidelines for the Historic District work in concert with the standards to help protect the historic character of the area. The standards apply to all properties throughout the Historic District. However, the Historic and Cultural Landmark Commission may recommend a modification from some of the standards as part of the Certificate of Appropriateness approval process, when doing so would assure compliance with the relevant historic guidelines.



Div. 2.2. Historic Sub-Districts

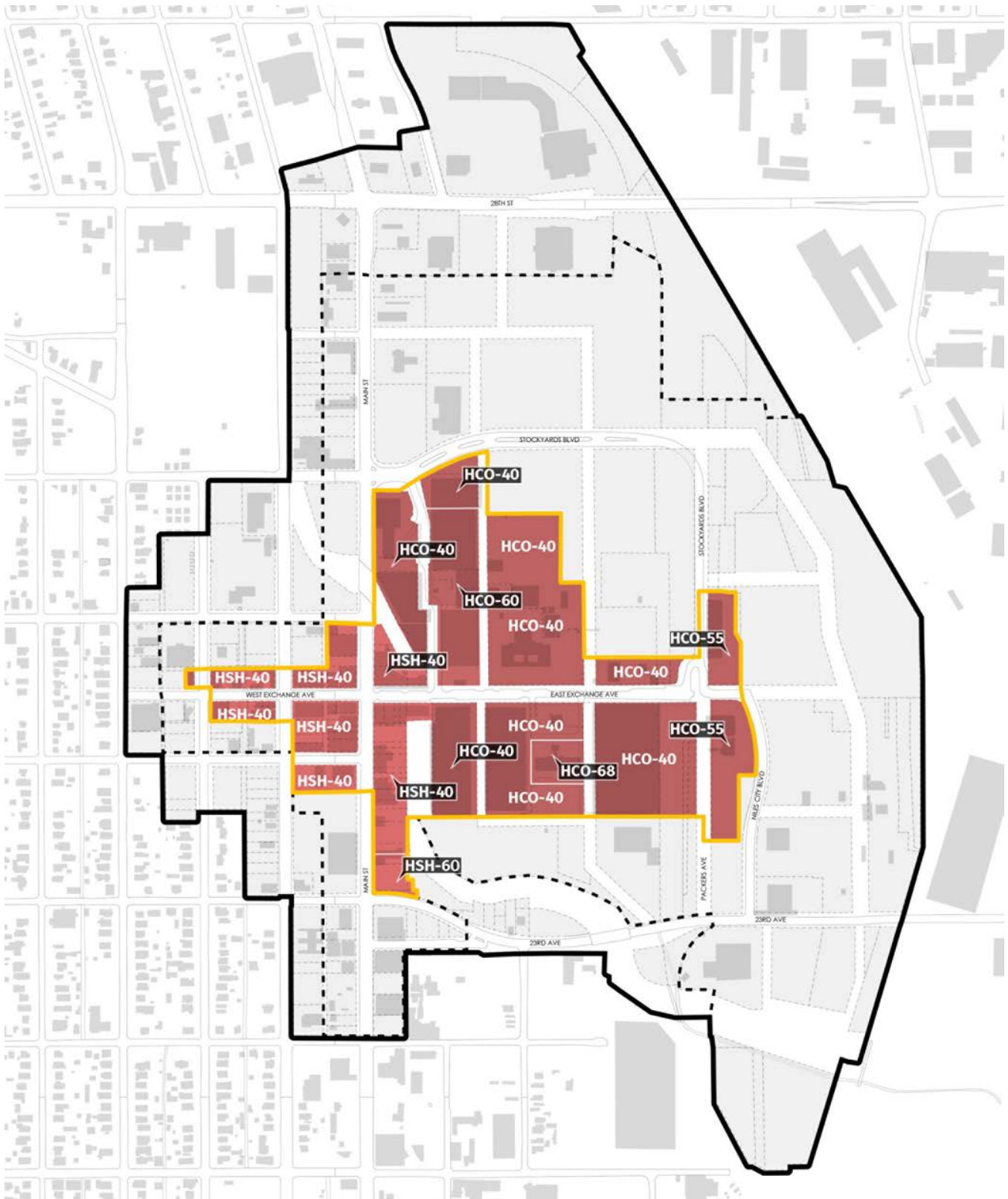

SEC. 2.2.1. SHOPFRONT (SY-HSH)



Intent

The Historic Shopfront District (SY-HSH) is defined by a context of historic commercial buildings. An objective of the SY-HSH District is to maintain the historic development patterns of the traditional commercial storefront structures by allowing buildings that will be compatible with the historic context, while doing so in ways that express their own time. This includes locating new building fronts to align at the sidewalk edge with a high percentage of display windows that permit views of activities inside and that enhance the area as a visually interesting place for pedestrians.

Applicable Districts

SY-HSH-40, SY-HSH-60

Use

Allowed uses See [Div. 6.1](#)

A. BUILDING PLACEMENT

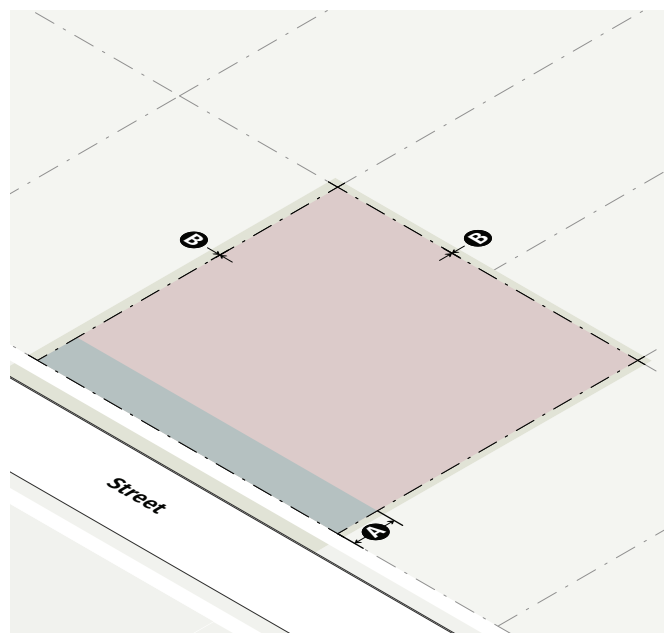

Lot

| | |
|-------|-----|
| Area | n/a |
| Width | n/a |

Building Setbacks

| | |
|--------------------------|--------------|
| A Front | see Frontage |
| B Common lot line | 0' min |
| Alley | 5' min |

B. BULK AND MASS

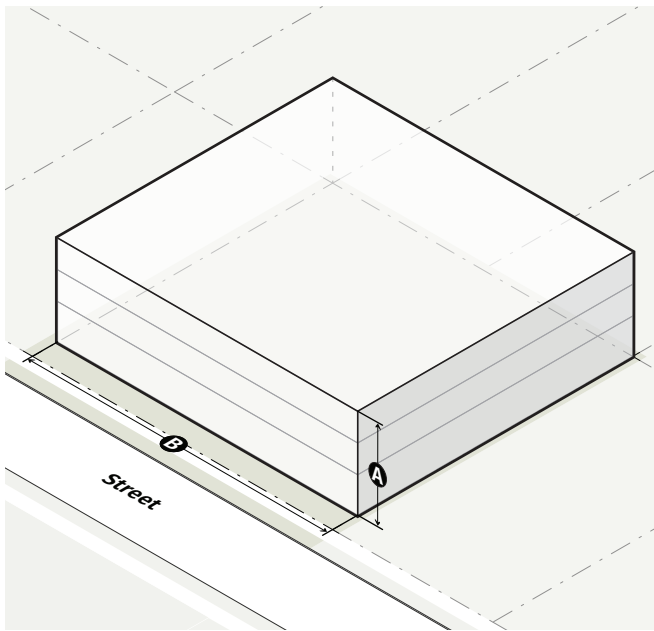

Building Height

| | |
|--|--------------------------------|
| A Maximum height | |
| SY-HSH-40 | 40' max |
| SY-HSH-68 | 68' max |
| B Minimum height | 2 stories of occupiable space |
| Roof Form | see Sec. 5.2.1 |
| Flat | Allowed |
| Traditional parapet | Allowed |
| Barrel vault | Not allowed |
| Gable: medium pitch | Not allowed |
| Gable: steep pitch | Not allowed |
| Hipped | Not allowed |
| Building Form | see Sec. 5.2.2 |
| C Street-facing building length | 150' max |
| Rectilinear building | Required |
| Angled, curved building | Not allowed |

C. FRONTAGE

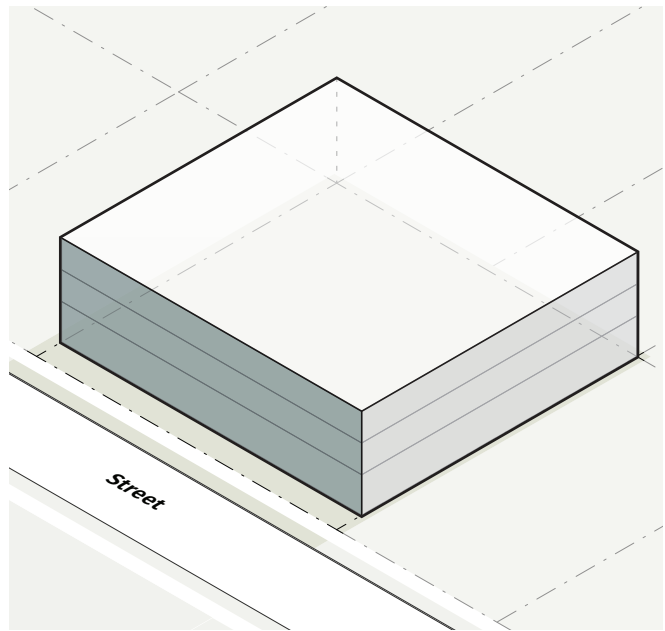

Applicable Frontages

see [Div. 2.3](#)

| | |
|--------------------|----|
| Pedestrian | ◇ |
| General | ◇ |
| Marine Creek | -- |
| Open Space | -- |
| Pathway | -- |
| Active Alley | -- |
| Historic Shopfront | ◇ |
| Heritage Tree Lawn | -- |

Building Materials

see [Sec. 5.2.4](#)

SEC. 2.2.2. CORE (SY-HCO)



Intent

The Historic Core District (SY-HCO) contains some of the most significant historic resources in the Historic District. Preservation of the integrity of these resources individually, and maintaining the sense of their relationship to each other, are of the highest priority. New development is intended to draw upon historic design precedents. These include the mass, scale, shape, roof form and palette of materials used. New development is intended to build on these traditions, while doing so in contemporary ways that express the evolving nature of the Historic District.

Applicable Districts

SY-HCO-40, SY-HCO-55, SY-HCO-60, SY-HCO-68

Use

Allowed uses see [Div. 6.1](#)

A. BUILDING PLACEMENT

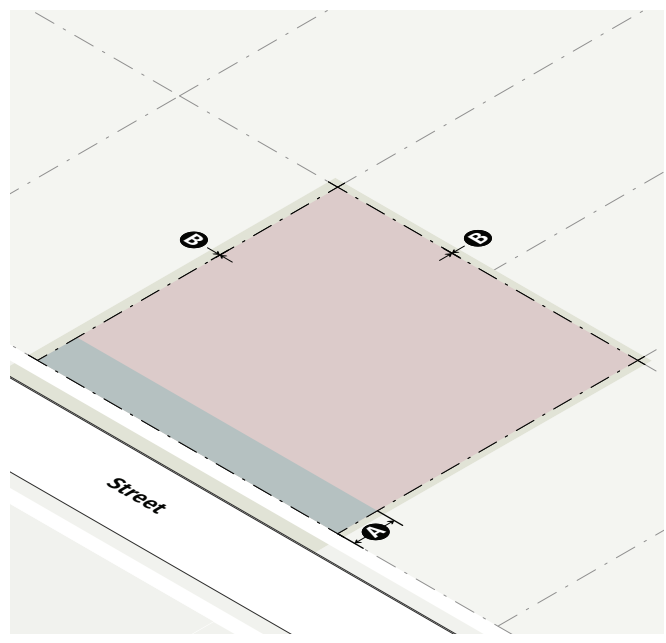

Lot

| | |
|-------|-----|
| Area | n/a |
| Width | n/a |

Building Setbacks

| | |
|--------------------------|--------------|
| A Front | see Frontage |
| B Common lot line | 0' min |
| Alley | 5' min |

B. BULK AND MASS

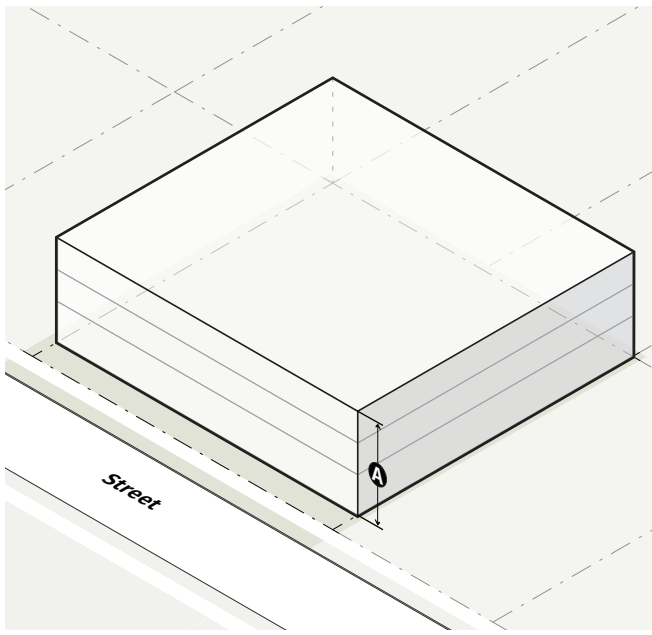

Building Height

| | |
|-------------------------------|--------------------------------|
| A Maximum height | |
| SY-HCO-40 | 40' max |
| SY-HCO-55 | 55' max |
| SY-HCO-60 | |
| Total building height | 60' max |
| Wall plate height | 40' max |
| SY-HCO-68 | 68' max |
| Minimum height | n/a |
| Roof Form | see Sec. 5.2.1 |
| Flat | Allowed |
| Traditional parapet | Allowed |
| Barrel vault | Not allowed |
| Gable: medium pitch | Allowed |
| Gable: steep pitch | Not allowed |
| Hipped | Allowed |
| Building Form | see Sec. 5.2.2 |
| Street-facing building length | n/a |
| Rectilinear building | Required |
| Angled, curved building | Not allowed |

C. FRONTAGE

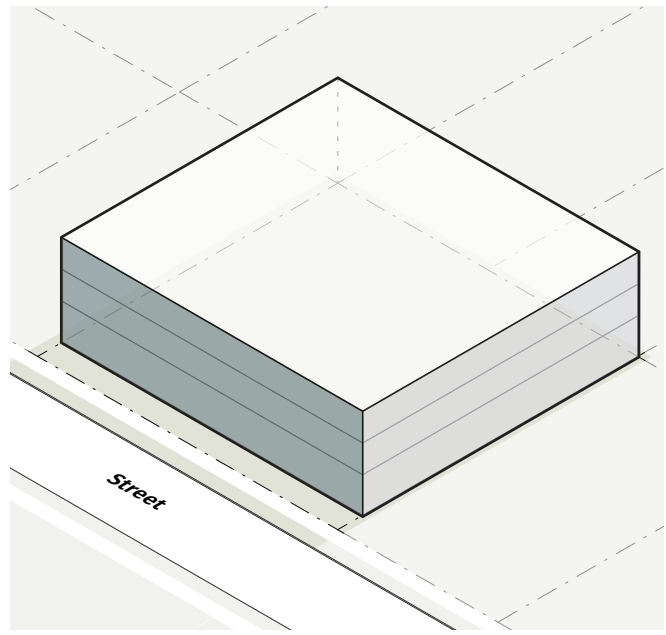

Applicable Frontages

see [Div. 2.3](#)

| | |
|--------------------|----|
| Pedestrian | ◇ |
| General | ◇ |
| Marine Creek | ◇ |
| Open Space | ◇ |
| Historic Shopfront | -- |
| Pathway | ◇ |
| Active Alley | ◇ |
| Plaza | ◇ |
| Heritage Tree Lawn | ◇ |

Building Materials

see [Sec. 5.2.4](#)

Div. 2.3. Frontages

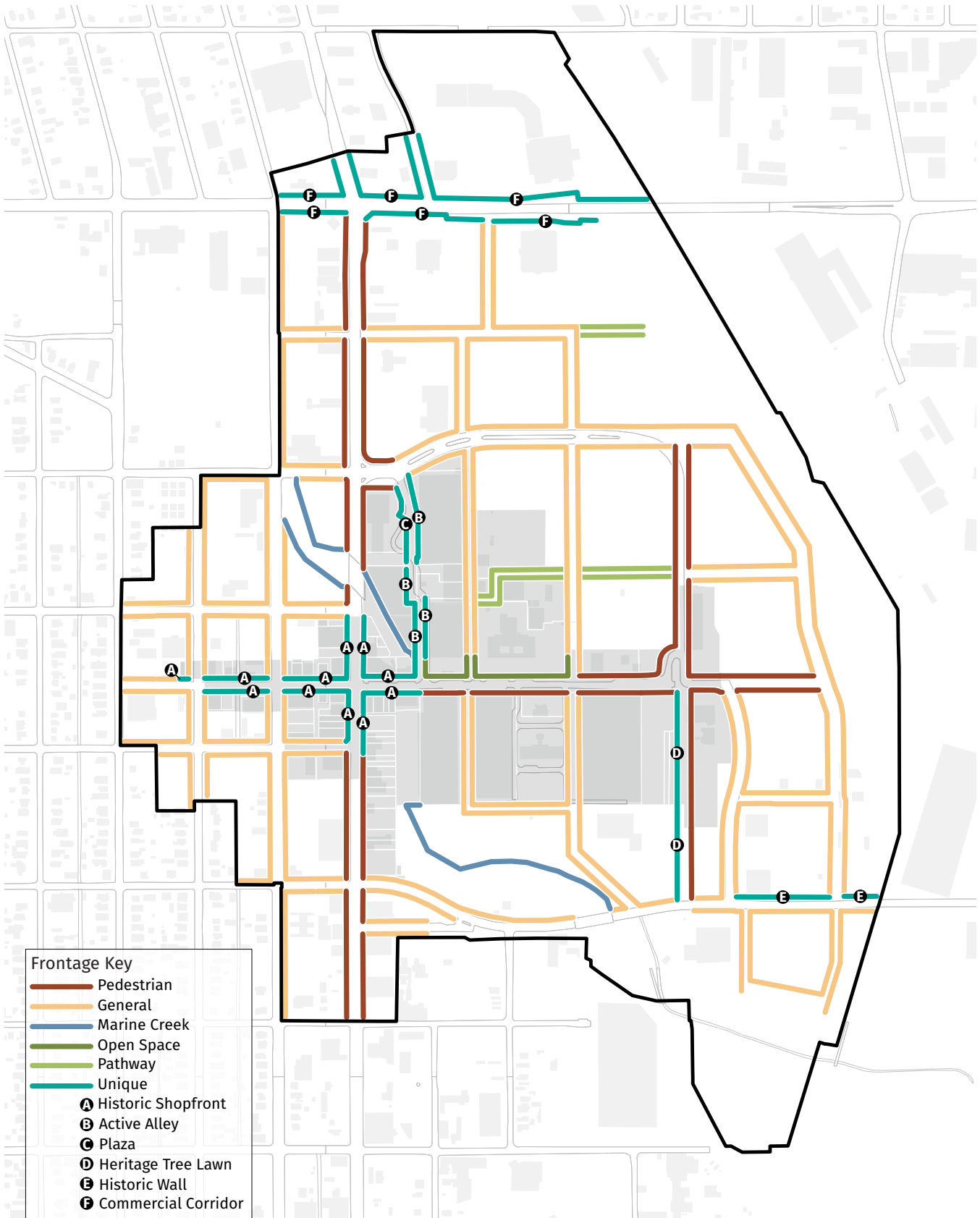

SEC. 2.3.1. PEDESTRIAN

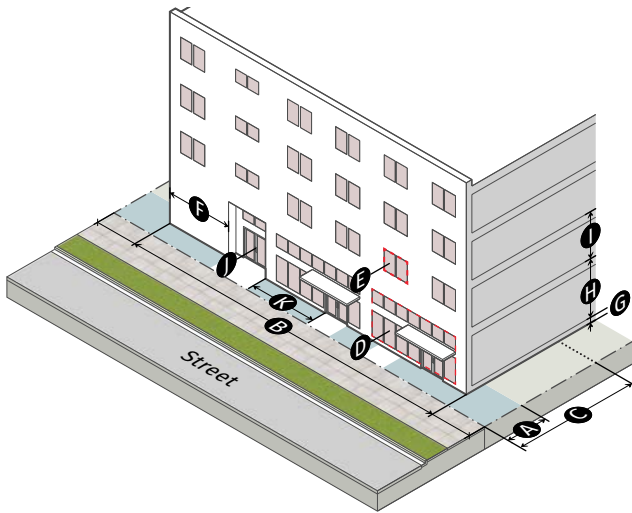

SEC. 2.3.2. GENERAL

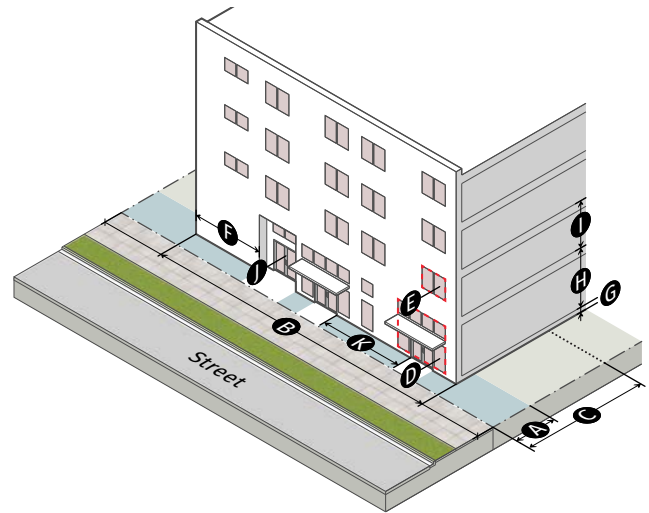

| Setbacks | |
|--|-------------------|
| A Build-to zone | 10' max |
| B % of building facade in build-to zone | 80% min |
| C Parking setback | 30' min |
| Transparency | |
| D Ground story | 70% min |
| E Upper story | 20% min |
| F Blank wall area | 20' max |
| Story Height | |
| G Ground floor elevation | 0' min/2' max |
| H Ground story | 14' min |
| I Upper story | 9' min |
| Pedestrian Access | |
| J Entrance facing street | Required |
| K Entrance spacing along street | 50' max |
| Building Elements | |
| | <u>Sec. 5.1.4</u> |
| Awning/canopy | ◇ |
| Balcony | ◇ |
| Forecourt | -- |
| Gallery | ◇ |
| Porch | -- |
| Stoop | -- |

| Setbacks | |
|--|-------------------|
| A Build-to zone | 10' max |
| B % of building facade in build-to zone | 70% min |
| C Parking setback | 30' min |
| Transparency | |
| D Ground story | 50% min |
| E Upper story | 20% min |
| F Blank wall area | 30' max |
| Story Height | |
| G Ground floor elevation | 0' min/2' max |
| H Ground story | 12' min |
| I Upper story | 9' min |
| Pedestrian Access | |
| J Entrance facing street | Required |
| K Entrance spacing along street | 75' max |
| Building Elements | |
| | <u>Sec. 5.1.4</u> |
| Awning/canopy | ◇ |
| Balcony | ◇ |
| Forecourt | -- |
| Gallery | ◇ |
| Porch | -- |
| Stoop | ◇ |

SEC. 2.3.3. MARINE CREEK

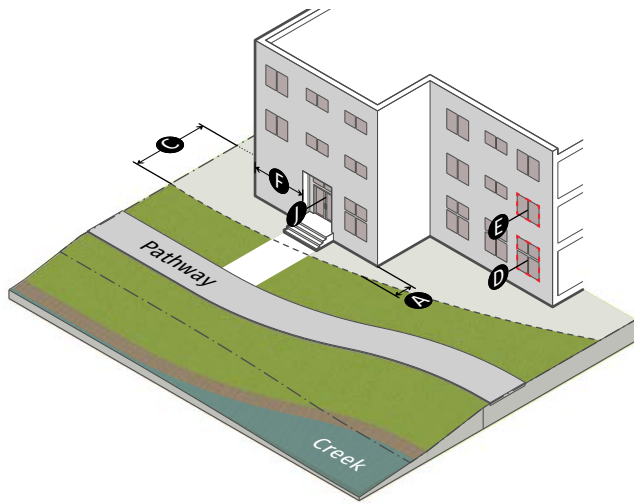

| Setbacks | |
|---|---|
| A | Front (measured from the Marine Creek Floodway and Beautification Easement Line) 0' min |
| B | % of building facade in build-to zone n/a |
| C | Parking setback 30' min |
| Transparency | |
| D | Ground story 20% min |
| E | Upper story 20% min |
| F | Blank wall area 50' max |
| Story Height | |
| G | Ground floor elevation n/a |
| H | Ground story n/a |
| I | Upper story n/a |
| Pedestrian Access | |
| J | Entrance facing Creek Required |
| K | Entrance spacing along Creek n/a |
| Building Elements Sec. 5.1.4 | |
| Awning/canopy | ◇ |
| Balcony | ◇ |
| Forecourt | ◇ |
| Gallery | ◇ |
| Porch | ◇ |
| Stoop | ◇ |

SEC. 2.3.4. OPEN SPACE

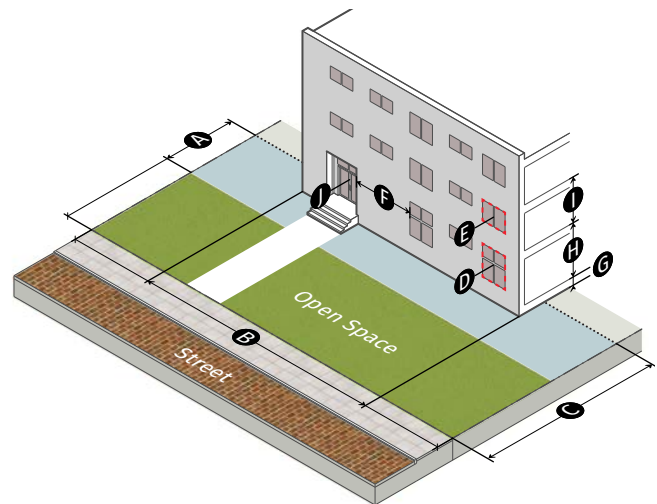

| Setbacks | |
|---|---|
| A | Build-to zone 100' min/120' max |
| B | % of building facade in build-to zone 60% min |
| C | Parking setback 120' min |
| Transparency | |
| D | Ground story 20% min |
| E | Upper story 20% min |
| F | Blank wall area 50' max (ground story only) |
| Story Height | |
| G | Ground floor elevation 2' min/4' max |
| H | Ground story 12' min |
| I | Upper story 9' min |
| Pedestrian Access | |
| J | Entrance facing open space Required |
| K | Entrance spacing along open space n/a |
| Building Elements Sec. 5.1.4 | |
| Awning/canopy | ◇ |
| Balcony | ◇ |
| Forecourt | -- |
| Gallery | ◇ |
| Porch | ◇ |
| Stoop | ◇ |

SEC. 2.3.5. PATHWAY

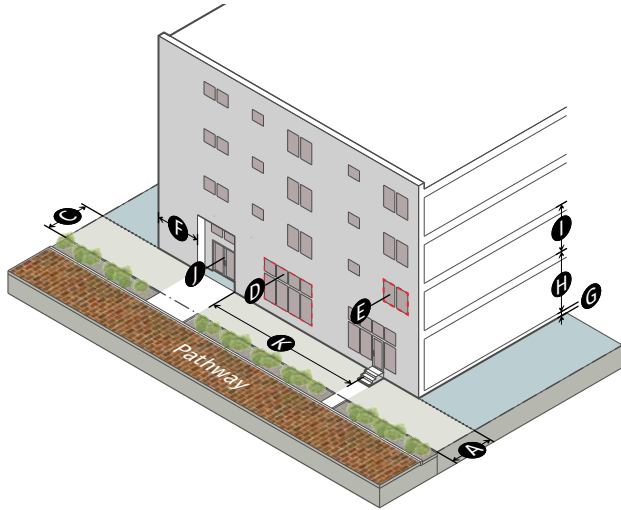

| Setbacks | |
|--|-------------------|
| A Front | 5' min |
| B % of building facade in build-to zone | n/a |
| C Parking setback | 5' min |
| Transparency | |
| D Ground story | 50% min |
| E Upper story | 20% min |
| F Blank wall area | 30' max |
| Story Height | |
| G Ground floor elevation | 0' min/2' max |
| H Ground story | 12' min |
| I Upper story | 9' min |
| Pedestrian Access | |
| J Entrance facing street | Required |
| K Entrance spacing along pathway | 100' max |
| Building Elements | |
| | <u>Sec. 5.1.4</u> |
| Awning/canopy | ◇ |
| Balcony | ◇ |
| Forecourt | ◇ |
| Gallery | ◇ |
| Porch | -- |
| Stoop | ◇ |

SEC. 2.3.6. HISTORIC SHOPFRONT

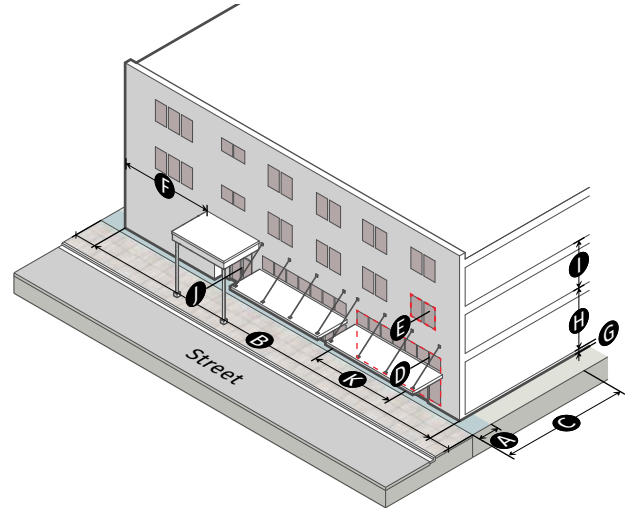

| Setbacks | |
|--|-------------------|
| A Build-to zone | 5' max |
| B % of building facade in build-to zone | 90% min |
| C Parking setback | 30' min |
| Transparency | |
| D Ground story | 70% min |
| E Upper story | 20% min |
| F Blank wall area | 20' max |
| Story Height | |
| G Ground floor elevation | 0' min/2' max |
| H Ground story | 14' min |
| I Upper story | 9' min |
| Pedestrian Access | |
| J Entrance facing street | Required |
| K Entrance spacing along street | 50' max |
| Building Elements | |
| | <u>Sec. 5.1.4</u> |
| Awning/canopy* | ◇ |
| Balcony | ◇ |
| Forecourt | -- |
| Gallery* | ◇ |
| Porch | -- |
| Stoop | ◇ |

*Awning/canopy or gallery required

SEC. 2.3.7. ACTIVE ALLEY

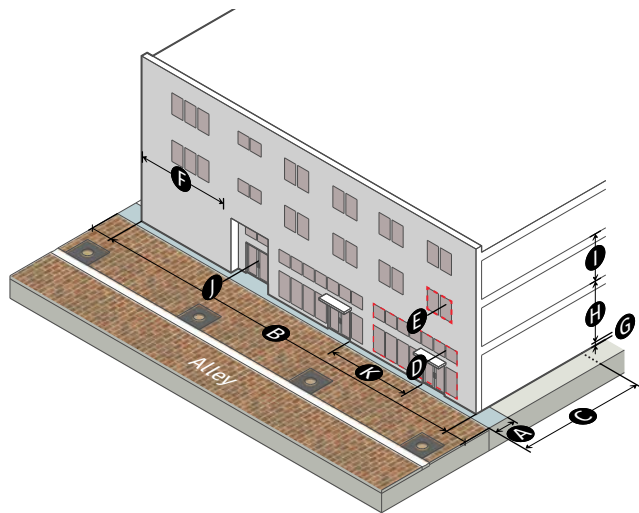

| Setbacks | |
|--|-------------------|
| A Build-to zone | 5' max |
| B % of building facade in build-to zone | 90% min |
| C Parking setback | 30' min |
| Transparency | |
| D Ground story | 70% min |
| E Upper story | 20% min |
| F Blank wall area | 20' max |
| Story Height | |
| G Ground floor elevation | 0' min/2' max |
| H Ground story | 14' min |
| I Upper story | 9' min |
| Pedestrian Access | |
| J Entrance facing alley | Required |
| K Entrance spacing along alley | 50' max |
| Building Elements | |
| | <u>Sec. 5.1.4</u> |
| Awning/canopy | ◇ |
| Balcony | ◇ |
| Forecourt | -- |
| Gallery | ◇ |
| Porch | -- |
| Stoop | ◇ |

SEC. 2.3.8. PLAZA

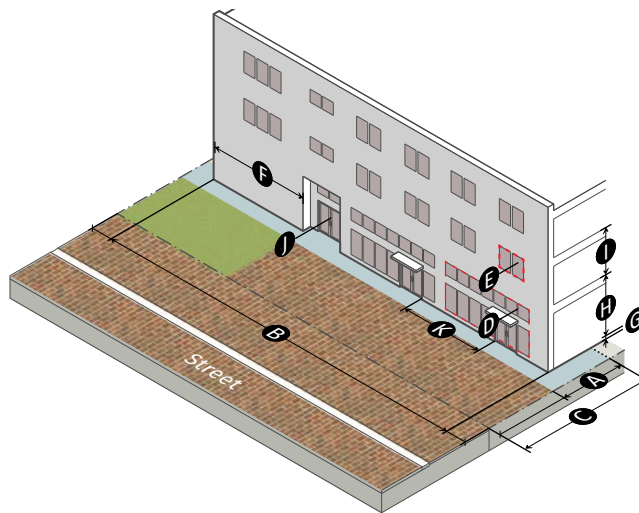

| Setbacks | |
|--|-------------------|
| A Build-to zone | 50' min/120' max |
| B % of building facade in build-to zone | 70% min |
| C Parking setback | 120' min |
| Transparency | |
| D Ground story | 60% min |
| E Upper story | 20% min |
| F Blank wall area | 40' max |
| Story Height | |
| G Ground floor elevation | 0' min/2' max |
| H Ground story | 14' min |
| I Upper story | 9' min |
| Pedestrian Access | |
| J Entrance facing plaza | Required |
| K Entrance spacing along plaza | 100' max |
| Building Elements | |
| | <u>Sec. 5.1.4</u> |
| Awning/canopy | ◇ |
| Balcony | ◇ |
| Forecourt | -- |
| Gallery | ◇ |
| Porch | -- |
| Stoop | ◇ |

SEC. 2.3.9. HERITAGE TREE LAWN

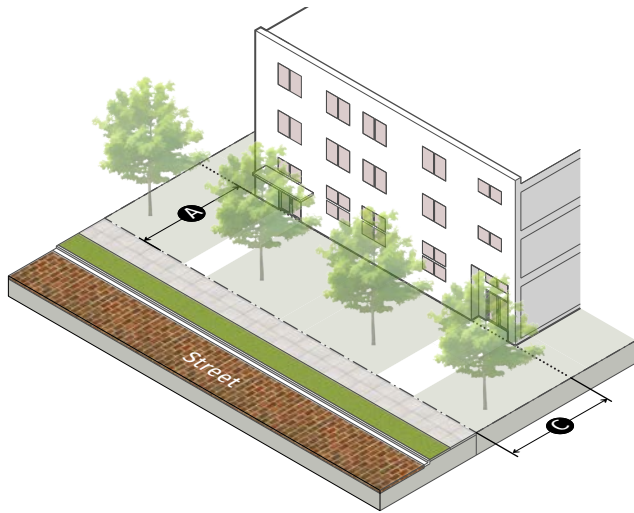

| Setbacks | |
|--|-------------------|
| A Front (min) | 30' min |
| B % of building facade in build-to zone | n/a |
| C Parking setback | 30' min |
| Transparency | |
| D Ground story | n/a |
| E Upper story | n/a |
| F Blank wall area | n/a |
| Story Height | |
| G Ground floor elevation | n/a |
| H Ground story | n/a |
| I Upper story | n/a |
| Pedestrian Access | |
| J Entrance facing street | n/a |
| K Entrance spacing along street | n/a |
| Building Elements | |
| | <u>Sec. 5.1.4</u> |
| Awning/canopy | -- |
| Balcony | -- |
| Forecourt | -- |
| Gallery | -- |
| Porch | -- |
| Stoop | -- |

Div. 2.4. Historic Design Guidelines

This Division presents design guidelines for the Historic District. It includes a listing of key historic preservation principles for the District (Sec. 2.4.2), standards and guidelines for Contributing Buildings (Sec. 2.4.3), standards and guidelines for Non-Contributing Buildings and New Construction (Sec. 2.4.4) and standards and guidelines for Site Design (Sec. 2.4.5). Photographs and drawings included that illustrate how design principles and guidelines should be exemplified in specific development projects.

SEC. 2.4.1. STATEMENT OF SIGNIFICANCE

SUMMARY OF SIGNIFICANCE

The Fort Worth Stockyards Local Historic District is one of the most significant sites in Texas representing the importance of the cattle and livestock industry to the state and is significant under Criteria 1, 2, 3, 4, 5, 6, 8, 9, and 10 of Chapter 4, Article 4 of the City of Fort Worth Zoning Ordinance.

The establishment of the Fort Worth Stockyards coincides with the beginnings of the cattle and livestock industries in the southwest (Criteria 1, 6, 9). After the founding of the Armour and Swift packing plants at this location in 1902, the new activity assured Fort Worth's ascendancy as the major livestock market of the southwest. The Stockyards also provided the major impetus for the growth and early development of Fort Worth. As the city's first industry, the stockyards and later packing plants transformed Fort Worth from a small frontier community into a major Texas metropolis.

DESCRIPTION OF THE HISTORIC PLACE

The Fort Worth Stockyards Local Historic District is located in Tarrant County in northeast Texas. It is characterized by commercial, agricultural, industrial, and landmark buildings and features, as well as a unique circulatory framework, constructed from the late 20th century to the mid-21st century (Criteria 2, 3, 4, 5, 8).

The district is located north of downtown Fort Worth and is centered on the major axis created by the intersection of Main Street and Exchange Avenue. The boundaries of the district run north to the intersection of Main St. and 26th St.; run east along property lines to encompass some of the original cattle pens and livestock framework; turn south down



The Stockyards Coliseum

Packers Avenue and Niles City Boulevard; then west along the southern portion of the Horse & Mule Barns property lines to Main Street; and finally running north and west to encompass the commercial structures that border Main St., Exchange Ave., NW 24th Street, and NW 25th Street. The district is surrounded by non-historic mixed-use development to the north; historic residential neighborhoods to the west; historic mixed-use, residential, and industrial to the South; and non-historic industrial to the east.

Today, the Stockyards Local Historic District contains 70 buildings, 54 of which are contributing, and a collection of character-defining settings from the period of significance of the district (1902 to 1962).¹

DISTINCT CHARACTER

Although only a small portion of the original Armour & Swift Meatpacking Plants remains today, the buildings that remain reflect the traditional industrial style, consisting of primarily brick structures with heights that vary from 2 to 9 stories. Lower scale buildings that served as a transition to the commercial core of the district were located on the western edge of the industrial area, while the height and intensity increased to the east.

Landmark buildings within the district include the Exchange and Coliseum, generally built in the Mission Revival style from 1902-1925, and set back from the street so as to delineate their importance from their more agricultural and industrial neighbors (Criteria 2, 4). However, there are some landmark buildings such as the Horse & Mule Barns that are reflect the Mission Revival style but adhere directly to the street, much in the same way that the commercial buildings do.

The commercial buildings within Fort Worth Stockyards Local Historic District, constructed primarily between 1902 and 1925, consist predominately of 1 and 2-story brick buildings that share party walls, maximize lot frontage, and have no street setback. Several of these buildings were designed by notable local architects and constructed by a local master builder, such as the Stockyards Hotel that was designed by E. Stanley Field and Wiley G. Clarkson (Criteria 3, 8). The unique circulatory framework consists of a gridded network of streets, walkways, and ramps that were designed to efficiently move animals, vehicles, and people through the district (Criteria 5). It is composed of a hierarchy of runs that provided ways to move cattle to and from the pens, through scale houses, to meat packing plants and, once processed, onto trains. The arrangement of the cattle pens determined the circulation routes for much of the livestock. Sitting north of Exchange Avenue, just to the east of the Exchange Building,



This example of a recently rehabilitated building shows a contemporary entry to the historic facade.



¹ The Fort Worth Stockyards Historic District was listed on the National Register on June 29th, 1976 (Criteria 10). This district boundary is much larger than the Local Historic District boundary. The smaller Local Historic District boundary removes properties from within the original National Register boundaries that lost integrity or have been demolished from 1976 to 2017.

elevated and suppressed walkways (runs) from the pens provided direct routes to ramps that led into the packing plants. Vestiges of this circulation system survive, including part of the subway, some ramps and the paved walkways once were framed with cattle pens. These remnants are key features unique to the Stockyards Local Historic District that cannot be found anywhere else in the city.

CHARACTER DEFINING FEATURES

There are numerous character defining features that characterize the Stockyards today. The following list is not intended to be exhaustive.

Livestock

- » The character of livestock odors
- » Bovine sounds
- » Sightings of livestock (esp. the longhorn cattle)

Livestock Structures and Circulation

- » Design, scale, location, materials and construction of rectilinear livestock pens and fencing
- » Roofed sheep and pig pens with clerestory windows
- » Cattle runway ramps and sheep/pig “subway”
- » Remnants of scale houses and holding pens for livestock
- » Raised-brick thoroughfares, brick paving pen floors and walkways
- » Raised walks throughout the pens

Built Form

- » Traditional/Early 20th Century commercial character and scale of N. Main Street and Exchange Avenue
- » Scale of Exchange Avenue and N. Main Street, consisting of 1 and 2 story brick buildings

Armour & Swift Site

- » Armour & Swift stairs
- » Topographic character defining the Armour & Swift site
- » Remains of the Armour & Swift meatpacking plants
- » Retaining walls from the period of significance
- » Historic tree land along west edge of Packers Street

Marine Creek

- » Marine Creek, including its landform, meandering contours of creek bank, waterway, and the composite setting
- » informal tree-lined creek edge
- » “Sawtooth” edge of built form along Marine Creek
- » Masonry arch structure that supports Exchange Avenue and the setting created by landform and flanking built form

Traditional Use and Development

- » Incremental development

- » Built form urban grain
- » Continued use by the livestock and agricultural industry

Views and Vistas

- » Views C1-C7 identified in View Opportunities of the Form-Based Code & Design Guidelines
- » The iconic image produced by curvilinear parapets and octagonal cupolas of the Stock Exchange Building against the sky
- » The iconic image produced by the two-story towers that mark the entrance to the Horse & Mule Barns against the sky
- » Conjunctive views of the Coliseum and the Stock Exchange Building
- » Livestock runway vista terminating at the Coliseum and Stock Exchange Building

Settings, Forecourts and Backdrops

- » Setting and forecourt of the Stock Exchange Building
- » Marine Creek backdrop to the Horse & Mule Barns
- » Traditional streetscape backdrop to the Fort Worth Stockyards over-street sign

Circulation

- » Hierarchy of Exchange Avenue and N. Main Street as character-defining pedestrian streets
- » Packers Street, traditionally used for vehicular movement
- » Remnant rail lines/circulation corridors

SEC. 2.4.2. HISTORIC PRESERVATION PRINCIPLES



Historic preservation is well established in the Historic District where many individual property owners have worked to preserve its cultural resources. While community goals and economic conditions may change over time, preserving the heritage of the Stockyards remains a primary goal of the community.

This section presents an overview of historic preservation principles that apply to the Historic District. It also provides guidance on how to plan a preservation project, determine architectural styles and choose the appropriate treatment for a historic property.

The material in this section will be applied when determining the appropriateness of changes to historic properties in the Historic District.

A. Planning a Preservation Project

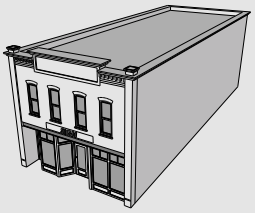
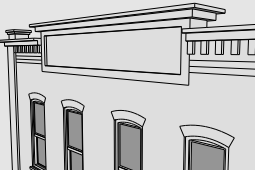
When planning a preservation project, it is important to first determine the historic significance of the property and the degree to which it retains its integrity as a historic property. Next, a specific approach to the overall treatment of the property should be established. This may include preserving the building in its current state, while making appropriate repairs, or incorporating new, compatible changes. It is then important to determine how surviving historic features will be treated. This may include preserving those features that remain intact, repairing those that are deteriorated and replacing others.

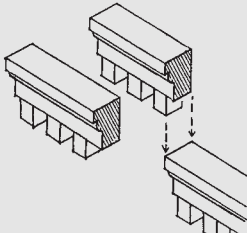
| STEPS FOR PLANNING A PRESERVATION PROJECT | | Seven Aspects of Integrity |
|--|---|---|
| Step 1: Why is the building significant? | | <p>In evaluating the historic significance of features that survive in the Historic District, there are 7 “aspects of integrity” that should be applied. These are based on those used in the National Register of Historic Places. The 7 aspects are:</p> <p>Location Location is the place where the historic property was constructed or the place where the historic event took place.</p> <p>Design Design is the composition of elements that constitute the form, plan, space, structure, and style of a property.</p> <p>Setting Setting is the physical environment of a historic property that illustrates the character of the place.</p> <p>Materials Materials are the physical elements combined in a particular pattern or configuration to form a historic property.</p> <p>Workmanship Workmanship is the physical evidence of the crafts of a particular culture or people during any given period of history.</p> <p>Feeling Feeling is the quality that a historic property has in evoking the aesthetic or historic sense of a past period of time.</p> <p>Association Association is the direct link between a property and the event or person for which the property is significant.</p> |
|  | <p>Building significance. Understanding the history of a building is important to any preservation project. Where it is available, survey information should be consulted to help identify the building’s age, style and its key character-defining features. This will help determine to what degree the property should be preserved as it is, or where there may be opportunities for compatible alterations to occur.</p> | |
| Step 2: What is the condition of the building and its KEY character-defining features? | | |
|  | <p>Integrity. The condition of a building and its features contribute to the overall significance of the building. A building with historic integrity has a sufficient percentage of character-defining features, and key features remain intact. These key elements allow a building to be recognized as a product of its time.</p> | |
| Step 3: What is the desired project? | | |
|  | <p>Program requirements. Are any functional improvements needed for the desired building use? Or is preservation of character-defining features the objective? If restoring features is the focus, then other alternative design approaches may not be necessary, but if some functional improvements are needed, then compatible alterations and/or additions may be the approach.</p> | |
| Step 4: What is the Strategy? | | |
|  | <p>Strategy. A preservation project may include a range of activities, such as maintenance of existing features, repair of deteriorated materials, the replacement of missing features and construction of a new addition. While the term “preservation” is used broadly to mean keeping a historic property’s character-defining features, it is also used in a more specific, technical form to mean keeping a resource in good condition. This, and other related terms, are important to understand because they are all used when planning work on a historic property.</p> | |

B. Historic Architectural Styles

The following architectural styles have been identified by the Texas Historical Commission through historic surveys that were completed for the existing historic buildings in the Historic District:

| Key Character-Defining Features |
|--|
| Roofs <ul style="list-style-type: none"> • Flat with parapets • Shed overhangs with modillions |
| Heights <ul style="list-style-type: none"> • One to two-stories |
| Building Materials <ul style="list-style-type: none"> • Stucco or plaster • Clay roof tiles |
| Detailing <ul style="list-style-type: none"> • Curvilinear-shaped gable • Arcades • String courses • Round arched windows and entries |
| Other Features <ul style="list-style-type: none"> • Cast-iron balconies • Arched transom lights (usually covered) • Shed roof porch/canopy with plain wood post supports |

MISSION REVIVAL (ca. 1800-1930)

Easily recognized by the curvilinear-shaped gable wall or the low parapet wall rising above the roofline, the Mission Revival style is characterized by smooth stuccoed or plastered walls with modest ornamentation. The roof is usually tile, and semicircular arched openings form windows, entries and arcades. The curvilinear-shaped roofline distinguishes the Mission from the similar Mediterranean style.



Mission Revival

Key Character-Defining Features**Roofs**

- Flat roof with parapet

Heights

- One to four-stories

Building Materials

- Brick
- Simple to ornate pilasters

Detailing

- Storefront system
- Punched upper story window openings typically double-hung with ornate surrounds
- Ornate detailing at cornice

Other Features

- Primary entry
- Awning or canopy

EARLY 20TH CENTURY – VERNACULAR COMMERCIAL STOREFRONT (ca. 1900-1940)

Early twentieth century commercial buildings are generally one to four-stories, with flat or slightly pitched roofs. Often constructed of red, blond or light colored brick, these buildings have very little ornamentation other than some decorative brick work along the cornice or parapet. In some cases, 20th century commercial buildings exhibit some detailing from 19th century commercial buildings.



Early 20th Century Commercial Storefront

ART MODERNE (ca. 1920-1940)

This modernistic style received its first major impetus in 1922 when the Chicago Tribune held a world-wide competition for a headquarters building in Chicago. Although first prize went to a Gothic design, the second prize went to an Art Deco design by a young Finnish architect, Eliel Saarinen. His design was widely publicized and the style quickly became the latest architectural fashion.

This late 19th – Early 20th Century Vernacular style building received Art Moderne facade treatments over time. Buildings of this style exhibit smooth facades with decorative horizontal bands, steel plate glass storefronts and horizontal canopies that may have been altered from their original form.



Art Moderne

Key Character-Defining Features

Roofs

- Flat roof
- No eaves

Heights

- One or multiple stories

Building Materials

- Stucco
- Brick
- Steel

Detailing

- Smooth wall surface
- Horizontal banding
- Asymmetrical facade

Other Features

- Glass block
- Window bands

Key Character-Defining Features

Roofs

- Flat with parapet

Heights

- Two to three-stories

Building Materials

- Masonry
- Brick

Detailing

- Stepped front
- Broken cornice line
- Geometric forms

Other Features

- Symmetrical
- Raised foundations
- Architectural sculptures
- Polychromatic materials
- Vertical emphasis

ART DECO (ca. 1930-1940S)

Art Deco is characterized by an angular, linear composition, stepped or set-back facade and polychromatic materials. Geometric forms are the most common stylistic expressions. Stepped cornice lines, low relief geometrical designs, spandrel panels, architectural sculptures, polychromatic materials and a vertical emphasis are also characteristic of this style. Decorative facade elements include chevrons, zigzags and stylized floral and geometric motifs.



Art Deco

Key Character-Defining Features

Roofs

- Flat

Heights

- Multiple stories

Building Materials

- Brick
- Concrete
- Local materials

Detailing

- Smooth untextured surfaces
- Cantilevers
- Bands of windows
- Casement windows
- Flat roof

Other Features

- Solid planes
- Simple building forms
- Lack of ornamentation

INTERNATIONAL (ca. 1930-1950S)

The International style is known for its smooth, unadorned surfaces, flat roofs, bands of flush windows and asymmetrical composition. Commercial and industrial buildings designed in this style are built with strong horizontal elements usually alternating between bands of windows and solid planes. Instead of using color, this style emphasizes light and shadow.



International

C. Choosing a Strategy

When planning work on a historic property, the option that requires the least intervention is always preferred to best maintain its integrity. The options below are listed in order of preference, followed by information on other work categories that are not generally appropriate for historic structures.



Restoration often involves individual building features such as this restored cornice.



Remodeling the storefront of a historic building (Fort Collins, CO) to accommodate an auto repair shop is inappropriate. Storefronts were removed to make way for a garage. (Compare with the image below.)



The removal of the inappropriate garage door and the rehabilitation of this commercial building successfully returns the property to the state that preserves the building's historic integrity.

APPROPRIATE TREATMENTS

The following is a list of appropriate treatments for historic properties in the Historic District.

Preservation as treatment for a historic property, is the act or process of applying measures to sustain the existing form, integrity and material of a building. Some work focuses on keeping a property in good working condition by repairing features as soon as deterioration becomes apparent, using procedures that retain the original character and finish of the features. Property owners are strongly encouraged to maintain properties in good condition.

Restoration is the act or process of accurately depicting the form, features and character of a property as it appeared in a particular time period. It may require the removal of features from outside the period of significance.

Rehabilitation is the process of returning a property to a state that makes a contemporary use possible while still preserving those portions or features of the property which are significant to its historical, architectural and cultural values. Rehabilitation may include a change in use of the building or constructing an addition to the original structure. This term is the broadest of the appropriate treatments and is often used in the guidelines with the understanding that it may also involve other appropriate treatments.

Reconstruction is the act or process of depicting, by means of new construction, the form, features and detailing of a non-surviving site, landscape, building, structure or object for the purpose of replicating its appearance at a specific time and in its historic location.

Combining Treatments. While these terms are used interchangeably in informal conversation, the more precise meanings are used when describing the overall strategy for a historic property.

Preferred Sequence of Work

The following treatment options appear in order of preference. When making a selection, follow the sequence outlined below.

Step #1: Preserve

If a historic feature is intact and in good condition, preserve it with regular maintenance to sustain the integrity of the structure.



Step #2: Repair

If a historic feature is deteriorated or damaged, repair it to its original condition.



Step #3: Replace

If it is not feasible to repair a historic feature, then replace it in kind (i.e., materials, detail and finish). Replace only that portion which is beyond repair.



Step #4: Reconstruct

If all or part of a historic feature is missing, reconstruct it from appropriate evidence, such as historical photographs, or features on similar adjacent properties.



Step #5: Add Compatible Features

If a new feature (one that did not exist previously) or an addition is necessary, its design should minimize the impact on a historic structure. It is also important to distinguish new features on a historic structure from original historic elements, and to avoid adding features to primary building facades.

For many improvement projects in the Historic District, a rehabilitation approach will be the overall strategy. However, specific building components may warrant different treatment methods. For example, a surviving cornice may be preserved, a storefront base that has been altered may be restored, and a missing kickplate below a display window may be reconstructed.

PREFERRED SEQUENCE OF WORK

When planning work on a historic property, those actions that require the least intervention are always preferred. The options described to the left are listed in order of preference. Options that are not generally appropriate for historic structures are described below.

INAPPROPRIATE ACTIONS

The following are not appropriate for historically significant properties in the Historic District.

Remodeling is the process of changing the historic design of a building. The appearance is altered by removing original details and by adding new features that are out of character with the original design. Remodeling of a historic structure is inappropriate.

Deconstruction is the process of dismantling a building such that the individual material components and architectural details remain intact. This may be employed when a building is relocated or when the materials are to be reused in other building projects. Deconstruction may be a "last resort" alternative to conventional demolition in certain circumstances.



Many historic features, including the window openings and storefront, have been substantially altered on this property.



This building retains a high degree of historic integrity and the historic condition is fully intact. Recent restoration work is in keeping with the character.

D. Setting Priorities for Preservation

| Location A: Highly sensitive | Location B: Less sensitive | Location C: Least sensitive |
|--|---|--|
| <ul style="list-style-type: none"> • Preservation of features in place is the priority. • This is especially important at the street level and in locations where the feature is highly visible. | <ul style="list-style-type: none"> • Preservation of features in place also is a priority but a compatible alteration may be considered. | <ul style="list-style-type: none"> • Preservation of features is recommended but more flexibility in making alterations may be available. |

CONSIDERING A VERNACULAR COMMERCIAL BUILDING:

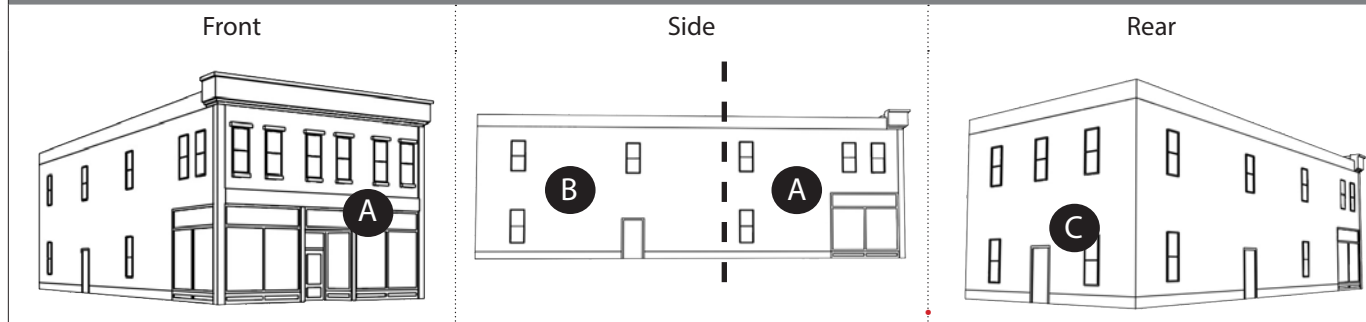

For many of the “contributing” commercial storefronts on historic resources in the Historic District, the front wall is where many key, character-defining features will be located. Alterations are rarely appropriate. Many side walls are also important to preserve, particularly where they are highly visible from the street or other public way. By contrast, portions of a side wall that are not as visible may be less sensitive to change. A rear wall is usually the least sensitive, and alteration may occur more easily without causing negative effects to the historic significance of the property. This concept of evaluating the different faces of a building to locate the appropriate places for alterations is illustrated in the sketches below.

CONSIDERING A DISTINCTIVE LANDMARK BUILDING:

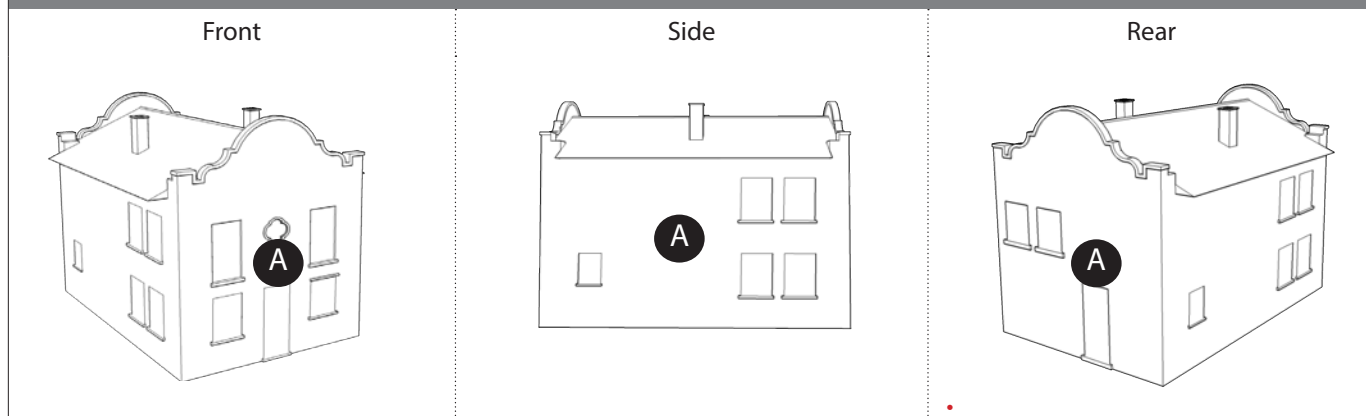

Several historic resources in the district are of “landmark” quality, in terms of their significance. The Coliseum, Stock Exchange building, Stockyards Station and the Horse and Mule Barns are noteworthy examples. Historically, these properties have been experienced “in the round,” with all sides conveying functional and design aspects that contribute to their historic significance. Alterations to these buildings must be considered carefully for that reason. While some modest alterations may be considered, they should occur in ways that minimize impacts on key features in all locations.

PLANNING WORK ON A HISTORIC COMMERCIAL BUILDING

What is the best approach for work on a historic commercial building that has already experienced some alterations? A range of options may be available depending upon certain facts. First, determine the historic character.

Intact Historic Structure

- A** Pilasters with brick cap and base
- B** Ornamental brick cornice
- C** Upper story windows, double hung with brick arches
- D** Sign panel above molding
- E** Lintel

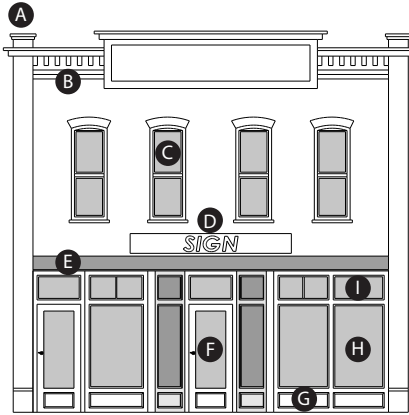

- F** Wood panel door
- G** Wood paneled bulkhead
- H** Display Window
- I** Transom Window

Next, assess the existing conditions:

Altered Historic Structure

- A** Pilasters removed
- B** Ornamental cornice removed
- C** Upper story windows intact
- D** Sign obscures window details
- E** Molding covered

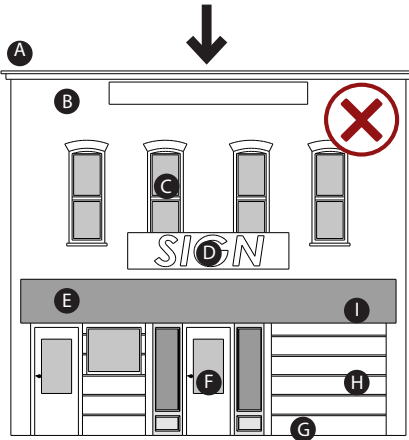

- F** Original door missing
- G** Bulkhead missing
- H** Display windows altered
- I** Transom window covered



Historic Reconstruction

- Surviving features preserved and restored
- Missing cornice and pilasters reconstructed
- Storefront elements reconstructed



Contemporary Rehabilitation

- New cornice reflects the form of the original
- Upper windows preserved
- Contemporary finished metal storefront in scale with original
- Canopy installed



Simplified Rehabilitation

- Simplified interpretation of the cornice
- Upper windows preserved
- Contemporary finished metal storefront in scale with original

SEC. 2.4.3. STANDARDS AND GUIDELINES FOR CONTRIBUTING BUILDINGS

This section provides design guidelines for the treatment of historic properties (contributors and landmarks) in the Historic District. It focuses on the preservation of key character-defining features of each individual contributing property as well as preservation of the district as a whole. The design guidelines in this section do not apply to new construction or to alterations of non-contributing properties. These topics are discussed [Sec. 2.4.4](#).

A. Character-Defining Features

Character-defining features help convey the historic and architectural significance of historic properties and vary by architectural style. Some character-defining features are distinctive details. The form, height and massing also are key character-defining features. The design standards and guidelines address treatment of these features. The method of preservation that requires the least intervention is always preferred.

1. Maintain key character-defining features.
 - a. Key character-defining features include:
 - i. Ornamentation and architectural details
 - ii. Building materials
 - iii. Windows and doors
 - iv. Cornices and eaves
 - v. Parapets
 - b. Retain and treat exterior features and examples of skilled craftsmanship with sensitivity.
 - c. Employ preventive maintenance measures such as rust removal, caulking and repainting to keep features in good condition.
2. Repair, rather than replace, a key character-defining feature if it is damaged.
 - a. Do not remove or alter distinctive character-defining features that are in good condition or that can be repaired.
 - b. Document the location of a character-defining feature that must be removed in order to be repaired so it may be repositioned accurately.
 - c. Patch, piece-in, splice, consolidate or otherwise upgrade deteriorated features using recognized preservation methods.
 - d. Minimize damage to historic character-defining features when repairs are necessary.
 - e. Protect other character-defining features that are adjacent to the area being worked on.
3. Reconstruct a key character-defining feature accurately if it cannot be repaired.

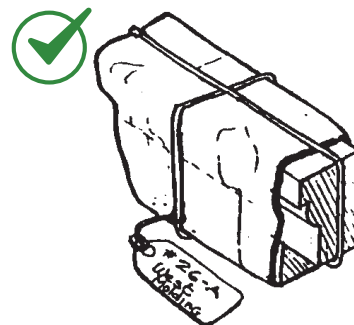

Document the location of a historic feature that must be removed and repaired so it may be repositioned accurately.

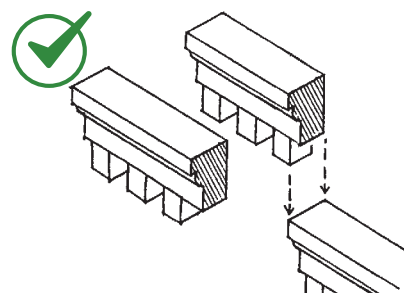

Patch, piece-in, splice, consolidate or otherwise upgrade deteriorated features using recognized preservation methods.



Simplicity in building form or material can be a key character-defining feature.



Retain and treat exterior features and examples of skilled craftsmanship with sensitivity.

- a. Use a design that is substantiated by physical or pictorial evidence to avoid creating a misrepresentation of the building's history.
- b. Use the same kind of material as the original to the extent feasible. An alternative material may be considered if it:
 - i. Has proven durability
 - ii. Has a size, shape, texture and finish that conveys the visual appearance of the historic feature
 - iii. Is located in a place that is remote from view or direct physical contact
 - iv. Do not add details that were not part of the historic structure. For example, decorative millwork should not be added to a building if it was not a historic feature, as it would convey a false history.

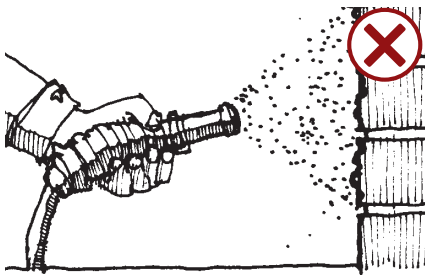

Do not use harsh cleaning methods, which can inhibit the function and/or appearance of the historic material, (such as sandblasting, which can damage its protective coating).



Protect and maintain historic stucco.

B. Materials and Finishes

Historic materials should be preserved in place. If the material is damaged, limited replacement to match the original should be employed. Historic building materials should never be covered or subjected to harsh cleaning treatments. Preserving historic building materials and limiting replacement to only pieces which are deteriorated beyond repair also reduces the demand for, and environmental impacts from, the production of new materials and therefore supports sustainability objectives.



SEE SEC. 5.2.4 FOR BUILDING MATERIAL STANDARDS

1. Maintain historic building materials.
 - a. Preserve historic building materials from deterioration.
 - b. Maintain historic material finishes, including painted signs.
 - c. Do not remove historic materials that are in good condition.
 - d. Use a low pressure water wash if cleaning is permitted. Chemical cleaning may be considered if a test patch does not have a negative effect on the historic fabric (the test patch should be reviewed by the City's preservation department).
 - e. Do not use abrasive cleaning methods, which can inhibit the function and/or appearance of the historic material, (such as sandblasting, which can damage protective coatings and have an adverse effect).

2. Preserve the visibility of historic materials.
 - a. Consider removing later covering materials that have not achieved historic significance.
 - b. Once a non-historic material is removed, repair the historic, underlying material.
 - c. Do not cover or obscure historic building materials.
 - d. Do not add another layer of new material if a property already has a non-historic building material covering the historic material.
3. Repair historic building materials when needed.
 - a. Repair deteriorated building materials by patching, piecing-in, consolidating, or otherwise reinforcing the material.
 - b. Replace only those portions that are deteriorated and beyond reasonable repair.
4. Replace historic building materials in kind if repair is not feasible.
 - a. Use the same material as the historic one to replace damaged building materials.
 - b. Replace only the amount of material that is beyond repair.
 - c. Use only replacement materials that are similar in scale, finish and character to the historic material.
 - d. Use only replacement materials with proven durability.
 - e. Do not replace building materials with alternative or imitation materials unless no other option is available.



Removal of covering material exposes historic building fabric.

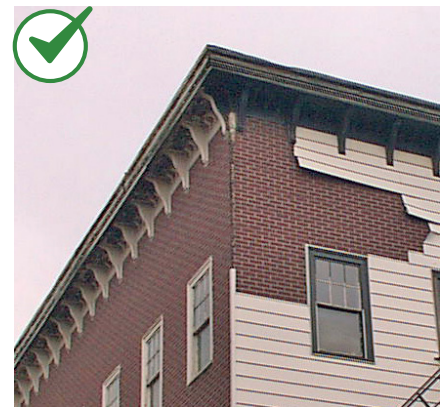

Consider removing later covering materials that have not achieved historic significance.



Before: Historic material covered



After: Historic material revealed



Preserve historic materials.

PRESERVING HISTORIC MATERIALS:

Primary historic building materials used in the Stockyards include masonry (brick, mortar, stone, concrete), stucco, wood and metal. Such materials should be preserved whenever possible. Appropriate treatments to protect specific materials from deterioration include:

Masonry

- Maintain the natural uncovered water-protective layer (patina).
- Do not paint (this can seal in moisture, which may cause extensive damage over time).
- Repoint deteriorated masonry mortar joints with mortar that matches the strength, composition, color and texture of the original. Note, some new mortars can damage original masonry (have mortar professionally tested to determine composition). Also, duplicate the mortar joints in width and profile.
- Maintain masonry caps to insure proper drainage.

Stucco

- Keep surfaces clean with a low-pressure water wash.
- Apply stucco in suitable weather conditions.
- Use compatible stucco for repairs. Consult a historic masonry specialist to determine appropriate product type and color.

Wood

- Maintain paint and other protective coatings to retard deterioration and ultraviolet damage.
- Provide proper drainage and ventilation.
- Use compatible paints. Some latex paints will not bond well to earlier oil-based paints without a primer coat.

Metal

- Maintain protective coatings, such as paint, on exposed metals.
- Provide proper drainage.

All Materials

- Epoxies and resins may be considered for wood repair and special masonry repair components also may be used.
- Use a low pressure water wash if cleaning is appropriate. Chemical cleaning may be considered if a test patch is first reviewed and negative effects are not found.
- Do not use harsh cleaning methods, such as sandblasting, which can damage historic materials, changing their appearance.

For More Information:

The following National Park Service preservation briefs at www.nps.gov provide additional information on the treatment of historic materials:

Preservation Brief 1: Assessing Cleaning and Water-Repellent Treatments for Historic Masonry Buildings

Preservation Brief 2: Repointing Mortar Joints in Historic Masonry Buildings

Preservation Brief 16: The Use of Substitute Materials on Historic Building Exteriors

Preservation Brief 22: The Preservation and Repair of Historic Stucco



Preserve original materials.

Using Non-Historic Materials on a Historic Structure:

The design guidelines sometimes refer to the use of non-original materials when describing the appropriate treatment of historic building features and components such as moldings, windows, siding and other architectural details.

A non-original material is one which is different from that used originally for a specific application. Such materials may also be called “substitute”, “replacement”, “synthetic” or “imitation” materials, and can include:

- Vinyl siding or fencing
- PVC decking or fencing
- Aluminum siding
- Hardie Plank siding
- Cementitious fiber siding
- Spray-on coatings
- Synthetic stucco
- Panelized brick
- Other non-original materials



Fiber cement siding

Non-original materials may also include those used to replace historic architectural features such as a resin-cast cornice used in place of a stamped metal cornice. In other cases, an original material may be traditional when used for other applications, but new for the particular detail being considered. Using wood to replace an original stamped-metal cornice is an example.

Non-original materials may be considered by the Historic and Cultural Landmarks Commission on a case-by-case basis as replacement materials or for use on a new addition or new building in a historic district. The City will consider factors including:

Potential Impact on Historic Significance. Removing original material diminishes the integrity of a historic property by reducing the percentage of building fabric that remains from the period of historic significance. Retaining the original material is always preferred. If this is not feasible, non-original materials may be considered. When used, a non-original material should convey the character, including durability, detail and finish, of the original to the greatest extent feasible.

Appearance. A non-original material should have a similar profile, texture and finish as the original material. Some synthetic siding has an exaggerated, rusticated finish that is an inaccurate representation of the original clapboard, and many vinyl products have a sheen that is out of character with that of painted wood and metal. These are inappropriate.

Durability. A non-original material should have proven durability in similar applications. While some new materials are very sturdy, others may degrade quickly and can be difficult to repair.

Location. Up close, it is easier to identify some non-original materials due to differences in texture, finish and feel. Tapping on a hollow plastic column or fence does not convey the same experience as the original. For this reason, locations that are more remote are better.

Cost. Some non-original materials are promoted because their initial costs appear to be less than repairing or replacing the original. When the other qualities of appearance and durability are proven, then the less expensive option may be appropriate. However, long-term, “life cycle” costs should also be weighed. Sometimes, the up-front saving is deceptive.

Environmental Impacts. The potential environmental impacts of non-original materials should also be considered including impacts associated with manufacture, transport, installation and ability to recycle.

Interaction with Historic Building Materials. Some non-original materials may interact negatively with historic materials. For example, some metals may corrode and stain original materials and some window and siding materials may expand and contract with temperature changes in ways.



Fiber cement siding



Repair, rather than replace, frames and sashes.



Preserve and repair historic windows.



Do not reduce a historic opening to accommodate a smaller window.



Preserve historic windows.

C. Windows

Original windows help convey the significance of historic structures, and should be preserved. They can be repaired by re-glazing, patching and splicing elements such as muntins, the frame, sill and casing. Repair and weatherization measures also are often more energy efficient, and less expensive, than replacement. If a historic window cannot be repaired, a new replacement window should be in character with the historic building.

1. Preserve and repair historic windows.
 - a. Preserve historic window features including the frame, sash, muntins, mullions, glazing, sills, heads, jambs, moldings, operation and groupings of windows.
 - b. Repair and maintain windows regularly, including trim, glazing putty and glass panes.
 - c. Repair, rather than replace, frames and sashes.
2. Replace a historic window in-kind if repair is not possible.
 - a. Replace with the same material.
 - b. Match the appearance of the historic window design (i.e., if the historic is double-hung, use a double-hung replacement window).
 - c. Maintain the historic size, shape and number of panes.
 - d. Match the profile of the sash, muntin and its components to the historic window, including the depth of the sash, which may step back to the plane of the glass in several increments.
 - e. Use clear window glazing that conveys the visual appearance of historic glazing (transparent low-e glass is preferred).
 - f. Do not use vinyl and unfinished metals as window replacement materials.
 - g. Do not use metallic or reflective window glazing.

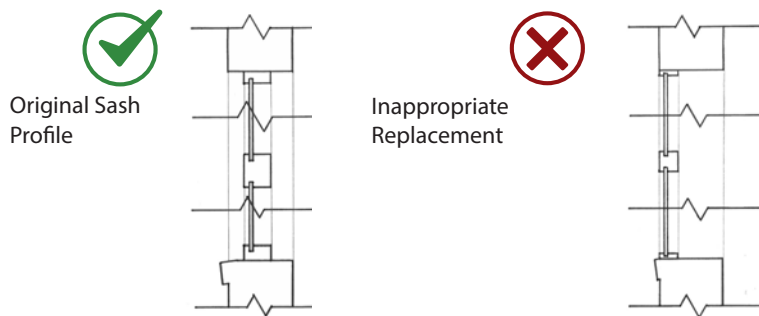

These sketches show a section through two windows; the original and a proposed replacement. The proposed replacement window is inappropriate since it does not match the profile of the original window.

- h. Do not reduce a historic opening to accommodate a smaller window or increase it to accommodate a larger window.
- 3. Use special care when replacing a window in a key character-defining location.
 - a. Give special attention to matching the historic design and materials of windows located on the primary facade.
 - b. Match the historic design and positioning of the window within the opening when replacing a window.
- 4. Restore a historic window opening that has been altered.
 - a. Restore a historic window opening that previously existed.
 - b. Place a new window to fit within the historic opening.
- 5. When necessary, locate and design a new window opening to preserve the overall rhythm and arrangement of windows.
 - a. Locate a new window opening to match the general arrangement of historic windows in a building wall.
 - b. Design a new window opening to match historic window proportions on the same facade.
 - c. The new window should complement the historic windows, but should be designed to be different.



Restore a historic window opening that has been altered.



Give special attention to matching the historic design and materials of windows located on the facade.



Use special care when replacing a window on a primary facade.



Restore a historic window opening that has been altered. For example, this opening has been blocked. Restoring the window is best practice in this situation.

Benefits of Wood Window Retrofits:

Sensitive stewardship of the existing building stock significantly reduces environmental impacts. Re-using a building and its original wood windows preserves the energy and resources invested in its construction, reduces demand on landfill space and eliminates the need for producing new construction materials. Manufacturing of many new building materials uses substantial levels of energy. This can be reduced significantly if historic structures and its wood windows are retained rather than demolished.

Many historic building materials, such as a building's wood windows have long life cycles, which contribute to their sustainability. They were built for longevity in a manner that also allows for repairs. Some replacement features for historic buildings, such as synthetic window materials, advertise they are low in maintenance, inexpensive and durable etc., when in fact they have a significantly shorter life span than historic wood windows, are difficult to repair and are incompatible with historic building materials.

An older window is often falsely accused of being a major source of heat loss, when other parts of a building are typically the major sources. For example, as much as 50% of the energy lost from a house is from air infiltration through the attic, uninsulated walls, and around the windows and door cavities, not through the glass in a window itself. Repairing, weather-stripping and insulating an original window is typically more efficient and much less expensive than new windows, as well as sound preservation practice. Retrofits also extend the life of existing windows, avoid production of new materials, reduce waste and preserve a building's character. Retrofits have proven to be cost effective over the long-term in national studies.

Substantial amounts of information are available that document the energy saving benefits of retaining and repairing a historic window, rather than replacing it.

The following National Trust for Historic Preservation article at www.preservationnation.org provides additional information on the treatment of historic materials: *Saving Windows, Saving Money*

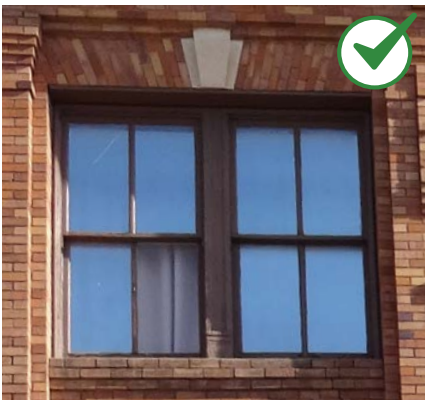

Operable double-hung windows enhance the energy efficiency of a building.

6. Enhance the energy efficiency of historic windows and doors.
 - a. Make the best use of historic windows; keep them in good repair and seal all the leaks.
 - b. Maintain the glazing compound regularly. Remove old putty with care.
 - c. Place a storm window internally to avoid a negative impact on the external appearance.
 - d. Use storm windows designed to match the historic window frame if placed externally.

D. Doors

The design, materials and location of historic doors and entries help establish the significance of a historic structure and should be preserved. When a new door is needed, it should be in character with the building.

1. Preserve a historic primary entrance.
 - a. Preserve historic and decorative features including door frames, sills, heads, jambs, moldings, detailing, transoms and flanking sidelights.
 - b. Do not alter the historic size and shape of a historic door opening.
 - c. Do not change the historic location of a door opening on a primary facade.
 - d. Do not add a new door opening on a primary facade.
 - e. Do not enclose transoms or sidelights.
2. Repair or replace a damaged door to maintain its general historic appearance.
 - a. Use materials that are similar to that of the historic door.
 - b. When replacing a historic door on a primary facade, use a design that is similar to the historic one.
3. When replacing a historic door on a non-primary facade, use a design that is in character with the building.
 - a. Locate and design a new door and entry to preserve the historic composition of the wall.
 - b. Locate a new door in a secondary location and be consistent with the historic architectural style of the structure.
 - c. Design a new door or entry to match historic door proportions.



Design a new door or entry to match historic door proportions.



Maintain a historic primary entrance.



Preserve historic doors and their openings.



Preserve historic and decorative features including door frames, sills, heads, jambs, moldings, detailing, transoms and flanking sidelights.

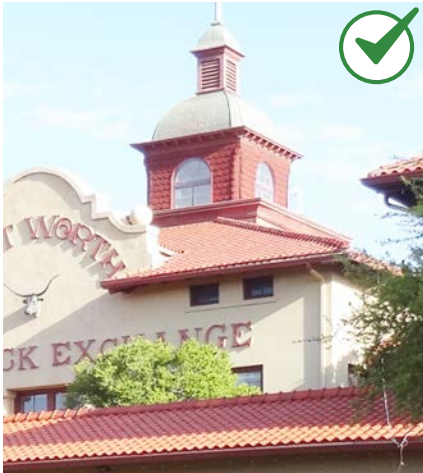

Use replacement roof materials that are similar in scale, texture, finish and color to traditional roof materials.



Maintain and repair roof detailing.



Do not alter a parapet on a highly visible facade.

E. Roofs

The form, shape and materials of an original roof help define the character of a historic structure and should be preserved. Where necessary, a new roof element, such as a dormer, may be added in a secondary location if it remains subordinate and in character with the design of the original structure.

1. Preserve the original roof line and shape on a historic structure.
 - a. Maintain the perceived line and orientation of the roof as seen from the street.
 - b. Avoid altering the angle of a historic roof.
 - c. Maintain the perceived roof line of flat-roofed buildings.
2. Maintain and repair original roof materials.
 - a. Retain and repair roof detailing, including gutters and downspouts.
 - b. Avoid removing historic roofing material that is in good condition or that can be repaired.
3. Use replacement roof materials that are similar in scale, texture, finish and color to traditional roof materials.
 - a. Replacing with the same material is preferred.
 - b. Consider the architectural style of the structure when an alternative material must be used.
 - c. Use a color similar to the original, or of the material as it would appear in weathered condition.
 - d. When an original roof material must be replaced, use a new material that is similar in scale, texture, finish and color.



Maintain the original roof line and shape on a historic structure. The roof of the Stockyards Station building (the historic sheep and hog pen area) is a distinctive feature that should be preserved.

F. Historic Commercial Storefronts

The storefront is a key defining feature of a historic commercial building and should be preserved. It is usually framed by masonry side walls and a horizontal molding or lintel above the storefront windows. Transoms over display windows are distinctive features. A store entrance is usually recessed behind the plane of the facade and a molding or lintel separates the storefront from upper floors. These guidelines are focused on the HSH-districts where commercial storefronts are typical. Preserving significant historic storefronts and reconstructing altered or missing storefront features is a key goal. Researching archival materials such as historic photos and building plans can be helpful in understanding the role of the storefront and its relationship to the street.

1. Preserve these character-defining features of a commercial facade:
 - a. Parapet: The portion of the building wall that extends above a flat roof surface.
 - b. Cornice: A decorative band at the top of the building.
 - c. Primary Material: Includes brick, stucco and wood, for example.
 - d. Upper-Story Windows: Windows located above the street level often have a vertical orientation.
 - e. Sign Band: A flat band running above the transoms to allow for the placement of signs.
 - f. Lintel: A horizontal structural member that supports a load over an opening; usually made of wood, stone or steel; may be exposed or obscured by wall covering
 - g. Transom: The upper portion of the display window, separated by a frame.
 - h. Pilaster: A rectangular column attached to a wall; quite frequently decoratively treated so as to repeat a classical column with a base, shaft and capital.
 - i. Display Windows: The main portion of glass on the storefront, where goods and services are displayed.
 - j. Door: Usually set back from the sidewalk in a protected recess.
 - k. Kickplate: Found beneath the display window.
 - l. Awning/Canopy: A sheltering attachment to the facade (not shown).

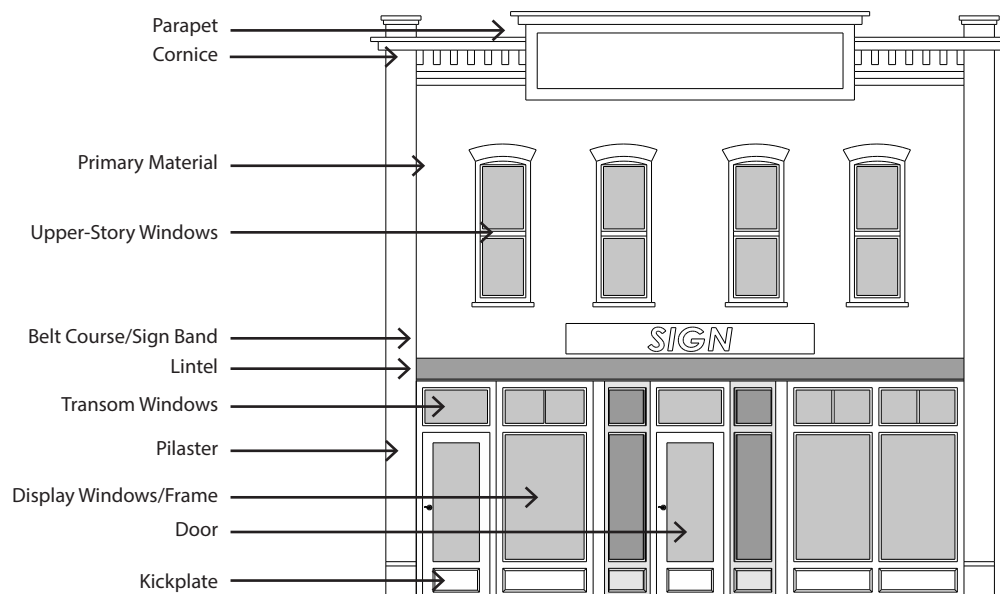

Preserve these character-defining features of a commercial facade.

HISTORIC STOREFRONT REHABILITATION



Before: Wood paneling obscures historic storefronts.



After: Original storefronts revealed.



Before: Original materials obscured



After: Historic storefront elements are exposed, following removal of non-historic stucco and other material.

2. Preserve a historic commercial storefront.
 - a. Preserve the storefront glass if it is intact.
 - b. Repair historic storefront elements by patching, splicing, consolidating or otherwise reinforcing the historic materials.
 - c. Do not alter the size and shape of a historic storefront opening.
 - d. Do not use reflective, opaque or tinted glass.
3. If a storefront is altered, restoring it to the original design is preferred.
 - a. Remove more recent coverings that obscure original features.
 - b. If evidence of the original design is missing, use a simplified interpretation of similar storefronts in a rehabilitation approach.
 - c. The new design should convey the character of a typical storefront, including the transparency of display windows.
 - d. Historic photographs of commercial buildings in the Stockyards area are available and should be used when determining the original character of a storefront design.
4. Reconstruct a missing storefront feature to match the historic design.
 - a. Use traditional materials such as masonry and wood.
 - b. If using historic material is not possible, use a compatible substitute that is similar in scale, finish and character to the historic material, and that has proven durability in the local climate.
 - c. Reference historical documentation to guide the design of a replacement feature; or design a simplified version of a similar element seen on nearby historic properties, if no documentation is available.
 - d. Expose historic storefront elements that have been covered by modern siding or other materials.
5. A simplified or contemporary interpretation of a traditional storefront may be considered where the historic storefront is missing and no evidence of it exists.

HISTORIC STOREFRONT REHABILITATION



Before: moderately altered historic building



After: rehabilitation of historic building with reconstructed cornice, new windows and simplified interpretation of historic storefronts.

- a. A new design that uses traditional features of a storefront is appropriate.
 - b. The new design should continue to convey the design character and materials of typical commercial storefronts. This includes the transparent character of the display windows.
6. Preserve the original shape of the transom glass in a historic storefront.
- a. Transoms, the upper glass band of traditional storefronts, introduced light into the depths of the building, saving on light costs. These bands should not be removed or enclosed.
 - b. The shape of the transom is important to the proportion of the storefront, and it should be preserved in its historic configuration.
 - c. If the original glass is missing, installing new glass is preferred. However, if the transom must be blocked out, be certain to retain the original proportions and framing divisions. One option might be to use it as a sign panel or decorative band.
7. Preserve an original kickplate.
- a. The kickplate, located below the display window, adds interesting detail to the streetscape and should be preserved.
 - b. If the original kickplate is covered with another material, consider exposing the original design.
8. If the original kickplate is missing, develop a sympathetic replacement design.
- a. Wood is an appropriate material for replacements on most styles. However, non-original materials may also be considered when appropriately used with the building style.



A simplified or contemporary interpretation of a traditional storefront may be considered where the historic storefront is missing and no evidence of it exists.



A compatible interpretation of a traditional storefront is appropriate where the original is missing.



If the original transom glass is missing, installing new glass is preferred. If a transom must be blocked out, be certain to retain the original proportions and framing divisions.



Preserve an original kickplate.

9. Preserve the character of a historic cornice or parapet.
 - a. Most historic commercial buildings have cornices to cap their facades. Their repetition along the street contributes to the visual continuity of the district.
 - b. Reconstruct a missing cornice when historic evidence is available.
 - i. Use historic photographs to determine design details of the original cornice.
 - ii. A replacement should match the original in overall size and profile.
 - iii. The substitution of another old cornice for the original may be considered, provided the substitute is similar to the original.
10. Do not alter a parapet or cornice on a highly visible facade.
 - a. Inspect parapets on a regular basis. They are exposed to the weather more than other parts of the building, so watch for deterioration such as missing mortar or excessive moisture retention.
 - b. Avoid waterproofing treatments which can interfere with the parapet's natural ability to dry out quickly when it gets wet.
 - c. Adding coping to a parapet in order to protect masonry is appropriate.
11. Design a simplified interpretation of a historic cornice if evidence of the original is missing.
 - a. Appropriate materials include brick, stamped metal, wood and some durable synthetics.
 - b. Simple sheet metal is inappropriate.

G. Awnings, Canopies and Galleries

Awnings, canopies and galleries shelter walkways and shade windows. They are important features of many historic buildings. Awnings are typically made of fabric whereas canopies and galleries are rigid frames, usually composed of wood and metal. Traditionally, awnings, canopies and galleries were noteworthy features of many buildings and their continued use is encouraged. They are typically simple in detail, color and design. Operable awnings also help regulate internal climatic conditions.

In the early years, galleries were used on the original wood frame buildings. They had sloping shed roofs, which were supported on milled, finished wood posts. As masonry buildings were erected, flat, horizontal canopies were installed. These usually were supported by metal rods or chains from each building face, but galleries continued to have posts, either of finished wood or even metal. Fabric awnings also were used. These were tailored to fit the openings they were intended to shelter. A traditional, square shop front window had a square fabric awning, while an arched opening had a curving fabric form. This tradition of fitting the shape of an awning to fit the character of the building and its opening should be continued with any new designs. Note that some wood canopies and galleries that exist today have “rustic” unfinished characteristics that are not historically accurate.



SEE SEC. 5.1.4 FOR AWNING, CANOPY AND GALLERY STANDARDS

1. Preserve a historic awning, canopy or gallery where it exists.
 - a. Repair, rather than replace, an awning, canopy or gallery when feasible.
2. Reconstruct a missing awning, canopy or gallery based on evidence of its existence.
 - a. Consider removing a more recently installed canopy or gallery that does not have historic significance and that is out of character with the period of historic significance. For example, a “rustic” wood canopy or gallery is not historically significant.
3. Design a new canopy or gallery to be in character with the building and the Historic District.
 - a. A flat canopy or gallery form is appropriate. A shallow sloped form may be used where historic documentation substantiates that it once existed.
 - b. A canopy or gallery should have a metal roof structure.



Use a simple flat-topped gallery if the opening is square.



Appropriate canopy supporting mechanisms are wall mounted brackets, cable suspended columns or chains consistent with the style of the building.



Preserve a historic gallery where it exists.



Do not install curved form awnings on a rectangular opening or use colors that are not compatible with the structure.



A "rustic" wood canopy is not historically significant.

- c. Mount a canopy or gallery to accentuate character-defining features of the building, such as the line of transom windows above street level display windows. Avoid covering or obscuring significant architectural features.
 - d. Appropriate supporting mechanisms are wall mounted brackets, chains or columns consistent with the style of the building.
 - e. Internal illumination of an awning is inappropriate.
 - f. Materials should have finished, painted surfaces. Rustic materials, such as peeled log posts and split shake shingles are not authentic to the historic period of significance and should not be used.
 - g. Shielded lights may be installed on the underside of a canopy.
4. Design a new awning to be in character with the building and the Historic District.
- a. Mount an awning to accentuate character-defining features of the building.
 - b. Design an awning to be in proportion (opening, width, height) to the building.
 - c. Fit the shape of the awning to the opening. Simple shed shapes are appropriate for rectangular openings. Odd shapes, bull nose and bubble awnings are inappropriate for traditional storefronts. Arched awnings are appropriate on arched openings.
 - d. Internal illumination of an awning is inappropriate.
 - e. Avoid covering or obscuring significant architectural features.
 - f. Use a fabric with a matte finish. A glossy or reflective material is inappropriate.

Historic Canopy Rehabilitation



Before: moderately altered historic canopy



After: rehabilitation includes a reconstructed historic storefront, a historically accurate canopy and exposed original materials

H. Color

Choosing the right combination of colors for a historic rehabilitation project can unify building elements with the facade and highlight important architectural detailing. Paint color selection should be appropriate to the architectural style and complement the building and its surroundings. Using the historic color scheme is an option, but new schemes that are compatible are also permitted.

1. Retain historic colors.
 - a. Retain the historic or early color and texture of masonry surfaces.
 - b. Retain historic coatings such as paint that help protect exterior materials from moisture and ultraviolet light.
 - c. Do not strip paint or other coatings to reveal bare wood.
 - d. Do not paint unpainted masonry and architectural metals.
 - e. Do not use destructive paint removal methods such as propane or butane torches, sandblasting or water blasting which can irreversibly damage historic materials.

2. Use a color scheme that is compatible with the historic character of the structure.
 - a. Restore historic paint colors and finishes to the extent feasible to highlight the structure's historic appearance.
 - b. Repaint with colors that are appropriate to the period of historic significance of the building and the district. Color selection should be based on historic paint analysis of the historic layers of paint or appropriate historic research.
 - c. Use color schemes that are simple in character. (Generally one to three accent colors for trim elements on commercial buildings. Mission buildings typically only had one color accent).
 - d. Seek professional advice and properly prepare surfaces before painting.

The City does not regulate color; however, a change in “character” that arises from a change in color can be regulated. For example, a color scheme that obscures key character-defining features may be subject to review.



Retain historic coatings such as paint that help protect exterior materials from moisture and ultraviolet light.



Use a color scheme that is compatible with the historic character of the structure.



Preserve an older addition that has achieved historic significance in its own right.

I. Existing Additions

Some existing additions may have become historically significant in their own right. Unless the building is being accurately restored to an earlier period of significance, additions that have taken on significance may merit preservation. However, more recent additions may detract from the character of the building and could be considered for removal.

1. Preserve an older addition that has achieved historic significance in its own right.
 - a. Respect character-defining building components of a historically-significant addition.
 - b. Do not demolish a historically-significant addition on a key landmark structure, unless restoration to an earlier period is planned, or a new, compatible alteration would be appropriate.
2. Consider removing an addition that is not historically significant.
 - a. Ensure that the historic fabric of the primary structure is not damaged when removing these features.

J. New Additions

A new addition that is compatible with the historic building and its surrounding historic context may be permitted when it remains visually subordinate and minimizes loss of historic building material. It is important to consider its design and placement, as well as its relationship to the surrounding historic context. A rooftop addition is more likely to be compatible on a traditional commercial storefront building, such as those found along West Exchange and Main Street. Some other building types could accommodate a rooftop addition when the historic roof form would not be affected and the appearance would be minimized.

1. Design an addition to be compatible with the historic structure.
 - a. Do not use replicas of historic building components and details that would convey a false history or that would draw undue attention to the addition.
 - b. Use materials that are of a similar color, texture and scale to materials in the surrounding historic context.
 - c. Design an addition to be compatible with the scale, massing and rhythm of the surrounding historic context.
 - d. Incorporate windows, doors and other openings at a consistent solid-to-void ratio to those found on adjacent and nearby historic buildings.
 - e. Use simplified versions of building components and details found in the surrounding historic context such that the new addition does not visually overwhelm the original. These may include: a cornice; a distinctive storefront or main door surround; window sills or other features.
2. Design an addition to be subordinate to the historic building.
 - a. Place an addition to the side or the rear of the historic structure.
 - b. Do not locate an addition where it would negatively affect key character-defining features.
3. Differentiate an addition from the historic structure.
 - a. Use changes in material, color and/or wall plane.
 - b. Distinguish the addition as new, albeit in a subtle way.
 - c. Use a simplified or contemporary interpretation of building components such as windows, doors, railings, cornices.

Locating an Addition to a Historic Commercial Building:

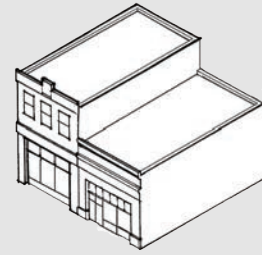

Historic Structures
The one and two-story commercial buildings illustrated above are historic.

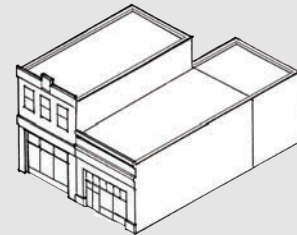

Rear Addition
The rear addition illustrated above is appropriate.

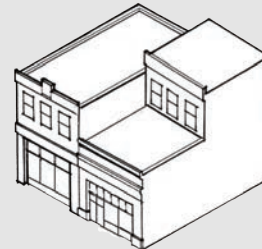

Rooftop Addition
The rooftop addition illustrated above is appropriate because it is set back from the front facade.



Design an addition to be subordinate to the historic building.



Design an addition to be subordinate to the historic building.

4. Minimize damage to historic fabric when designing an addition.
 - a. Do not damage or obscure significant architectural features of the historic building.



This three-story roof addition and side addition overwhelms the historic building due to its disproportion in mass and scale.

Special Opportunities for New Additions



Some special opportunities may exist where a contemporary addition may be “inserted” into a shell of a historic structure.



An addition, located along a secondary wall retains the ability to perceive the historic character of the building.

K. Rooftop Additions

A primary objective in designing a new addition is to assure that it will be visually subordinate to the historic building, such that the character of the original may still be seen. This means that the addition should be simple in its design, such that it does not draw attention away from the historic structure.

An addition also should be positioned such that the historic scale and proportions of the original can be seen. Keeping the height of the addition lower than the height of the historic building is important. Setting it back, away from historically significant walls, such that the original height is clearly seen is also important.

How an addition will be perceived by a pedestrian on the street will influence the distance it should be set back. While this will be considered on a case-by-case basis, a general rule of thumb is that a rooftop addition should be set back from the facade at a distance that is greater than the height of the historic wall.

Setback of a Rooftop Addition on a mid-block site



Original Building



One-story addition stepped back from historic facade

In general, a rooftop addition on a historic building should be set back from the primary facade to be subordinate to the original structure. The addition should be visually minimized from the street level perspective, and should be oriented in the same direction as the original building and adjacent buildings.

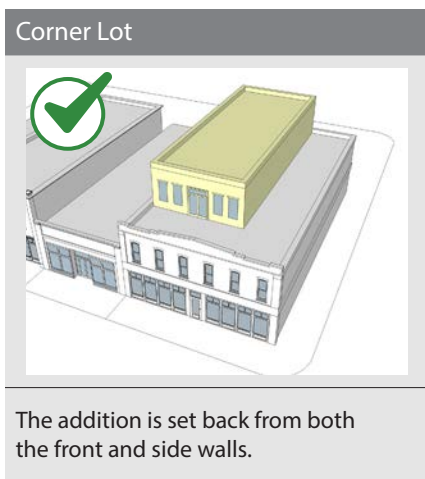

Corner Lot

The addition is set back from both the front and side walls.

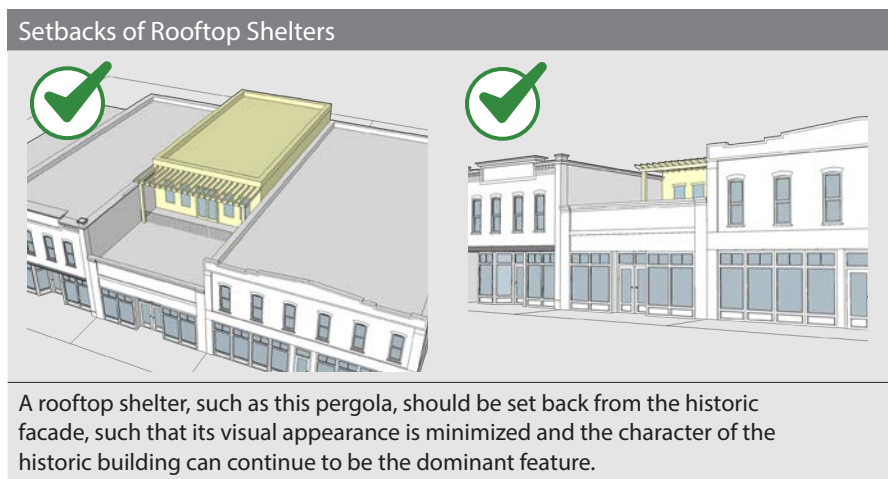

Setbacks of Rooftop Shelters

A rooftop shelter, such as this pergola, should be set back from the historic facade, such that its visual appearance is minimized and the character of the historic building can continue to be the dominant feature.

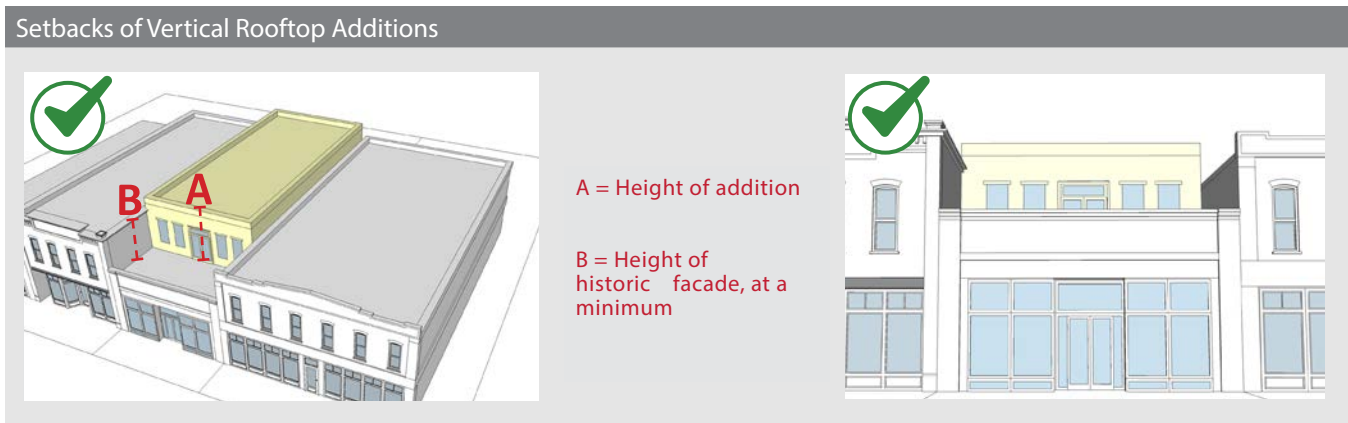

Setbacks of Vertical Rooftop Additions

A = Height of addition

B = Height of historic facade, at a minimum



This rooftop deck is set too close to the edge of the historic building wall and impedes one's ability to interpret the historic scale and character of the original structure.

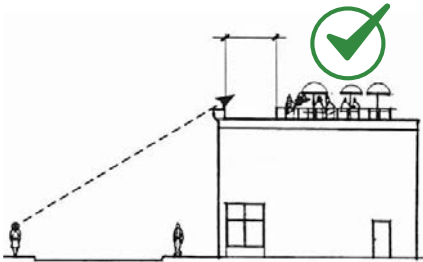

Rooftop gardens, furnishings and enclosure apparatus should be setback significantly from the front facade in the same way as a rooftop addition.

1. Design a rooftop addition to be compatible with the historic building.
 - a. A compatible rooftop addition should be:
 - i. Set back from the primary, character-defining facade to preserve the perception of the historic scale of the building.
 - ii. Modest in character, so it will not detract from the historic facade.
 - iii. Set back from a secondary facade in case of a corner property.

L. Rooftop Decks and Gardens

A rooftop deck or garden can expand outdoor use opportunities on the roof of a building when such a feature is set back sufficiently to maintain the character of the historic facade. This is mainly anticipated to apply in an HSH- district; additions in an HCO- district will be considered much more carefully. In each case, the ability to perceive the historic character should be preserved.

1. Locate a rooftop deck or garden to minimize visual impacts on the historic building.
 - a. Rooftop furnishings, gardens and enclosure apparatus should be setback significantly from the front facade in the same way as a rooftop addition.
 - b. A projecting or overhanging deck is inappropriate on the front of a building. It may be allowed on the rear of the building if it does not negatively impact neighboring historic resources.
 - c. A rooftop shelter (such as a pergola, awning, canopy) should be set back from the primary facade in the same way as a rooftop addition.
 - d. A rooftop shelter on a building located at a corner should be set back from both primary and secondary facades in the same way as a rooftop addition.

M. Energy Efficiency

Keeping older buildings in use avoids environmental impacts associated with new construction. Maintaining and improving energy efficiency and providing options for energy generation further promotes the sustainability of historic buildings.

1. Preserve the inherent energy efficient features of the original building in operable condition.
 - a. Identify a building's inherent sustainable features and operating systems and maintain them in good condition.
 - b. Repair or restore covered, damaged or missing features where appropriate.
 - c. Retain and repair original roof material.
 - d. Retain original, awnings, canopies and transoms.

2. Install compatible energy-efficiency improvements that enhance the energy saving features of the original structure.
 - a. Use cost-effective weather-stripping, insulation and storm windows to improve energy efficiency while remaining historically sensitive.
 - b. Install weatherization strategies in a way that avoids altering or damaging significant materials and their finishes.
 - c. Use materials which are environmentally friendly and that will not interact negatively with historic building materials and their finishes.
 - d. Make best use of original windows; keep them in good repair and seal all leaks.
 - e. Use operable systems such as storm windows (see pg. 42), insulated coverings, curtains and awnings to enhance performance of original windows.

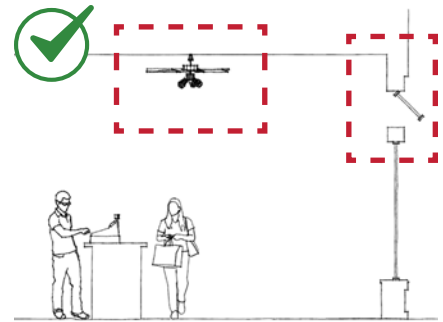

Preserve the inherent energy efficient features of the original building in operable condition.

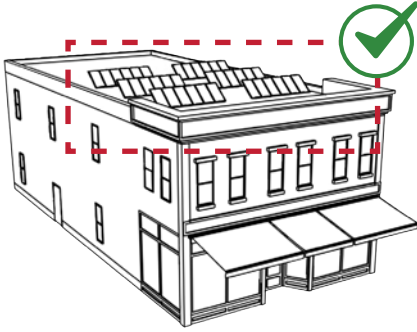

Place a solar array to avoid obscuring significant features or adversely affecting the perception of the overall character of the property.



Design the scale and location of a wind turbine to remain subordinate to the historic structure.

3. Locate an energy generating device to minimize impacts to the historic character of the resource.
 - a. Locate technology where it will not damage, obscure or cause removal of significant features or materials.
 - b. Maintain the historic character of the building.
 - c. Locate devices where they are not visible on the front facade. If they are located on the roof, set them back significantly so they are not visible from the street.
4. Install new technology in a reversible manner.
 - a. Install energy generating devices in such a way that they can be readily removed and the original character can be easily restored.
 - b. Use materials which are environmentally friendly and that will not interact negatively with historic building materials.
5. Minimize adverse effects of a solar array or wind turbine on the character of a historic building.
 - a. Place the equipment to avoid obscuring significant features or adversely affecting the perception of the overall character of the property.
 - b. Size the equipment to remain subordinate to the historic structure.
 - c. Minimize visual impacts by locating the equipment back from the front facade.
 - d. Consider installing the equipment on an addition or secondary structure where applicable.
 - e. Exposed hardware, frames and piping should have a matte finish, and be consistent with the color scheme of the primary structure.
6. Use the least invasive method feasible to attach a solar array or wind turbine to a historic roof.
 - a. Avoid damage to significant features.
 - b. This equipment should not threaten the structural integrity of the building.

HISTORIC COMMERCIAL STOREFRONT BUILDING ENERGY-EFFICIENCY DIAGRAM

This diagram illustrates a general strategy for energy conservation on a historic commercial building. These measures can enhance energy efficiency while retaining the integrity of the historic structure.

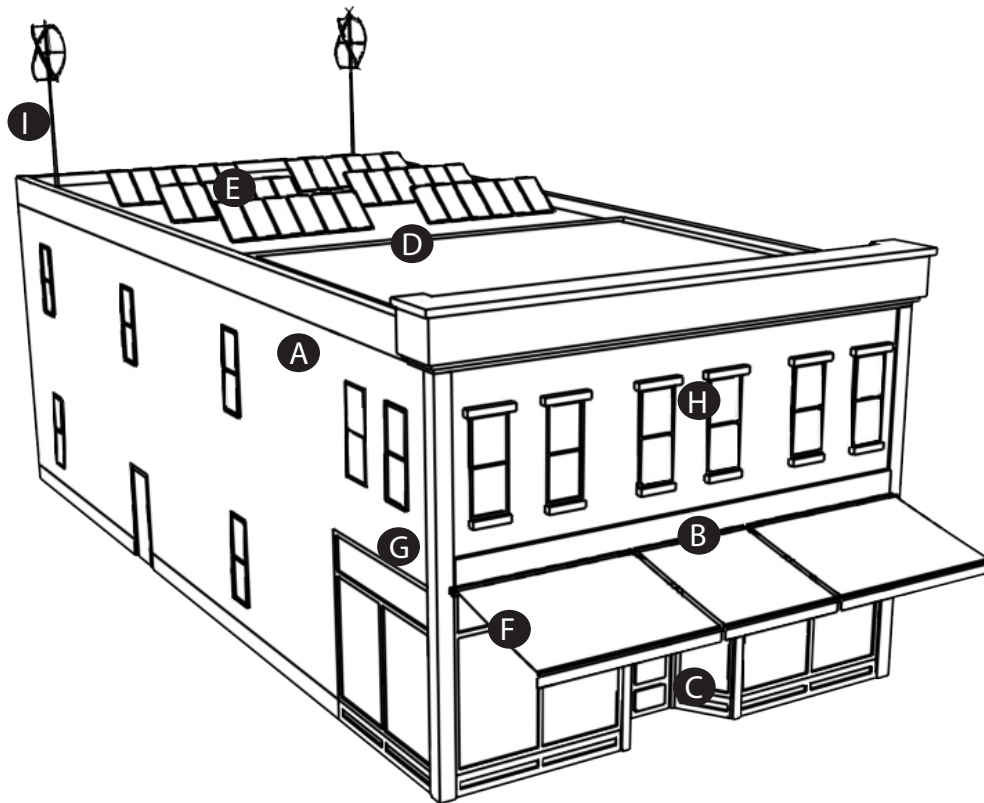

- | | | |
|---|--|---|
| <p>A Attic • Insulate internally</p> | <p>D Roof Material • Retain & repair</p> | <p>G Transom/Clerestory Windows • Retain operable clerestory window to circulate air</p> |
| <p>B Awnings • Use operable awnings to control solar access and heat gain</p> | <p>E Solar Panels • Set back from primary facade to minimize visibility from street</p> | <p>H Windows • Maintain original windows • Weather-strip and caulk • Add storm windows (preferably interior)</p> |
| <p>C Doors • Maintain original doors • Weather-strip • Consider interior air lock area</p> | <p>F Display Windows • Maintain original windows • Weather-strip</p> | <p>I Wind Turbines • Set back from primary facade to minimize visibility from street</p> |

ENERGY EFFICIENCY STRATEGY

Follow the basic steps below when considering a rehabilitation project for energy efficiency.

Step 1: Establish Project Goals

Develop an overall strategy and project goals to maximize the effectiveness of a project. Developing clear project goals will establish a broad view that can help place individual actions into context. These should focus on minimizing use of resources and energy, minimizing negative environmental impacts, and retaining the historic integrity of a property. Strategies should maximize the inherent value of the historic resource prior to considering alterations or energy generation technology.

To inform a project strategy, consider conducting an energy audit. Energy audits can give a comprehensive view of how energy is currently used, in the daily and seasonal cycles of use, and can also provide perspective on the payback of investment for potential work on the building. For example, an energy audit, when examined based on an overall strategy, may demonstrate that priorities should be on increasing insulation in walls, ceilings and foundations, rather than replacing windows.

Step 2: Maintain Building Components in Sound Condition

Maintaining existing building fabric reduces negative environmental impacts. Re-using a building preserves the energy and resources invested in its construction, and removes the need for producing new construction materials.

Step 3: Maximize Inherent Sustainable Qualities

Typically, historic buildings were built with resource and energy efficiency in mind. Construction methods focused on durability and maintenance, resulting in individual building features that can be repaired if damaged, thus minimizing the use of materials throughout the building's life cycle. Buildings were also constructed to respond to local climate conditions, integrating passive and active strategies for year-round interior climate control, which increase energy efficiency. Passive strategies typically include building orientation and features such as roof overhangs and windows to provide both natural daylighting as well as management of solar heat gain. Active strategies typically include operable building features such as awnings and double-hung/clerestory and transom windows. Identify a building's inherent sustainable features and operating systems and maintain them in good operating condition. In some cases, these features may be covered, damaged or missing; repair or restore them where necessary.

Step 4: Enhance Building Performance

A historic building's inherent energy efficiency can be augmented using techniques which improve efficiency without negatively impacting historic building elements. Non-invasive strategies such as increased insulation, weatherization improvements and landscaping should be considered.

Step 5: Add Energy-Generating Technologies Sensitively

The flexibility of many historic structures allows for the respectful integration of energy efficiency technologies. Energy-generating technologies are the most commonly known strategies. However, the efficiency of a historic structure will often be great enough that generation technologies are not the most practical solutions. Utilize strategies to reduce energy consumption prior to undertaking an energy generation project.

When integrating modern energy technology into a historic structure, maintain the resource's historic integrity and the ability to interpret its historic significance. As new technologies are tried and tested it is important that they be installed in a reversible manner such that they leave no permanent negative impacts to a historic structure.

N. Accessibility

Where it applies, an owner of historic properties should comply, to the fullest extent possible, with Americans with Disabilities Act (ADA) provisions and Texas Accessibility Standards (TAS), while also preserving the integrity of the key character-defining features of the building.

1. Preserve the integrity and character-defining features of a historic building when integrating accessibility solutions.
 - a. Identify the historic building's character-defining spaces, features and finishes so that accessibility code-required work will not result in their damage or loss.
 - b. Alterations to historic properties that are designed to improve access for persons with mobility impairments should minimize negative effects on the historic character or materials.
 - c. Provide barrier-free access that promotes independence for the disabled and others with mobility impairments to the highest degree practicable, while preserving significant historic features.



Preserve the integrity and character-defining features of a historic building when integrating accessibility solutions.

O. Rehabilitation and Changing Use

Reusing a building preserves the energy and resources invested in its construction, and removes the need for producing new construction materials, significantly reducing environmental impacts.

The best use for a historic structure is that for which it was originally designed, or at least a closely related one. A new use may be introduced if it does not adversely affect the historic integrity of the building and its site.

1. Seek uses that are compatible with the historic character of the building.
 - a. The use should help interpret how the building was used historically.
 - b. The use should not adversely affect the historic integrity of the building or alter character-defining features of the building.
2. Seek uses that require minimal change to the original structure.
 - a. When a significant change in use is necessary to keep the building in active service, those uses that require the least alteration to significant elements are preferred.
 - b. Adaptive reuse may be inappropriate if the new use would require radical alteration to the historic building's key character-defining features. In most cases, however, designs can be developed that respect the historic integrity of the building while also accommodating new functions.
3. Seek upper floor uses that preserve the historic integrity of the original building while maintaining it in active use.



A change in use that requires alteration of key features, such as this, should be avoided.

- a. Commercial office space is the most common upper-floor use for traditional commercial buildings.
 - b. Upper-story floors of adjacent historic buildings may be combined if the character-defining features of the building's facade are maintained.
 - c. Elevators may be added to the rear of historic buildings to provide accessibility to upper floors.
4. Activate an historic public open space through adaptive reuse.
- a. An adaptive reuse program for a historic open space should enliven it while maintaining its historical character.
 - b. An adaptive reuse program for a historic open space should consider the following to enliven a space:
 - i. New events, music and performance opportunities
 - ii. Opportunities for educational and interpretive elements



An adaptive reuse program for a historic open space should enliven a space while maintaining its historical character.

P. Phasing/Interim Design

A rehabilitation project may be phased to accommodate market conditions or financing availability. For example, a project may begin with the removal of alterations to a historic facade, followed by complete facade rehabilitation at a later date. In such a case, it is important that the interim work not diminish the integrity of the property and that it keep future restoration options remain open.

1. Plan a phased rehabilitation project to allow for future compatible improvements.
 - a. Consider removing a non-historic alteration as an initial phase.
 - b. Consider ground floor storefront improvements that may set the stage for a later restoration of the complete building facade.
 - c. In phased project, do not remove or alter character-defining features of a building in a way that would preclude later restoration.
2. Program a regular and thorough maintenance schedule to protect the character-defining features of a historic building.
 - a. Plan maintenance to address the effects of seasonal weather conditions.
 - b. Pay particular attention to areas that are exposed or where water may gather.
 - c. Review the building interior for any signs of distress or failure.
 - d. Act on the first signs of any deterioration to avoid later interventions that are likely to be more costly.

A Phased Rehabilitation



The Meissner-Brown Funeral Home was built in 1937.



Once scheduled for demolition the building was not maintained and was left abandoned and dilapidated.



Phase 1 Rehabilitation: Interim improvements to the building included reopening the transom, providing a new sign and reconstructing the kickplate.



Phase 2 Rehabilitation: A later work included removing the stucco, reconstructing the cornice and installing a new storefront.

Q. Archaeological Resources

Negative impacts on archaeological resources should be avoided.

1. Leave archaeological resources in place, to the maximum extent feasible.
 - a. Avoid disturbing known archaeological resources.
 - b. If archaeological materials are discovered contact the City of Fort Worth Historic Preservation Office.

R. Signs

All historic signs should be retained. Historic signs are an important element in the Historic District that contributes to the overall character and heritage of the area. Older signs (1960's and earlier) may have taken on historic significance and may warrant preservation.



SEE DIV. 7.4 FOR SIGN STANDARDS

1. Consider history, context and design when determining whether to retain a sign.
2. A sign should be retained when:
 - a. Associated with historic figures, events or places
 - b. Significant as evidence of the history of the product, business or service advertised
 - c. A significant part of the history of the building or district
 - d. Characteristic of a specific historic period
 - e. Integral to the building's design or physical fabric
 - f. Integrated into the design of a building such that removal could harm the integrity of a historic property's design or cause significant damage to its materials
 - g. An outstanding example of the sign maker's art because of its craftsmanship, use of materials or design
 - h. A historically significant sign type
3. Leave a historic wall sign visible.
 - a. Do not paint over a historic sign.
 - b. There are times when some alterations to a historic wall sign may be permitted; these are:
 - i. If the sign is substantially deteriorated, patching and repairing is permitted.
 - ii. If the sign serves a continuing use, i.e., there are older signs that still have an active business and they need to change information such as hours of operation.

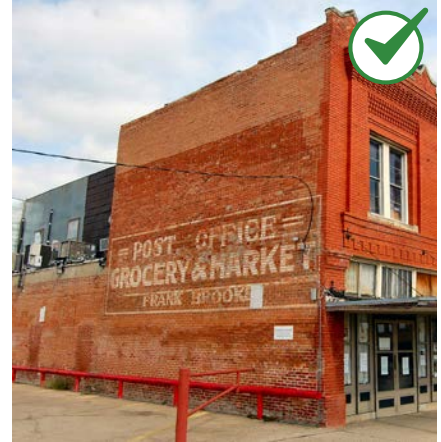

Leave a historic wall sign visible.



A sign should not obscure character-defining features of a historic building.

4. Do not over restore a historic wall sign.
 - a. Do not restore a historic wall sign to the point that all evidence of its age is lost.
 - b. Do not significantly re-paint a historic wall sign even if its appearance and form is recaptured.

5. Sign Installation on a Historic Building

When installing a new sign on a historic building, it is important to maintain the key architectural features of and minimize potential damage to the building.



SEE DIV. 7.4 FOR SIGN STANDARDS

1. Do not damage or obscure architectural details or other building features when installing a sign.
 - a. No sign or sign structure/support should be placed onto or obscure or damage any significant architectural feature of a building, including but not limited to a window or a door frame, cornice, molding, ornamental feature, or unusual or fragile material.
2. A sign should not obscure character-defining features of a historic building.
 - a. A sign should be designed to integrate with the architectural features of a building, not distract from them.
 - b. No sign should be painted onto any significant architectural feature, including but not limited to a wall, window or door frame, cornice, molding, ornamental feature, or unusual or fragile material.
 - c. No support for a sign should extend above the cornice line of a building to which the sign is attached.

SEC. 2.4.4. STANDARDS AND GUIDELINES FOR NON-CONTRIBUTING BUILDINGS AND NEW CONSTRUCTION

This section applies to new construction and to alterations of non-contributing buildings. It applies to all walls of buildings and site features that are visible from the public way.

It is important that any new construction or the alteration of non-contributing properties contribute to a consistent sense of character and respect the historic context, while also conveying the evolution of the historic district. It is not the intent that new buildings imitate older styles, but that they draw upon basic elements seen historically while doing so in ways that express their own time.

Compatibility with the historic context is a key principle for the design of new construction or to the alterations of non-contributing properties. This typically focuses on buildings on the same block, on both sides of the street, and also across an alley. In some cases, a structure that is not historic may also be found in the immediate vicinity, but this does not influence considerations of compatibility.



Design a new building to reflect its time while respecting key features of the historic context.



Use high quality design and depth of detail in building features to enhance compatibility with the historic context.



Continue the tradition of simple rectangular building forms.

A. Architectural Character

New buildings should be distinguishable from historic buildings so as not to confuse the history of the area. They should appear as products of their own time while maintaining compatibility with the historic context. Generally, in an HCO- district it is important that new construction be visually subordinate to the historic context.



SEE DIV. 5.2 FOR ARCHITECTURAL STANDARDS

1. Design a new building to complement its time while respecting key features of the historic context.
 - a. Reference traditional articulation patterns on the facade of a new building.
 - b. Use high quality design and depth of detail in building features to enhance compatibility with the historic context.
 - c. Use simple details, when appropriate, such as window moldings and door surrounds, to create interest while expressing a building of its time.

B. Building Form

Historically most buildings in the Historic District had simple rectangular forms, which typically expressed the width of the underlying lots. Larger buildings were composed of a set of these simple forms (such as the White Elephant Saloon). This tradition should be continued.



SEE SEC. 5.2.2 FOR BUILDING FORM STANDARDS

1. Continue the tradition of simple rectangular building forms.
 - a. Irregularly shaped footprints are inappropriate.
 - b. Forms should appear to be in scale with the historic buildings that survive in this area.
 - c. A curved or angular building element may be used as an accent to a primary rectilinear form.

C. Roof Form

Historically, flat roofs were used, or at least they appeared to be so because they were concealed behind parapets. Roof forms in new construction should continue this tradition. Historically, a range of roof forms were used in the HCO-40, HCO-60 and HCO-68 districts. These included hip and gable roofs. Some had barrel vault or shed forms. The stepped flat roof form of the Stockyards Station building, with its clerestories is an example of another distinctive form. Even though forms varied, many of them were screened by parapets and thus the overall sense of the range of roof forms is more limited. The roof of the Coliseum and the Stock Exchange are the distinctive accents in this district, and they should continue to be so. Therefore, roof forms on new construction should remain simple in character.

1. Use simple roof forms.



SEE SEC. 5.2.1 FOR ROOF FORM STANDARDS

- a. A flat roof should be the predominant form.
- b. Shed, gable or hip forms may be used for secondary building elements.
- c. In HCO-55, gable and hip roof forms are appropriate primary forms in the Armour/Swift sites.

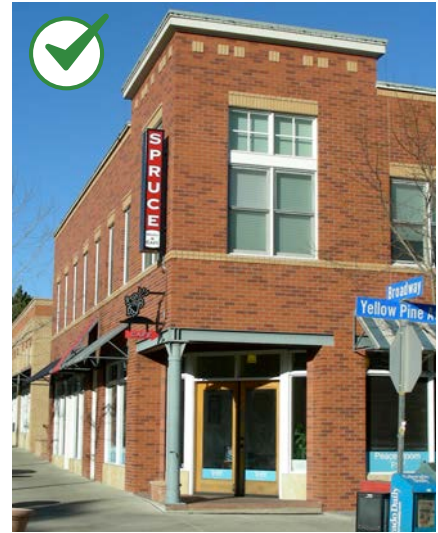

A flat roof should be the predominant form.



A flat roof should be the predominant form.



Provide articulation in building walls that are perceived from streets, walkways, open spaces and other public ways that reflect historic precedents in the district.

D. Building Massing

While building forms were simple, some variation in massing existed, usually by a change in parapet height, and expression of vertical elements and other articulation methods. This variation in massing helped to establish a sense of a lower scale in this area and should be continued.

Generally, in HCO-55, a central mass may have been framed by subordinate building “modules.” This variation in massing is still apparent on the Armour Laboratory building. This helped to establish a sense of a lower scale in this area. This tradition should be continued.

1. Provide variation in massing to express the scale of historic development.
 - a. Use a variation in building height and other articulation methods.
 - b. Use variation that is sufficient in change of massing to express traditional lot widths.
 - c. In HCO-40, HCO-60 and HCO-68, keep forms relatively simple, with a central mass. Other smaller masses should appear to be attached. Stepped forms are also appropriate.
2. Design the facade height to appear to be within the range seen historically in the area.
 - a. Design the facade to complement the traditional proportions of height to width.
 - b. Clearly differentiate the ground floor, middle floors and roof form.



Provide variation in massing to express the scale of historic development.

E. Articulation

Historically, buildings in this area had a high degree of “articulation” along a block face, as seen from the street. This included changes in wall heights and variations in window patterns between adjacent buildings and throughout the building street wall. This tradition should be continued.

1. Provide articulation in building walls that are perceived from streets, walkways, open spaces and other public ways that complement historic precedents in the district.
 - a. The dimensions of various articulation devices must be substantial enough to appear authentic and to genuinely contribute to a sense of variation in massing and add visual interest.
 - b. In comparison with the other parts of the Historic District, the HCO-40 District had a “moderate” degree of articulation in building designs. This tradition should be continued.
2. Provide a first floor height similar to historic buildings that incorporates the traditional height of a base, middle and cap.
3. On upper floors, locate windows to be consistent with the historic window patterns in the district.
 - a. Use traditional proportions of windows, individually or in groups.
 - b. Maintain the traditional placement of window headers and sills relative to cornices and belt courses.
4. Design the ground floor of a building facade to have a sense of scale and visual interest to engage the public realm.
 - a. Clearly define a building entry and orient it towards the street.
 - b. Use architectural details and fenestration to emphasize a primary building entry.



Use vertical and horizontal articulation design techniques to reduce the apparent scale of a larger building mass.

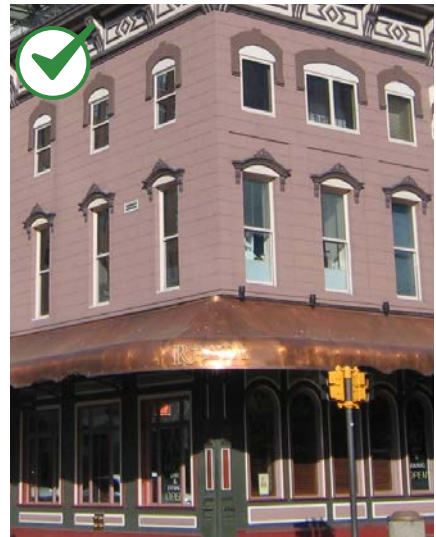

The percentage of window to wall should remain subordinate.



Provide design features that activate the street wall and provide visual interest.



F. Building Materials

Building materials should contribute to the visual continuity of the historic district. The material should be authentic and genuine, maintaining similar scale, color, texture and finish of those used historically. Appropriate materials may vary depending on whether the material is used as a primary material or a secondary material. A primary material is one that covers the majority of the surface area of a prominent face of a building. A secondary material is also a part of a building's walls but is subordinate to the primary material. Finally other materials may appear as accents, as trim materials, on limited panels as relief or on window sills.



Use materials that appear similar in scale to those used historically.

Historically, the palette of primary building materials was rather limited in the HSH-districts, with brick being by far the predominant material. New buildings in the area should continue to use brick as the primary building material.

Genuine stucco was used on the Coliseum and Exchange buildings, as well as on the north walls of the horse and mule barns, while the horse and mule barns themselves were of brick. The hog and sheep sheds were initially wood frame and later were replaced with concrete support structures. The pens themselves continued to be wood frame. New buildings should continue to use brick as the primary building material, in part to serve as a "bridge" between the HSH-40 and HCO-55 districts, where brick also should be the predominant material.

1. Use materials that appear authentic and that are proven durable in this setting.
 - a. They should have a texture and finish similar to that used historically.



SEE SEC. 5.2.4 FOR PRIMARY AND SECONDARY BUILDING MATERIAL STANDARDS

2. Use materials that appear similar in scale to those used historically.
 - a. For example, use brick that is similar in size to that used historically.
 - b. In HSH- districts, more variety in materials is appropriate on walls that face toward TNX- districts.

G. Transparency



SEE SEC. DIV. 2.2 FOR TRANSPARENCY STANDARDS

Transparency patterns should appear similar to those seen historically while accommodating new contemporary uses. These patterns vary by the different Form Districts.

1. Maintain traditional transparency patterns.
 - a. Upper floors should have a lower percentage of glass in comparison with the street level.
 - b. Windows that have a vertical orientation are preferred.
 - c. Windows should have a substantial depth of framing or be inset enough to create distinct shadow lines.
2. Windows should align with historic patterns.
 - a. This is particularly important in HSH- districts, where this is a distinct characteristic.



Windows should align with historic patterns.



SEC. 2.4.5. STANDARDS AND GUIDELINES FOR SITE DESIGN

This section applies to the preservation of historic landscapes and site features as well as the design and construction of new ones.

It is important that landscapes and site features contribute to a sense of continuity and that they respect the historic context. Landscapes and site features also should convey the differences in distinctly different sub-areas of the historic district.

Compatibility with the historic context is a key principle for the design of landscapes and site features. In terms of those elements within the historic district, three distinctly different settings exist, based on historic precedents:

1. HSH-40, HSH-68

This area reflects a traditional "Main Street" character with painted, ornamental metal street light poles and benches that are urban in character.

2. HCO-40, HCO-60, HCO-68

These areas reflect the "cowboy heritage" that is characterized by more rustic site furnishings. Wood framing used in site furnishings, predominantly seen in historic cattle pens and smaller sales buildings, is an example. Brick paving in livestock walkways and pens also is a part of this vocabulary of site design.

3. HCO-55

Historically, site features in this area were more "industrial" in nature, often being constructed with metal and masonry materials.



The traditional "Main Street" character of the HSH-40 District is reflected with painted, ornamental metal features.

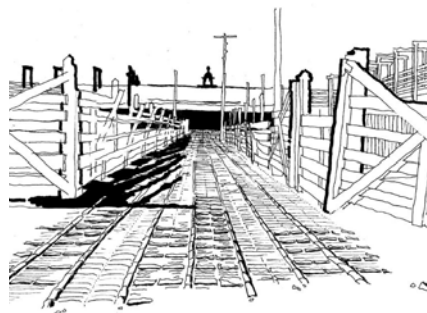

Cattle pens are important elements of the "Central Stockyards" and serve as precedent for site designs for the HCO-40, HCO-60 and HCO-68 districts.

A. Connectivity

Connectivity and circulation patterns should complement those that existed historically. Historic circulation networks included walkways, rail lines and cattle runs. The vestiges of these networks should be preserved. New development should consider how the historic circulation routes may be framed and utilized.

1. Retain the historic network of streets and alleys.



SEE ARTICLE 8 FOR CONNECTIVITY AND CIRCULATION STANDARDS

- a. Retain the network of streets and alleys as public circulation space and for maximum public access. See also the discussion of historic circulation patterns on page 0-13 in the introduction.
 - b. Link a new street to existing public rights-of-way, when feasible.
2. Design new on-site pedestrian connections to enliven properties.
 - a. When establishing a service lane or a walkway that is internal to a site, situate it to express the location of circulation routes that existed historically (see the discussion of historic development patterns starting on page 0-6 of the Introduction for specific locations).
 - b. When a walkway internal to a site is planned, direct it through a plaza, courtyard or other outdoor use area to help animate the space.
 3. Site a building to complement historic circulation routes and view corridors.

B. Open Space

Surviving significant historic open spaces are essential elements in the Stockyards context and should be considered primary features for preservation. New open space designs should reinforce development patterns while providing compatible connections to the historic district.

1. Preserve historically significant open spaces.
 - a. Historically significant open spaces include the plaza in front of the Coliseum, the lawn in front of the Stock Exchange, Mule Alley, Rodeo Plaza and the Swift/Armour Stairs.
 - b. Other open spaces that existed historically should be restored, to the extent feasible. Opportunities to re-establish historic open space include:
 - i. The Armour Administration Site (Item "K" on 1927 Stockyards Sanborn Map, page 0-10 of the introduction)
 - ii. The semi-circular lawn that existed on East Exchange Avenue.



Provide internal connections for pedestrians when possible.



Strategically locate public spaces on a site to maintain key views or frame views as perceived from the public right-of-way.

2. Locate a new open space to provide views of historic buildings and street-scapes.
 - a. Strategically locate open space to maintain key views or frame views as they are perceived from the public right-of-way.
 - b. Locate open space along axes of historic circulation routes.
 - c. Locate an open space to minimize visual impacts on the historic street-scape.

C. Parking

Surface parking should be visually subordinate to other uses and compatible with nearby historic resources. Buffer areas should screen parking from the

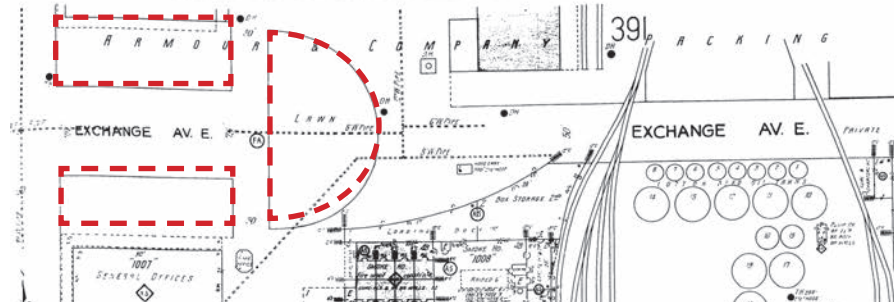

Opportunities to re-establish historic open space include the areas at the top of the Swift/Armour Stairs (shown here in dashed red lines, in 1927).



Incorporate historic brick paving in parking lots to maintain a reference to traditional paving designs.

street and public walkways as well as neighboring uses.



SEE DIV. 7.2 FOR PARKING LOT LANDSCAPING STANDARDS

1. Design a surface parking lot to be compatible with nearby historic resources.
 - a. Use materials that are compatible with nearby historic buildings.
 - b. Incorporate historic brick paving to maintain a reference to traditional paving designs.
 - c. Appropriate screening methods in an HCO- district include:
 - i. A low site wall that is similar in materials and appearance to the primary structure, such as masonry.
 - ii. A fence that uses wood framing and metal gusset-style construction that references historic cattle pens.
 - iii. A landscape buffer of trees, shrubs and ground cover.

D. Sidewalks, Curbs and Gutters

Historic sidewalks, walkways, curbs and gutters are key features of the historic district, and should be maintained. If necessary, such features should be replaced in-kind or with a compatible substitute. New sidewalks and related features should be designed to be compatible with the character of the Historic District.



SEE ARTICLE 8 FOR STREET DIMENSIONAL STANDARDS

1. Preserve historic sidewalks, curbs and gutters.
 - a. Retain and maintain historic sidewalks, curbs and gutters to preserve the distinctive historic features of the streetscape.
 - b. Maintain a historic walkway leading from a sidewalk to a main building entry.
2. Install compatible replacement sidewalks, curbs or gutters if necessary.
 - a. Replace deteriorated sidewalks, curbs and gutters that are of historic significance in-kind, using physical evidence to guide the work.
 - b. Replace deteriorated sidewalks, curbs and gutters with a compatible substitute material if in-kind replacement is not feasible.
 - c. Use traditional materials such as brick and concrete.



Historic paving materials, such as brick, should be preserved and maintained.



Adapt historic paving materials to new uses.



Reuse historic paving material to define outdoor use areas.



Maintain a historic walkway leading from the sidewalk to a main building entry.



Reuse historic features such as rails when possible, in plazas and courtyards.

E. Paving, Plazas and Seating Areas

Paving, plazas and seating areas play a vital role and should be thoughtfully designed while complementing historic precedent through materials, form and placement. New designs should appear of their own time while contributing to a sense of continuity for the Historic District.

1. Design new paving, plazas and seating areas to be compatible with the historic context.
 - a. In HSH-40 and HSH-68, use painted, ornamental features to complement the urban character.
 - b. In HCO-40 and HCO-68, use rustic site furnishings, wood framing with heavy steel gussets and brick paving to complement the "cowboy heritage".
 - c. In HCO-55, use a primarily "industrial" character, with site features constructed with metal and masonry materials.
2. Use decorative paving to define seating and courtyard areas.
 - a. Reuse historic brick paving and other site features such as rails when possible. Opportunities include:
 - i. Special use areas
 - ii. Accents to other paving materials
 - iii. Framing/Edges for seating or other hardscape areas
 - b. If historic material is not available, use a new compatible material that conveys a similar color, texture and finish.

F. Streetscape and Site Furnishings

Historic site features in the public realm are located throughout the historic district. They are important elements of the setting and should be retained whenever possible. An assessment of a site should occur to identify specific historic streetscape and site furnishings. New streetscape and site furnishings should be consistent in character with the Historic District as a whole and the specific sub-district.



SEE ARTICLE 8 FOR STREETScape DIMENSIONAL STANDARDS

1. Maintain historic site features in the public realm.
 - a. Preserve existing public steps, rails and bridges, for example.
 - b. Protect features from impacts associated with construction of other public improvements.
2. Preserve historic site features. These include:
 - a. Brick pavers
 - b. Livestock ramps and bridges
 - c. Railings and fences
 - d. Entry gates and columns
 - e. Rails (train tracks)
 - f. Turnstiles
 - g. Cattle pen

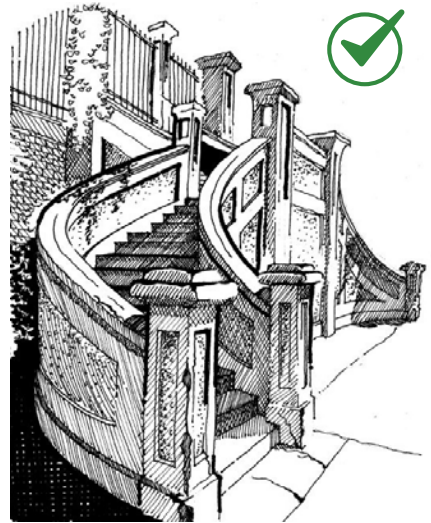

Preserve existing public steps, rails, and bridges.



This turnstile is an example of a historic site feature to preserve.



This historic Fort Worth Stockyards Gateway is a site feature that should be preserved.

3. Coordinate streetscape elements with neighboring properties along the street.
 - a. Consider the design context when determining sidewalk improvements.
 - b. Locate furnishings near heavily used pedestrian areas, such as key pedestrian routes, building entrances and outdoor gathering places.
 - c. Design street furnishings to be durable.
 - d. Locate street furnishings so they do not impede a primary pedestrian way.
 - e. Scale street lighting for pedestrians, where applicable.
4. Complement the historic character and materials of the historic context in the design of new streetscape elements and site furnishings.
 - a. In HSH-40 and HSH-60, draw from traditional designs and materials for a new site element that convey a "Main Street" character, such as:
 - i. Flat canopies with chain or cable and turnbuckle supports; and
 - ii. Wood framing.
 - b. In HCO-40 and HCO-68, draw from traditional designs and materials for a new site element that convey a "cowboy" character, such as:
 - i. Flat canopies with chain or cable and turnbuckle supports;
 - ii. Wood framing with heavy metal gusset plates;
 - iii. Clerestories; and
 - iv. Brick paving patterns.
 - c. In HCO-55, draw from traditional designs and materials for a new site element that convey an "industrial" character, such as:
 - i. Exposed steel supports;
 - ii. Concrete foundations; and
 - iii. Brick paving patterns.

G. Fences and Site walls

Historic fences and site walls survive in some parts of the historic district. Unpainted wood is the most common historic fence material. Brick and stone are the most common historic wall materials. These are important features that should be preserved. If necessary, such features should be replaced in-kind or with a compatible substitute. New fences and site walls may also be appropriate if they are compatible with the historic property and surrounding historic context.



SEE SEC. 7.2.4 FOR WALL AND FENCE STANDARDS

1. Preserve historic fences and site walls.
 - a. Maintain historic wooden and pipe rail fences.
 - b. Maintain historic brick, stone and concrete masonry site walls.
2. Design a new fence or site wall to be compatible with the historic property and surrounding historic context.
 - a. Design a new site wall with brick or concrete.
 - b. See the “Historic Framework” for precedents starting on page 0-6 in the introduction.

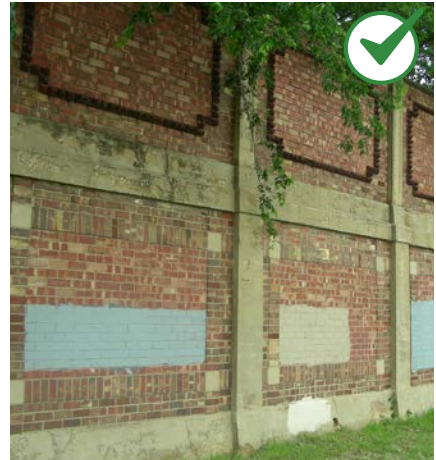



Maintain historic brick, stone and concrete masonry site walls.



A painted picket fence is out of character.

Historic Fences

Preserve historic corrals and pens and consider these precedents in designing new site features.



Coordinate landscape elements with neighboring properties and any existing natural area.

H. Trees and Plantings

Specimen trees (those that are particularly impressive or unusual examples of a species due to its size, shape, age or other traits), healthy mature trees and historic plantings are important parts of the context. Appraising these features as contributors to the setting will help in determining their significance. They should be retained whenever possible. When planting new trees, native and adapted species that are commonly seen in the surrounding historic context should be selected.



SEE DIV. 7.2 FOR LANDSCAPING STANDARDS

1. Maintain specimen trees and historic plantings.
 - a. Preserve existing historic plantings and yards.
 - b. Do not remove specimen trees or mature trees unless the tree is dying, dead, diseased or poses a safety hazard.
 - c. Protect specimen trees and healthy mature trees from impacts associated with new construction occurring near or within the drip line.
 - d. In some cases, the plant materials themselves may not have historic significance, but their location may have historic significance.
2. Introduce new trees and plantings that are compatible with the historic landscape and setting.
 - a. Continue the tradition of landscape planting along structural elements such as foundations, walkways and fences or walls.
 - b. Avoid planting too close to a structure so as not to damage, or retain moisture against, architectural features or building foundations.
3. Coordinate landscape elements with neighboring properties and any existing natural area.
 - a. Retain existing mature landscape features that provide shade and protection from wind, and replace when necessary.
 - b. Where possible, use plant species that are native to the region.
 - c. Avoid species that require significant maintenance and care.
 - d. When adding new landscape features, consider ecological and aesthetic impacts to Marine Creek, if adjacent to the area.

ARTICLE 3. TRANSITION DISTRICT

| | |
|---|------|
| Div. 3.1. Description..... | 3-2 |
| Div. 3.2. Transition Sub-Districts..... | 3-3 |
| Sec. 3.2.1. Marine Creek (SY-TMC) | 3-4 |
| Sec. 3.2.2. North Forty (SY-TNF) | 3-6 |
| Sec. 3.2.3. Neighborhood Mixed Use (SY-TNX) | 3-8 |
| Sec. 3.2.4. Northern Edge (SY-TNE) | 3-10 |
| Sec. 3.2.5. Swift/Armour (SY-TSA) | 3-12 |
| Div. 3.3. Frontages..... | 3-14 |
| Sec. 3.3.1. Pedestrian | 3-15 |
| Sec. 3.3.2. General | 3-15 |
| Sec. 3.3.3. Marine Creek | 3-16 |
| Sec. 3.3.4. Pathway | 3-16 |
| Sec. 3.3.5. Heritage Tree Lawn | 3-17 |
| Sec. 3.3.6. Historic Wall | 3-17 |
| Div. 3.4. Design Guidelines..... | 3-19 |
| Sec. 3.4.1. Marine Creek (SY-TMC) | 3-19 |
| Sec. 3.4.2. North Forty (SY-TNF) | 3-20 |
| Sec. 3.4.3. Neighborhood Mixed Use (SY-TNX) | 3-22 |
| Sec. 3.4.4. Northern Edge (SY-TNE) | 3-24 |
| Sec. 3.4.5. Swift Armour (SY-TSA) | 3-26 |
| Sec. 3.4.6. Site Design | 3-28 |
| Sec. 3.4.7. Building Design | 3-34 |

Div. 3.1. Description

The Transition Districts are intended to provide a transition in scale and character to non-historic areas of the Stockyards. The objective is to promote development that is compatible with the Historic District along its edge, while permitting a transition to buildings of larger scale farther away from the Historic District. Development also is intended to be influenced by the design traditions of the Historic District, in terms of form, materials and character, but in more abstract ways than within the Historic District itself.

The intent is to promote best practices in urban design, by establishing a more pedestrian and bike friendly environment and to enhance connectivity within properties and to the other parts of the stockyards area. Streets should be designed to be active and visually engaging at the sidewalk edge.

The Transition District includes the following sub- districts:*

1. SY-TMC: Marine Creek-68
2. SY-TNF: North Forty-40, -55
3. SY-TNX: Neighborhood Mixed Use-55, -80
4. SY-TNE: Northern Edge-68, -105
5. SY-TSA: Swift/Armour-55, -80, -205, -130

*The number represents the maximum height allowed in feet for that sub-district.

This Article includes development standards ([Div. 3.2](#) and [Div. 3.3](#)) that are mandatory and apply to all properties throughout the Transition District.

This Article also includes design guidelines ([Div. 3.4](#)). The design guidelines are intended to work in concert with the development standards to promote compatible development adjacent to the Historic District as well as high quality development and best practices in urban design. They are provided as advisory information, except where a project seeks a major modification from the Urban Design Commission, in which case compliance is required.



Div. 3.2. Transition Sub-Districts

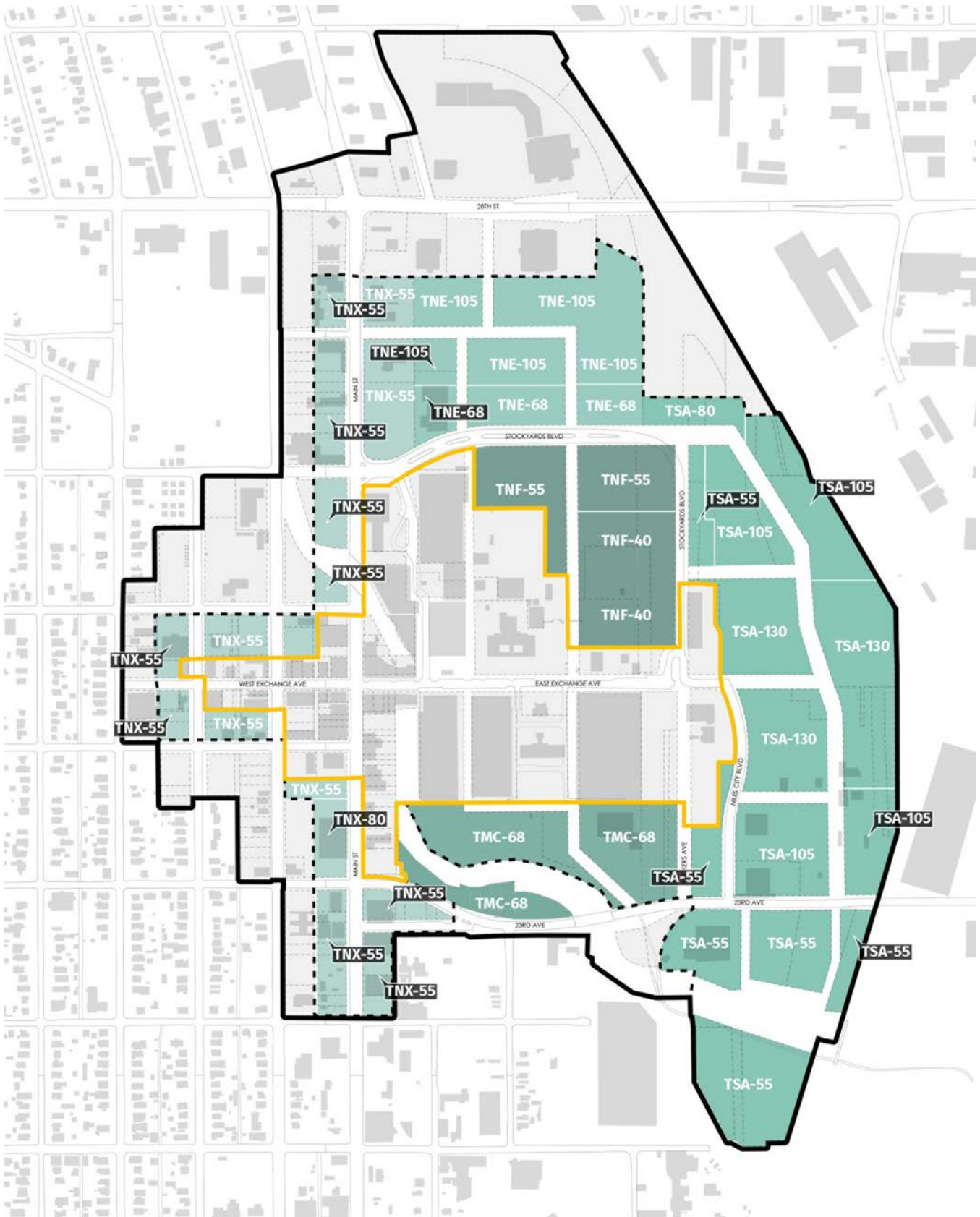

SEC. 3.2.1. MARINE CREEK (SY-TMC)



Intent

The Transition Marine Creek (SY-TMC) District is intended to accommodate development that orients to and enhances the experience along the Creek and that is sensitive to the edge of the Historic District. This includes the potential to improve connections from the Stockyards to Downtown along the Trinity Trail. An objective, therefore, is to promote development that will enhance and orient to Saunders Park and celebrate the waterfront.

Applicable Districts

SY-TMC-68

Use

Allowed uses see [Div. 6.1](#)

A. BUILDING PLACEMENT

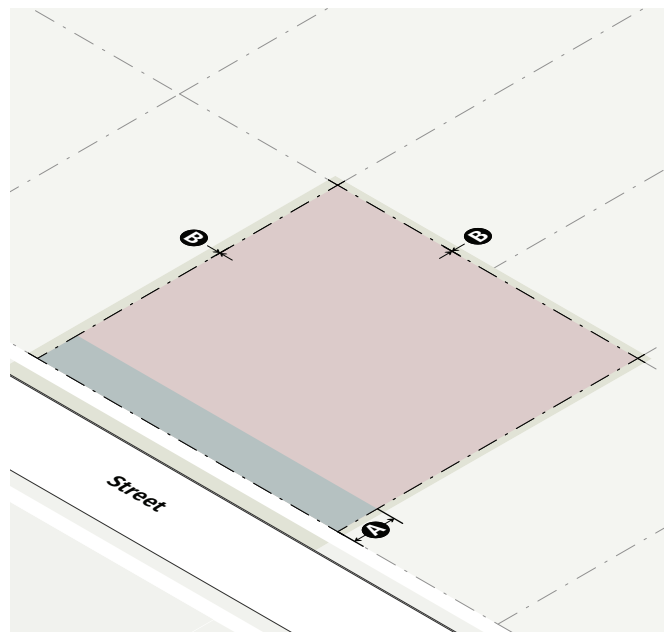

Lot

| | |
|-------|-----|
| Area | n/a |
| Width | n/a |

Building Setbacks

| | |
|--------------------------|--------------|
| A Front | see Frontage |
| B Common lot line | 0' min |
| Alley | 5' min |

B. BULK AND MASS

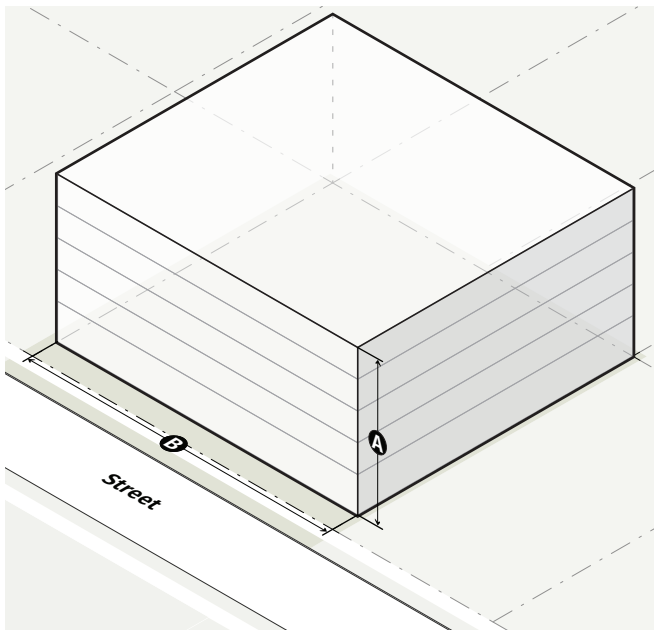

Building Height

| | |
|-------------------------|---------|
| A Maximum height | 68' max |
| Minimum height | n/a |

Roof Form see [Sec. 5.2.1](#)

| | |
|---------------------|-------------|
| Flat | Allowed |
| Traditional parapet | Allowed |
| Barrel vault | Not allowed |
| Gable: medium pitch | Allowed |
| Gable: steep pitch | Not allowed |
| Hipped | Allowed |

Building Form see [Sec. 5.2.2](#)

| | |
|--|-------------|
| B Creek/street-facing building length | 200' max |
| Rectilinear building | Required |
| Angled, curved building | Not allowed |

Articulation see [Sec. 5.2.3](#)

C. FRONTAGE

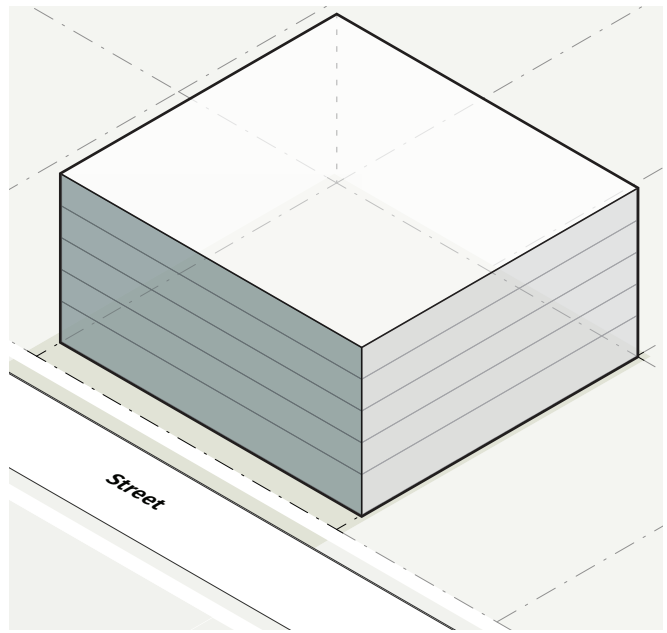

Applicable Frontages

see [Div. 3.3](#)

| | |
|--------------------|----|
| Pedestrian | -- |
| General | ◇ |
| Marine Creek | ◇ |
| Pathway | -- |
| Heritage Tree Lawn | ◇ |
| Historic Wall | -- |

Building Materials

see [Sec. 5.2.4](#)

SEC. 3.2.2. NORTH FORTY (SY-TNF)



Intent

The Transition North Forty (SY-TNF) District is intended to accommodate new, mixed use development, facilitate continuing use of livestock activities and maintain opportunities for the public to experience handling of livestock in the area. Historically, this area was an active part of the Stockyards, with many pens and cattle run, but few historic features remain. As the area redevelops, an objective is to retain and reuse surviving historic features that will help to recall the historic uses, while accommodating compatible new development. This may include brick paving materials, cattle pens, and related artifacts. Reflecting portions of the grid system that originally existed here, in terms of circulation routes and view corridors, is also an objective. Buildings should be located such that views to historic buildings along Exchange Avenue are maintained.

Applicable Districts

SY-TNF-40, SY-TNF-55

Use

Allowed uses see [Div. 6.1](#)

A. BUILDING PLACEMENT

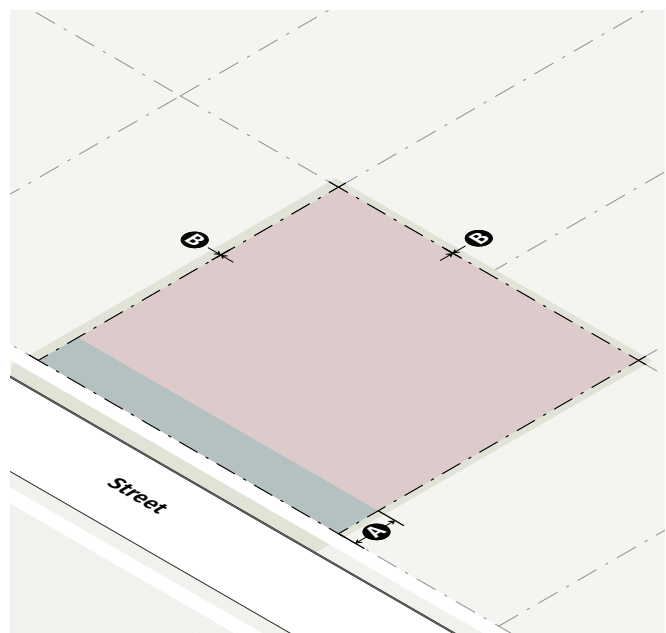

Lot

| | |
|-------|-----|
| Area | n/a |
| Width | n/a |

Building Setbacks

| | |
|--------------------------|--------------|
| A Front | see Frontage |
| B Common lot line | 0' min |
| Alley | 5' min |

B. BULK AND MASS

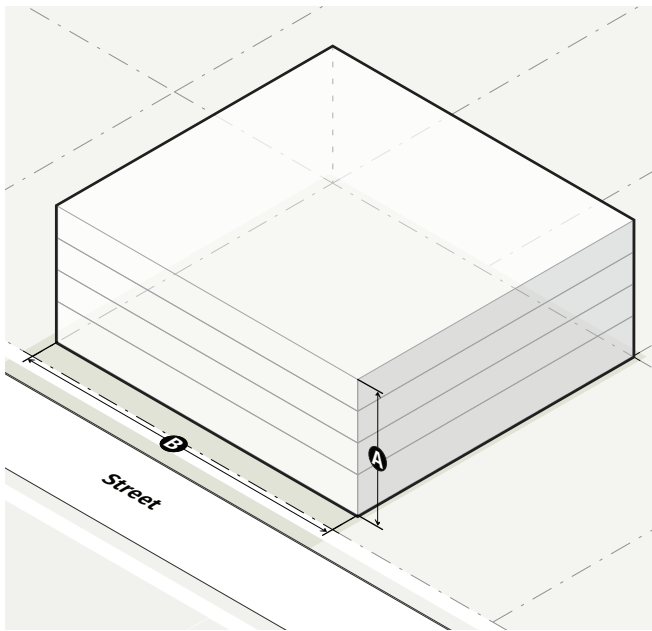

Building Height

| | |
|-------------------------|---------|
| A Maximum height | |
| SY-TNF-40 | 40' max |
| SY-TNF-55 | 55' max |
| Minimum height | n/a |

Roof Form see [Sec. 5.2.1](#)

| | |
|---------------------|-------------|
| Flat | Allowed |
| Traditional parapet | Allowed |
| Barrel vault | Not allowed |
| Gable: medium pitch | Allowed |
| Gable: steep pitch | Not allowed |
| Hipped | Allowed |

Building Form see [Sec. 5.2.2](#)

| | |
|--|-------------|
| B Street-facing building length | 250' max |
| Rectilinear building | Required |
| Angled, curved building | Not allowed |

Articulation see [Sec. 5.2.3](#)

C. FRONTAGE

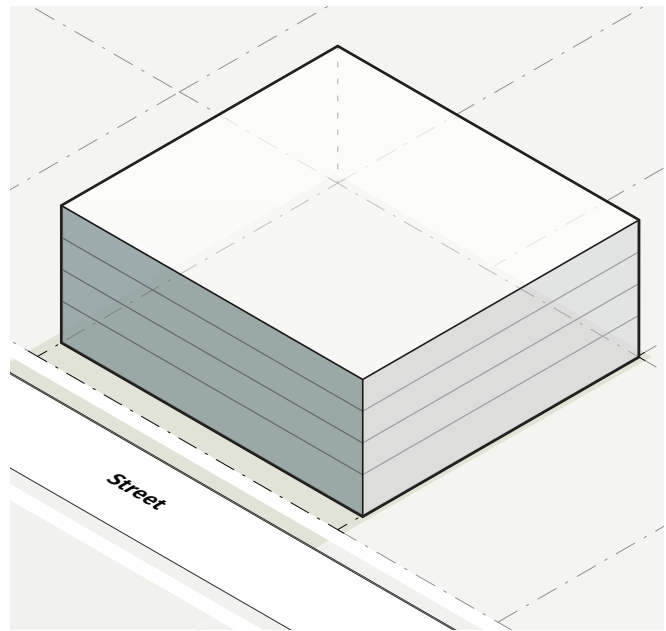

Applicable Frontages

see [Div. 3.3](#)

| | |
|--------------------|----|
| Pedestrian | -- |
| General | ◇ |
| Marine Creek | -- |
| Pathway | ◇ |
| Heritage Tree Lawn | ◇ |
| Historic Wall | -- |

Building Materials

see [Sec. 5.2.4](#)

SEC. 3.2.3. NEIGHBORHOOD MIXED USE (SY-TNX)

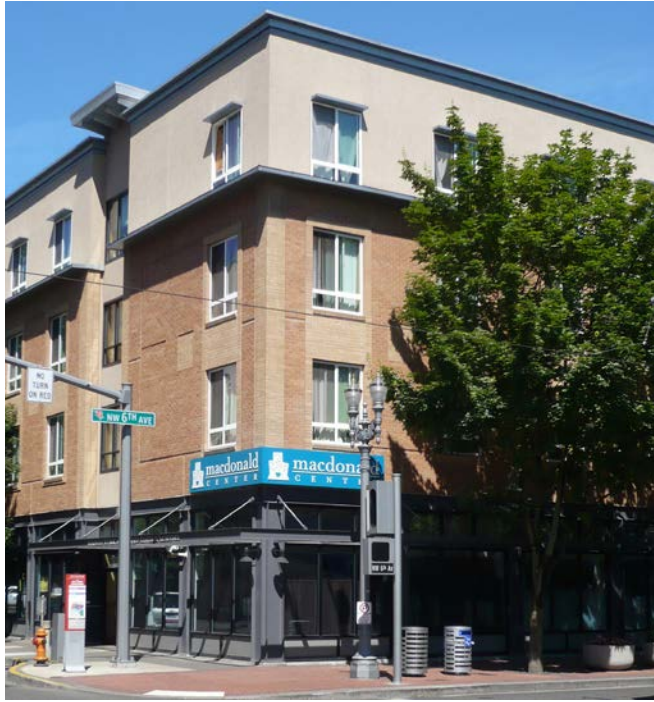

Intent

The Transition Neighborhood Mixed Use (SY-TNX) District is intended to frame the edges of the Historic District along Main Street and West Exchange Avenue. The intent is to serve as a transition, in terms of building form, mass and scale, from the clearly defined context of the Historic District to the abutting neighborhoods and to provide for uses that support the Stockyards activities and serve visitors and residents in the area. The SY-TNX District is intended to accommodate a variety of building types, including shopfronts, mixed use buildings and apartments. Enhancing these areas as places for pedestrian activity is a goal and an objective is to activate the street with shopfronts and other street wall treatments to provide visual interest. A greater variety of building forms and materials is available in this area as well.

Applicable Districts

SY-TNX-55, SY-TNX-80

Use

Allowed uses see [Div. 6.1](#)

A. BUILDING PLACEMENT

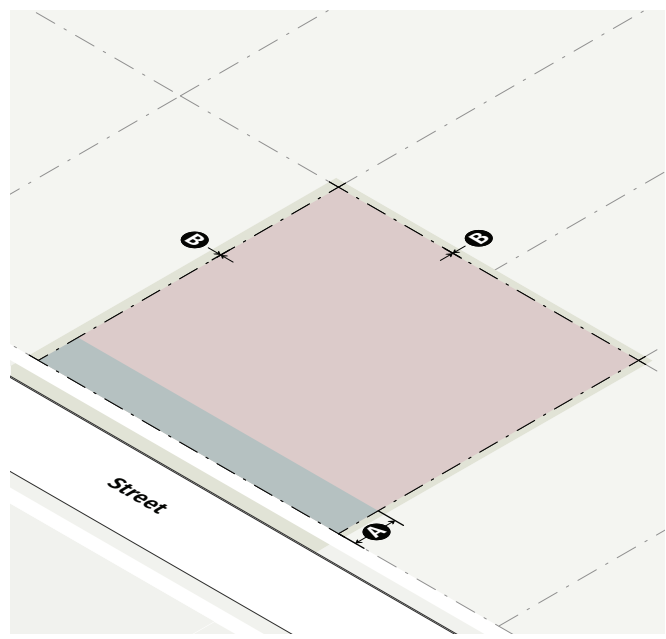

Lot

| | |
|-------|-----|
| Area | n/a |
| Width | n/a |

Building Setbacks

| | |
|--------------------------|--------------|
| A Front | see Frontage |
| B Common lot line | 0' min |
| Alley | 5' min |

B. BULK AND MASS

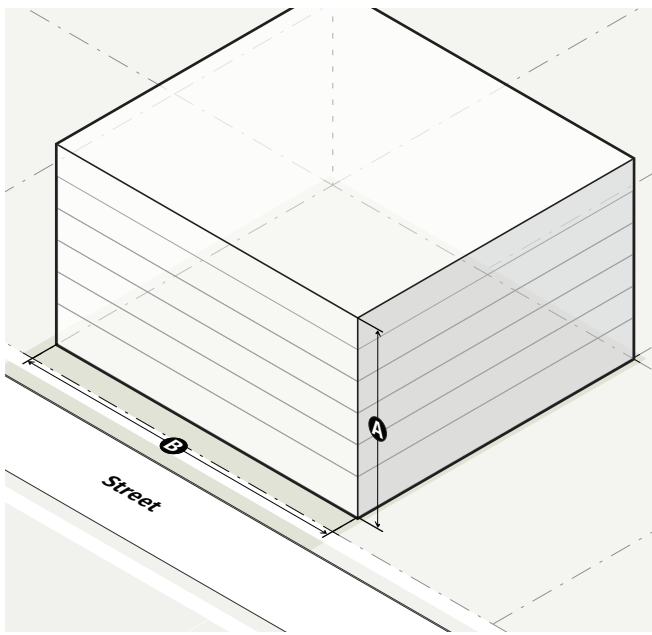

Building Height

| | |
|--|--------------------------------|
| A Maximum height | |
| SY-TNX-55 | 55' max |
| SY-TNX-80 | 80' max |
| B Minimum height | 2 stories of occupiable space |
| Roof Form | see Sec. 5.2.1 |
| Flat | Allowed |
| Traditional parapet | Allowed |
| Barrel vault | Not allowed |
| Gable: medium pitch | Allowed |
| Gable: steep pitch | Not allowed |
| Hipped | Allowed |
| Building Form | see Sec. 5.2.2 |
| C Street-facing building length | 150' max |
| Rectilinear building | Required |
| Angled, curved building | Not allowed |
| Articulation | see Sec. 5.2.3 |

C. FRONTAGE

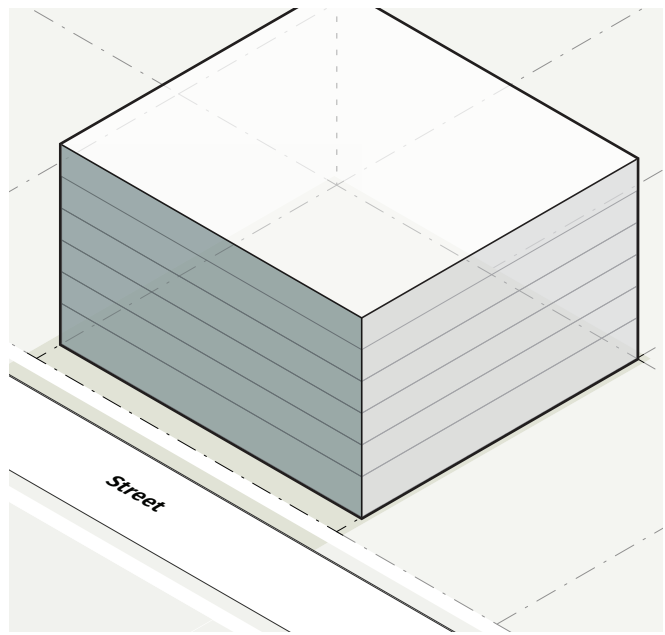

Applicable Frontages

see [Div. 3.3](#)

| | |
|--------------------|----|
| Pedestrian | ◇ |
| General | ◇ |
| Marine Creek | -- |
| Pathway | -- |
| Heritage Tree Lawn | -- |
| Historic Wall | -- |

Building Materials

see [Sec. 5.2.4](#)

SEC. 3.2.4. NORTHERN EDGE (SY-TNE)



Intent

The Transition Northern Edge (SY-TNE) District is intended to promote best practices in urban design, by establishing a more pedestrian and bike friendly environment and to enhance connectivity within properties and to the other parts of the Stockyards area. Much of the area provides opportunities for views of the Historic District and to Downtown, which should be considered in the location and orientation of new buildings. While this area was historically associated with the Stockyards, little evidence of this fact remains. New development is anticipated here and will be less influenced by historic precedents. Therefore, greater variety in building form and materials is appropriate in this district. An objective of the SY-TNE District is to provide services that support the overall Stockyards area and adjacent neighborhoods. This may include retail shopfronts, hotels, offices and residential uses.

Applicable Districts

SY-TNE-68, SY-TNE-105

Use

Allowed uses see [Div. 6.1](#)

A. BUILDING PLACEMENT

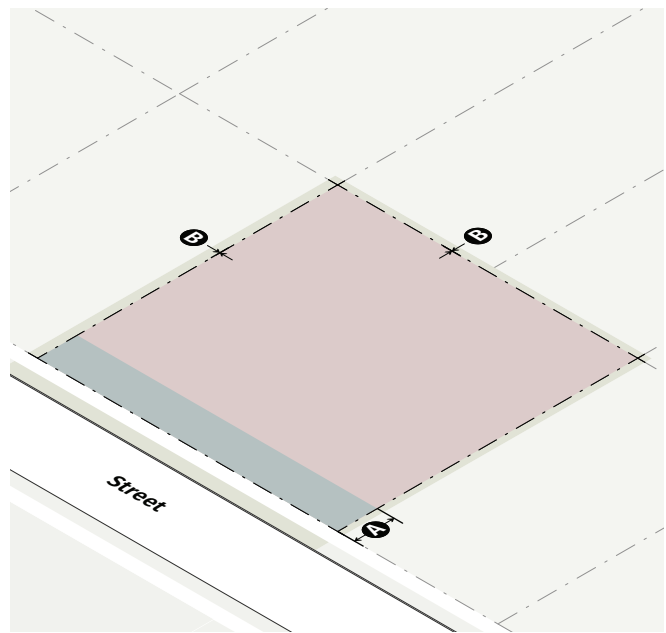

Lot

| | |
|-------|-----|
| Area | n/a |
| Width | n/a |

Building Setbacks

| | |
|--------------------------|--------------|
| A Front | see Frontage |
| B Common lot line | 0' min |
| Alley | 5' min |

B. BULK AND MASS

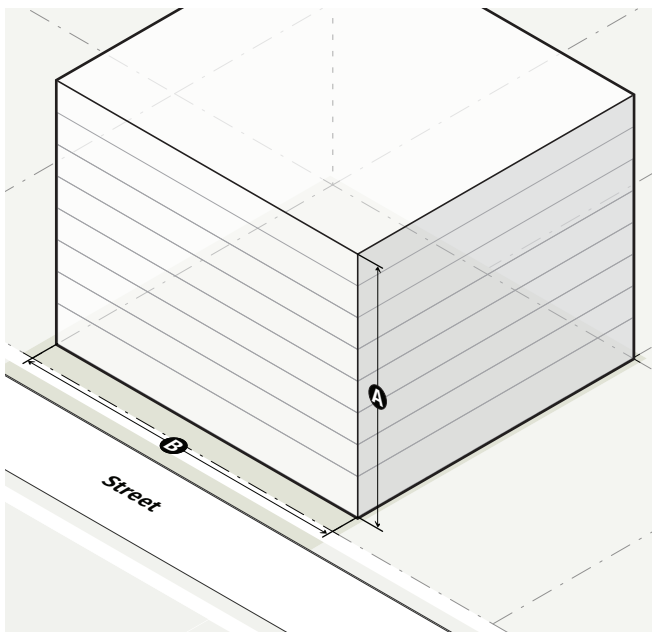

Building Height

| | |
|--|--------------------------------|
| A Maximum height | |
| SY-TNE-68 | 68' max |
| SY-TNE-105 | 105' max |
| B Minimum height | 2 stories of occupiable space |
| Roof Form | see Sec. 5.2.1 |
| Flat | Allowed |
| Traditional parapet | Allowed |
| Barrel vault | Allowed |
| Gable: medium pitch | Allowed |
| Gable: steep pitch | Not allowed |
| Hipped | Allowed |
| Building Form | see Sec. 5.2.2 |
| C Street-facing building length | 250' max |
| Rectilinear building | Allowed |
| Angled, curved building | Allowed |
| Articulation | see Sec. 5.2.3 |

C. FRONTAGE

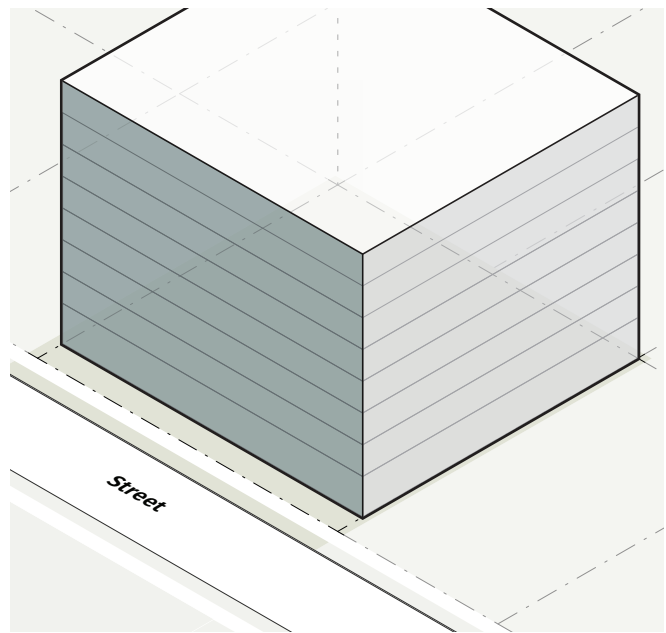

Applicable Frontages

see [Div. 3.3](#)

| | |
|--------------------|----|
| Pedestrian | -- |
| General | ◇ |
| Marine Creek | ◇ |
| Pathway | ◇ |
| Heritage Tree Lawn | -- |
| Historic Wall | -- |

Building Materials

see [Sec. 5.2.4](#)

SEC. 3.2.5. SWIFT/ARMOUR (SY-TSA)

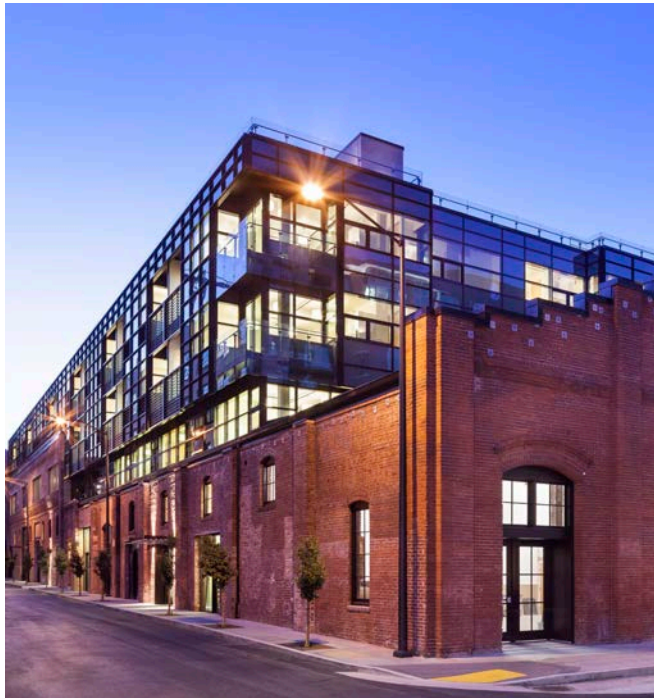

Intent

The Transition Swift/Armour (SY-TSA) District is intended to serve as a transition in scale and character from the Historic District while complementing the earlier scale and form of building in contemporary ways. An objective is to promote a mixed-use urban area with walkable streets and contextually sensitive buildings that adapt historic resources to new functions. Therefore, the SY-TSA District is intended to accommodate new development that reflects the general mass and scale of building that appeared here historically. For this reason, there is the potential for taller buildings and with larger footprints than in other parts of the Stockyards. Site design also is intended to draw upon historic precedents.

Applicable Districts

SY-TSA-55, SY-TSA-80, SY-TSA-105, SY-TSA-130

Use

Allowed uses see [Div. 6.1](#)

A. BUILDING PLACEMENT

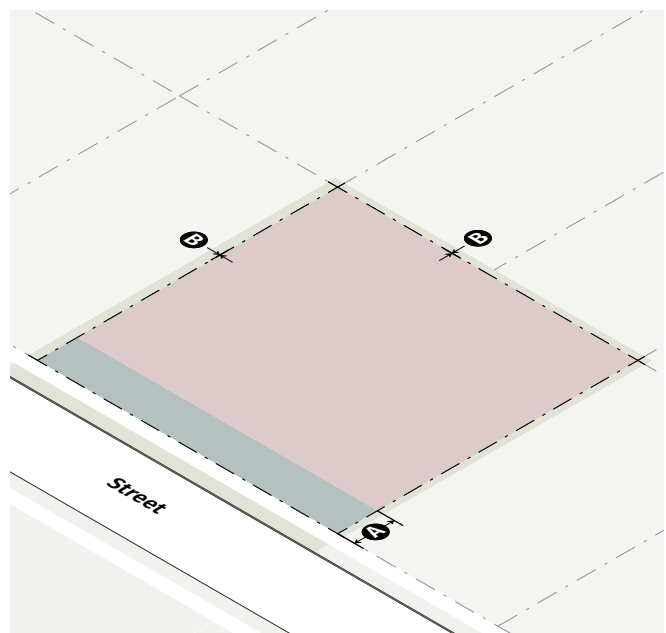

Lot

| | |
|-------|-----|
| Area | n/a |
| Width | n/a |

Building Setbacks

| | |
|--------------------------|--------------|
| A Front | see Frontage |
| B Common lot line | 0' min |
| Alley | 5' min |

B. BULK AND MASS

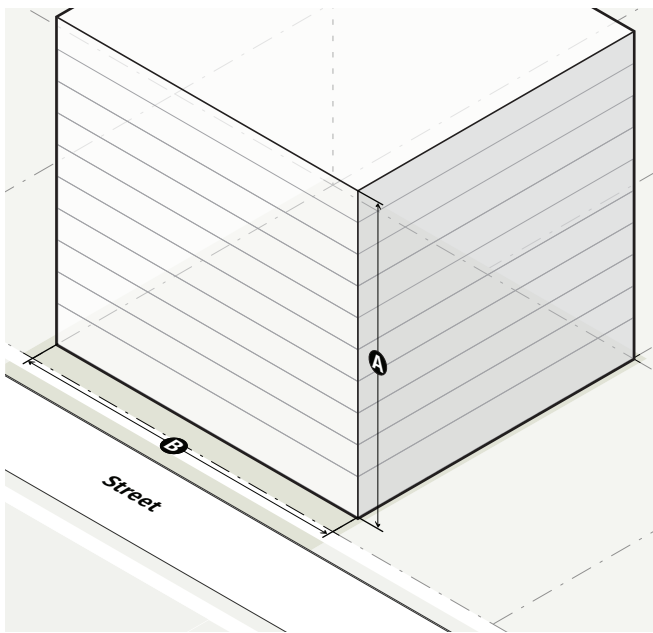

Building Height

| | |
|-------------------------|----------|
| A Maximum height | |
| SY-TSA-55 | 55' max |
| SY-TSA-80 | 80' max |
| SY-TSA-105 | 105' max |
| SY-TSA-130 | 130' max |

| | |
|-------------------------|-------------------------------|
| B Minimum height | 2 stories of occupiable space |
|-------------------------|-------------------------------|

Roof Form see [Sec. 5.2.1](#)

| | |
|---------------------|-------------|
| Flat | Allowed |
| Traditional parapet | Allowed |
| Barrel vault | Allowed |
| Gable: medium pitch | Allowed |
| Gable: steep pitch | Not allowed |
| Hipped | Allowed |

Building Form see [Sec. 5.2.2](#)

| | |
|--|----------|
| C Street-facing building length | 300' max |
| Rectilinear building | Allowed |
| Angled, curved building | Allowed |

Articulation see [Sec. 5.2.3](#)

C. FRONTAGE

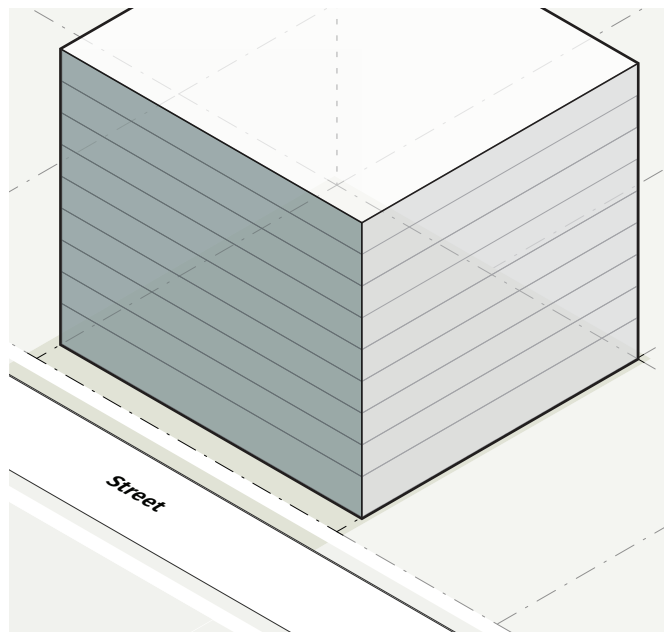

Applicable Frontages

see [Div. 3.3](#)

| | |
|--------------------|----|
| Pedestrian | ◇ |
| General | ◇ |
| Marine Creek | -- |
| Pathway | -- |
| Heritage Tree Lawn | -- |
| Historic Wall | ◇ |

Building Materials

see [Sec. 5.2.4](#)

Div. 3.3. Frontages

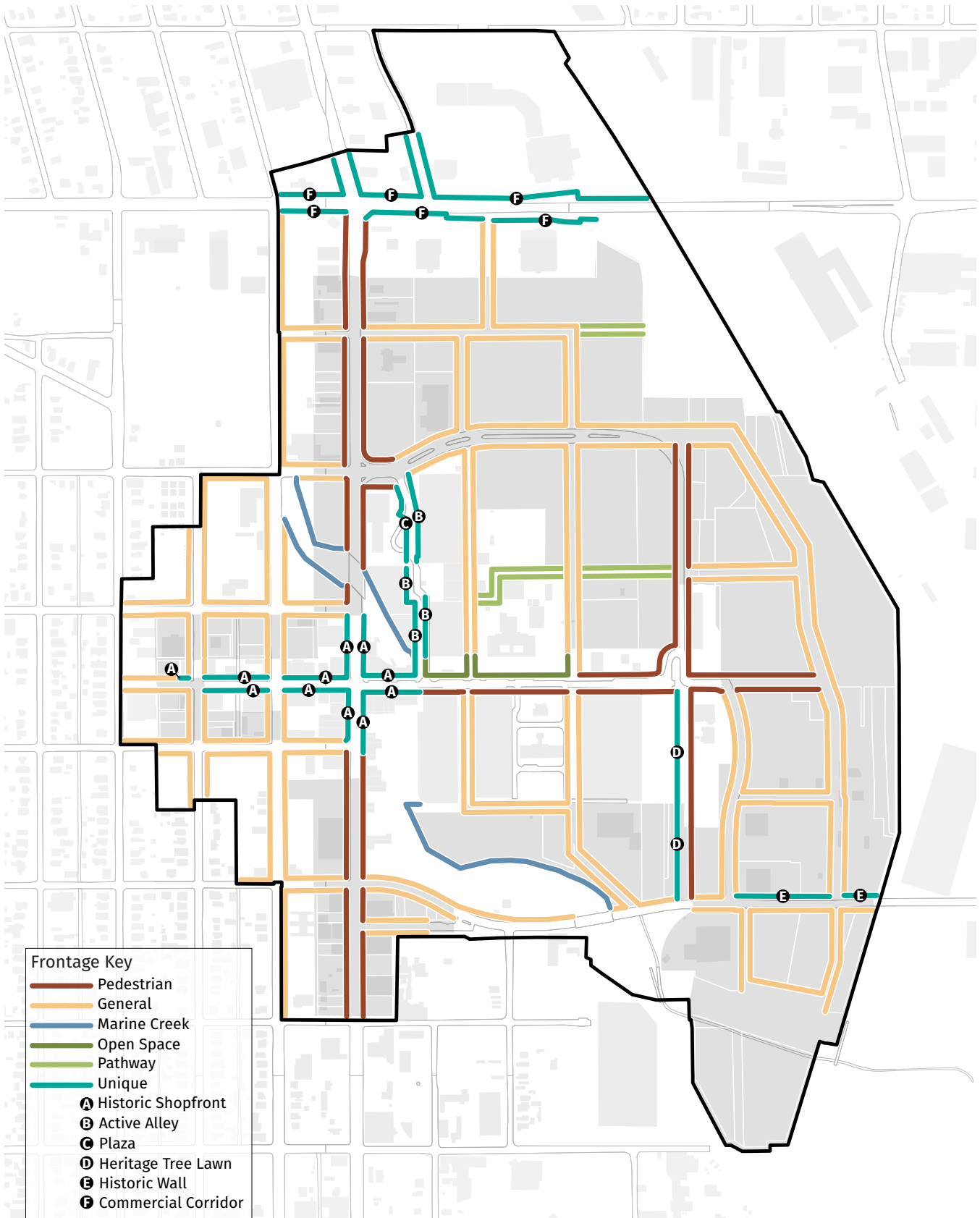

SEC. 3.3.1. PEDESTRIAN

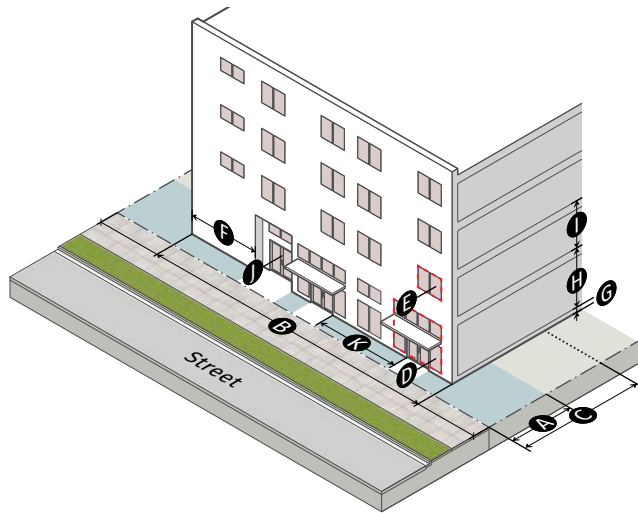

| Setbacks | |
|--|-------------------|
| A Build-to zone | 15' max |
| B % of building facade in build-to zone | 70% min |
| C Parking setback | 30' min |
| Transparency | |
| D Ground story | 60% min |
| E Upper story | 20% min |
| F Blank wall area | 25' max |
| Story Height | |
| G Ground floor elevation | 0' min/ 2' max |
| H Ground story | 13' min |
| I Upper story | 9' min |
| Pedestrian Access | |
| J Entrance facing street | Required |
| K Entrance spacing along street | 50' max |
| Building Elements | |
| | <u>Sec. 5.1.4</u> |
| Awning/canopy | ◇ |
| Balcony | ◇ |
| Forecourt | ◇ |
| Gallery | ◇ |
| Porch | -- |
| Stoop | -- |

SEC. 3.3.2. GENERAL

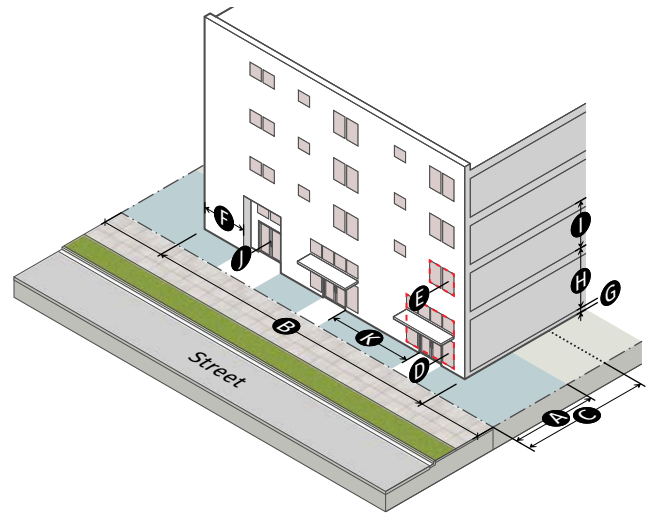

| | Nonresidential Ground Floor | Residential Ground Floor |
|--|--------------------------------|-----------------------------|
| Setbacks | | |
| A Build-to zone | 15' max | 15' max |
| B % of building facade in build-to zone | 60% min | 60% min |
| C Parking setback | 30' min | 30' min |
| Transparency | | |
| D Ground story | 40% min | 20% min |
| E Upper story | 20% min | 20% min |
| F Blank wall area | 35' max | 35' max |
| Story Height | | |
| G Ground floor elevation | 0' min/ 2' max | 2' min/ 5' max |
| H Ground story | 12' min | 12' min |
| I Upper story | 9' min | 9' min |
| Pedestrian Access | | |
| J Entrance facing street | Required | Required |
| K Entrance spacing along street | 75' max | 125' max |
| Building Elements | | |
| | <u>Sec. 5.1.4</u> | <u>Sec. 5.1.4</u> |
| Awning/canopy | ◇ | ◇ |
| Balcony | ◇ | ◇ |
| Forecourt | ◇ | ◇ |
| Gallery | ◇ | -- |
| Porch | -- | ◇ |
| Stoop | ◇ | ◇ |

SEC. 3.3.3. MARINE CREEK

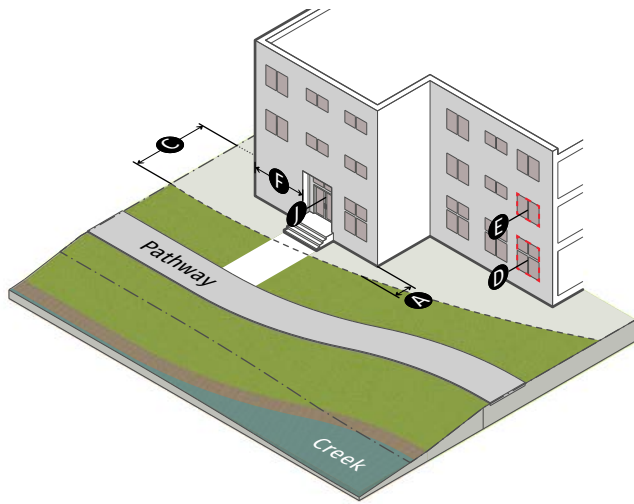

| Setbacks | | |
|-------------------|--|-------------------|
| A | Front (measured from the Marine Creek Floodway and Beautification Easement Line) | 0' min |
| B | % of building facade in build-to zone | n/a |
| C | Parking setback | 30' min |
| Transparency | | |
| D | Ground story | 20% min |
| E | Upper story | 20% min |
| F | Blank wall area | 50' max |
| Story Height | | |
| G | Ground floor elevation | n/a |
| H | Ground story | n/a |
| I | Upper story | n/a |
| Pedestrian Access | | |
| J | Entrance facing Creek | Required |
| K | Entrance spacing along Creek | n/a |
| Building Elements | | <u>Sec. 5.1.4</u> |
| | Awning/canopy | ◇ |
| | Balcony | ◇ |
| | Forecourt | ◇ |
| | Gallery | ◇ |
| | Porch | ◇ |
| | Stoop | ◇ |

SEC. 3.3.4. PATHWAY

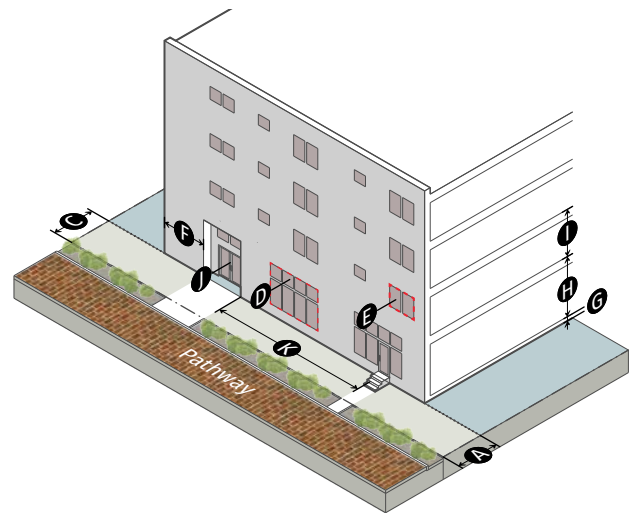

| | Nonresidential Ground Floor | Residential Ground Floor |
|-------------------|-----------------------------|--------------------------|
| Setbacks | | |
| A | 5' min | 5' min |
| B | n/a | n/a |
| C | 5' min | 5' min |
| Transparency | | |
| D | 50% min | 20% min |
| E | 20% min | 20% min |
| F | 30' max | 30' max |
| Story Height | | |
| G | 0' min/2' max | 2' min/5' max |
| H | 12' min | 12' min |
| I | 9' min | 9' min |
| Pedestrian Access | | |
| J | Required | Required |
| K | 100' max | 125' max |
| Building Elements | | <u>Sec. 5.1.4</u> |
| | Awning/canopy | ◇ |
| | Balcony | ◇ |
| | Forecourt | ◇ |
| | Gallery | ◇ |
| | Porch | -- |
| | Stoop | ◇ |

SEC. 3.3.5. HERITAGE TREE LAWN

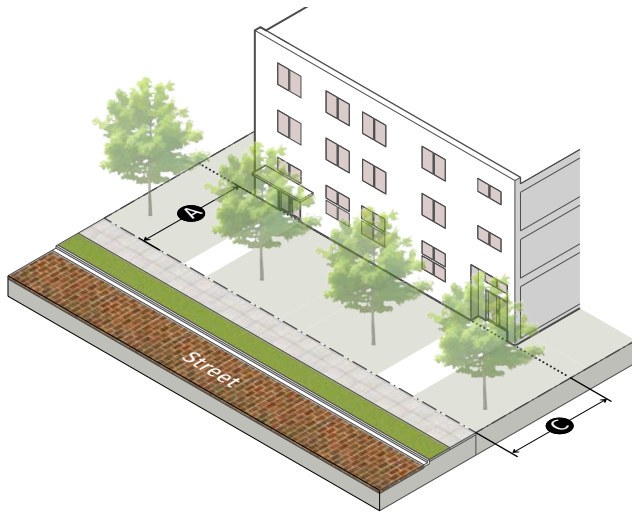

SEC. 3.3.6. HISTORIC WALL

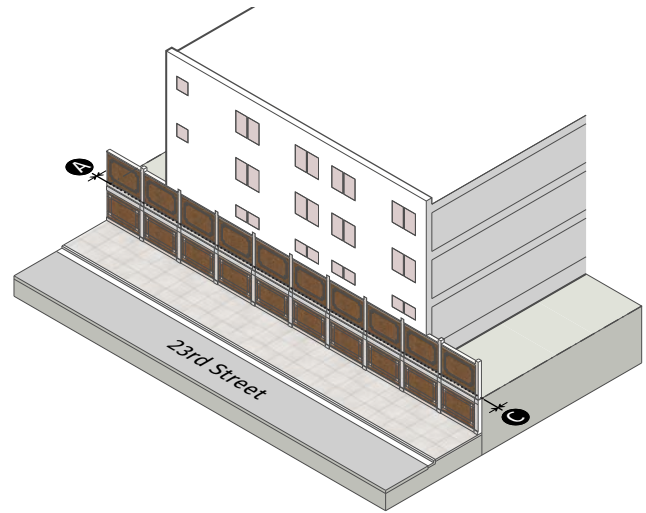

| Setbacks | |
|--|-------------------|
| A Front (min) | 30' min |
| B % of building facade in build-to zone | n/a |
| C Parking setback | 30' min |
| Transparency | |
| D Ground story | n/a |
| E Upper story | n/a |
| F Blank wall area | n/a |
| Story Height | |
| G Ground floor elevation | n/a |
| H Ground story | n/a |
| I Upper story | n/a |
| Pedestrian Access | |
| J Entrance facing street | n/a |
| K Entrance spacing along street | n/a |
| Building Elements | |
| | <u>Sec. 5.1.4</u> |
| Awning/canopy | ◇ |
| Balcony | ◇ |
| Forecourt | ◇ |
| Gallery | ◇ |
| Porch | ◇ |
| Stoop | ◇ |

| Setbacks | |
|--|-------------------|
| A Front | 0' min |
| B % of building facade in build-to zone | n/a |
| C Parking setback | 0' min |
| Transparency | |
| D Ground story | n/a |
| E Upper story | n/a |
| F Blank wall area | n/a |
| Story Height | |
| G Ground floor elevation | n/a |
| H Ground story | n/a |
| I Upper story | n/a |
| Pedestrian Access | |
| J Entrance facing street | n/a |
| K Entrance spacing along street | n/a |
| Building Elements | |
| | <u>Sec. 5.1.4</u> |
| Awning/canopy | -- |
| Balcony | ◇ |
| Forecourt | -- |
| Gallery | -- |
| Porch | -- |
| Stoop | -- |

Div. 3.4. Design Guidelines

This Division presents design guidelines for the Transition District. It includes a listing of key principles for each of the groupings of sub-districts ([Sec. 3.4.1](#) through [Sec. 3.4.5](#)), guidelines for site design ([Sec. 3.4.6](#)) and guidelines for building design ([Sec. 3.4.7](#)). Photographs and drawings included illustrate how design principles and guidelines should be exemplified in specific development projects.

SEC. 3.4.1. MARINE CREEK (SY-TMC)

KEY PRINCIPLES

- | | |
|---|--|
| <p>A. Development that is “double-fronted,” in that it orients to the Creek and to the periphery of the Historic District</p> <p>B. Structured parking that is compatible with the “two fronts,” of the Creek and periphery of the Historic District.</p> <p>C. Maintain the “axis” along Mule Alley to Marine Creek.</p> <p>D. Maintain the “axis” along the western edge of Stockyards Station.</p> | <p>E. Accommodate a potential pedestrian bridge with gateway elements, located along axis between the horse and mule barns.</p> <p>F. Accommodate animal exhibition uses, such as an open air warm-up ring, potentially south of Stockyards Station.</p> <p>G. Accommodate the opportunity for a water taxi connection to Downtown.</p> <p>H. Accommodate opportunities to celebrate the waterfront with public space.</p> |
|---|--|

CHARACTER IMAGERY

These images below illustrate the design guidelines and objectives for the Transition Marine Creek District.



- » Traditional flat roof form
- » Accented entry
- » Window alignment
- » Vertical articulation (wall offset)



- » Outdoor dining space
- » Traditional materials

SEC. 3.4.2. NORTH FORTY (SY-TNF)

KEY PRINCIPLES

- A. Accommodate livestock circulation.
- B. Accommodate options for trailer parking and linear park space along the stormwater pipe easement.
- C. Accommodate a pedestrian overpass to the Swift/Armour area in its original location.
- D. Preserve historic structures.
- E. Accommodate additional livestock and horse uses.
- F. Provide for retail opportunities along existing streets.
- G. Accommodate a new north-south connector street.
- H. Strategically locate structured parking to be subordinate to active public ways.
- I. Convey the historic pattern of pens and livestock runs in the location of walkways, streets, and open space.
- J. Orient new buildings to express the historic grid pattern.

CHARACTER IMAGERY

These images illustrate the design guidelines and objectives for the Transition North Forty District.



- » Base-middle-cap composition
- » Change in materials
- » Street front activation (stoops and entrances)
- » Traditional materials



- » Horizontal articulation (alignment of decorative moldings, window sills and balconies)
- » Vertical articulation (wall offsets)



- » Street level activation (shopfront)
- » Vertical articulation (wall offsets)
- » Horizontal articulation (alignment, etc.)



- » Street level activation (planter and entry)



- » Screened parking
- » Active use at street level
- » Clearly defined entry
- » Horizontal articulation (spandrels and fenestration)



- » Street level activation (shopfront)

SEC. 3.4.3. NEIGHBORHOOD MIXED USE (SY-TNX)

KEY PRINCIPLES

- A. Orient new buildings to express the historic grid organization.
- B. Maintain historic view corridors and circulation routes
- C. Transition in building scale when abutting the edge of the historic district.
- D. Activate the street level.
- E. Provide a sense of human scale and visual interest.

CHARACTER IMAGERY

These images illustrate the design guidelines and objectives for the Transition Neighborhood Mixed Use District. They include images that draw upon traditional shopfront designs, but with contemporary details. Building massing also is similar in scale to traditional commercial buildings in the area.



- » Street level activation (shopfront)
- » Masonry materials
- » Entry identification



- » Horizontal expression (fenestration patterns)
- » Vertical expression (wall offsets)



- » Parking screened
- » Active street level



- » Horizontal expression (fenestration patterns)
- » Vertical expression (wall offsets)



- » Street level activation (shopfront)
- » Masonry materials
- » Entry identification



- » Horizontal expression (upper floor stepback)
- » Fenestration patterns



- » Street level activation (shopfront)
- » Masonry materials
- » Entry identification



- » Rowhouses with stoops
- » Vertical expression (moldings & change in materials)



- » Vertical articulation
- » Horizontal expression



- » Street level activation (shopfront)
- » Masonry materials
- » Composition (base, middle & cap)



- » Street level activation (shopfront)
- » Masonry materials
- » Entry identification

SEC. 3.4.4. NORTHERN EDGE (SY-TNE)

KEY PRINCIPLES

- A. Establish a pedestrian-friendly street edge
- B. Provide a sense of human scale and visual interest in building design.
- C. Improve connectivity within and among parcels.
- D. Accommodate new north-south street connections from 28th to Stockyards Boulevard.
- E. Provide retail shopfront activity along Stockyards Boulevard.
- F. Accommodate opportunities to provide “double-fronted” buildings along the edge of the stormwater detention area as it becomes open space amenity.

CHARACTER IMAGERY

These images illustrate the design guidelines and objectives for the Transition Northern Edge District. These include more examples of residential uses, as well as commercial. They also include some that draw upon the historic use of wood framing, as it appeared in buildings and pens in this area.



- » Street level activation (shopfront)
- » Masonry materials
- » Composition (base, middle & cap)



- » Contemporary interpretation of wood framing of early stockyards buildings and pens



- » Variation in roof line
- » Wall offsets
- » Horizontal expression



- » Variation in roof line
- » Change in materials
- » Horizontal expression (balconies)



- » Horizontal articulation (spandrels and balconies)
- » Street level activation (balconies)



- » Horizontal articulation (change in materials)
- » Vertical articulation (wall offsets)



- » Variation in roof line
- » Wall offsets
- » Horizontal expression



- » Street level activation (shopfront)



- » Articulation (variation in roof form)
- » Masonry



- » Horizontal expression (stepdown in front)
- » Vertical expression

SEC. 3.4.5. SWIFT ARMOUR (SY-TSA)

KEY PRINCIPLES

- A. Preserve sight lines along the original rail spur locations.
- B. Re-create the central open space between the Swift and Armour sites.
- C. Where feasible, integrate existing buildings into new development.
- D. Create a system of urban streets and blocks with buildings fronting streets and open spaces.
- E. Draw from historic height and massing precedents.
- F. Buffer new uses from the adjacent active rail line.
- G. Provide compatible building heights along Packers Avenue as a transition to the historic district.

CHARACTER IMAGERY

These images illustrate the design guidelines and objectives for the Transition Swift/Armour District. These examples include some that have a more “industrial” character, in terms of materials, forms and detailing.



- » Vertical expression (change in materials)
- » Composition (base, middle & cap)



» Outdoor use area



» Vertical expression (change in materials, balconies & fenestration)



» Horizontal expression (change in materials & fenestration patterns)



» Composition (base, middle & cap)
» Vertical expression (wall offsets)



» Masonry materials
» Setback



» Vertical expression (wall offsets and change in materials)
» Horizontal expression (balconies and fenestration patterns)



» Street level activation (shopfront)
» Vertical expression



» Vertical expression (wall offsets and change in materials)



SEC. 3.4.6. SITE DESIGN

OBJECTIVES

Highlight Landscapes and Views

Properties should be planned to emphasize landscaped areas and frame important views. This includes retaining significant existing landscape features, when feasible, and planning development with abutting properties in mind, such that opportunities to plan in a coordinated manner are maximized. Planning view corridors such that they align with those on adjacent properties, and complement historic view and circulation patterns, is also encouraged.

Each Development Should Help to Build a Sense of Neighborhood

Projects should be planned to relate to adjoining properties in a positive way, by promoting connections, by planning cooperatively to make joint use of natural features that span across properties, and with designs that convey a sense of visual continuity.

Provide Positive Open Space

These include public and private spaces, promenades, plazas and courtyards. In addition, integrate and maintain natural resources for the public to experience with open space areas.

Provide Landscaping that Enhances Views from the Public Way

Landscaping should contribute to the visual continuity and delight of the area, while complementing the identities of individual sites.

Provide Landscaping that Enhances Pedestrian Activity Within a Site

Landscaping should help to define functional areas within the site, such as walkways and outdoor use areas. These places should be designed to facilitate their use throughout the year.

Keep Parking Subordinate

Parking lots should not dominate the setting. They should be visually buffered.

A. Views

Views from the public right-of-way to natural features also should be maintained. Significant views may occur from major public open spaces, street intersections, bridges and roadway overlooks.

1. Enhance views from the public right-of-way to scenic natural features and landmarks, when feasible.
 - a. Locate a building to maintain key views as they are seen from the public right-of-way.



Enhance views from the public right-of-way to scenic natural features and landmarks, when feasible.

B. Auto Connectivity

Connections to auto circulation systems on adjoining properties and within properties that permit access without returning to the street, should be provided, when feasible, to permit convenient access and to reduce traffic on abutting public streets.

1. Provide direct automobile access within or to an abutting property, when feasible.
 - a. Even where an adjoining parcel is presently undeveloped, reserve the opportunity to provide a connection in the future.

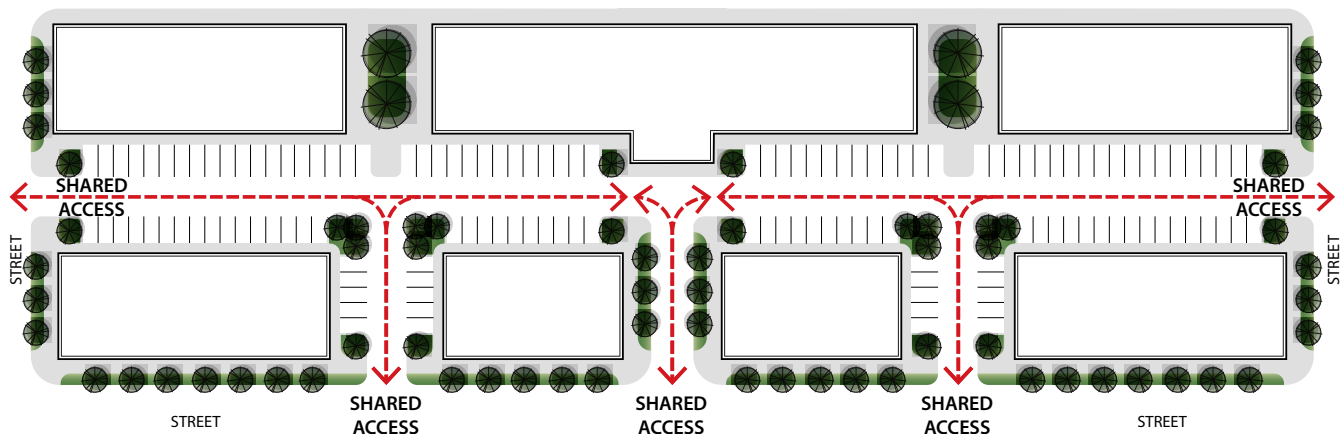

Use shared drives to access parking areas.



Provide convenient connections for pedestrians and bicyclists between buildings on an individual site.

C. Pedestrian and Bicycle Connectivity

Safe and convenient pedestrian and bicycle access should be provided to the regional trail system and among properties to achieve a sense of being an integrated neighborhood and to reduce dependence upon automobiles. In addition, the internal site circulation system should be coordinated.



SEE DIV. 8.2 FOR NEW CONNECTION STANDARDS

1. Provide convenient connections to regional and neighborhood pedestrian and bikeway circulation systems.
 - a. Provide connections to regional trails when they abut a property or are in close proximity.
 - b. Provide a clearly defined, direct connection from internal walkways to adjoining public sidewalks.
 - c. Provide convenient pedestrian and bikeway connections among abutting properties.

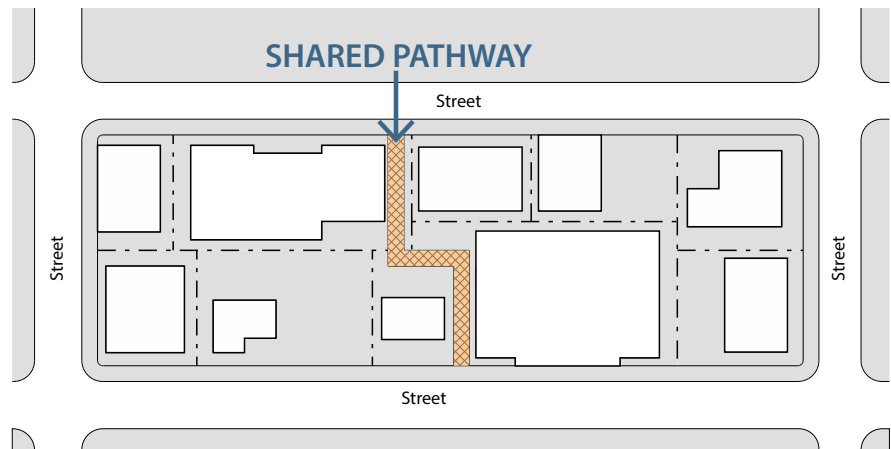

Provide convenient connections to regional and neighborhood pedestrian and bikeway circulation systems.

D. Open Space

The development of open space is encouraged in order to enhance a site as a place for pedestrians. Buildings and other site functions should be planned to create outdoor space that serve public, private, passive and active uses.

- 1. Develop open space for the site.
 - a. Define open space by clustering buildings in larger developments.
 - b. Position this space such that it can be shared by adjoining buildings, when feasible.
 - c. Consider orienting open space to views of activities, architectural landmarks or natural features to provide visual interest.
- 2. Provide public access and views to open space, when feasible.
 - a. Decorative surface materials and landscaping should be integrated as design features.
 - b. Reuse historic brick pavers whenever feasible.



The development of open space is encouraged in order to enhance a site as a place for pedestrians.



Reuse historic brick pavers whenever feasible.



Position outdoor space such that it can be shared by adjoining buildings, when feasible.

E. Landscape

Landscaped areas that can be enjoyed, both visually and functionally, should be provided in a project when feasible. Landscaped areas of an individual parcel should be coordinated with that of adjoining properties as well, such that mutual benefits can be maximized.



SEE DIV. 7.2 FOR LANDSCAPING STANDARDS

1. Coordinate landscaped areas with that of adjacent parcels such that they may be perceived as a larger area.
 - a. Also position landscaped areas to link access points with those of adjoining properties.
2. Organize uses to maximize natural assets of the site.
 - a. When a stormwater detention facility is to be provided, position it in green space and design it to be an amenity.
 - b. Locate a service area away from natural green space that is to be retained on the site.



Use a consistent plant palette throughout the property.



Landscaped areas that can be enjoyed, both visually and functionally, should be provided in a project when feasible.

F. Site Lighting

Site lighting should be designed to facilitate safe and convenient circulation of motorists, bicyclists and pedestrians. Light levels should be sufficient for safety. However, light spill onto adjacent properties and into the night sky should be minimized.



SEE DIV. 7.3 FOR SITE LIGHTING STANDARDS

1. Minimize the level of lighting across parking areas.
 - a. Focus higher light levels at key crossing points and intersections, rather than uniformly across a lot.
 - b. In other areas of a surface lot, provide a lower level of lighting, while also meeting safety needs.
2. Provide lighting for pedestrian ways that is appropriately scaled to walking.
 - a. Mount lights for pedestrian ways on short poles or consider using light posts (bollards).
3. Light fixtures should be in character with the setting.
 - a. Fixtures should be compatible with architectural and site design elements.



Provide lighting for pedestrians that is appropriately scaled to walking.

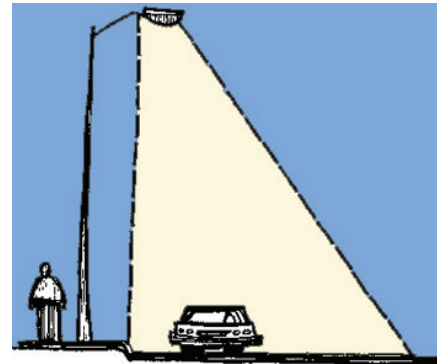

Lighting should be shielded to prevent off-site glare.

G. Service Areas

Service areas should be visually unobtrusive and should be integrated with the design of the site and associated buildings.



SEE SEC. 7.2.3 FOR SCREENING STANDARDS

1. Minimize the visual impacts of service areas.
 - a. Orient a service entrance, waste disposal area or other similar use toward service lanes and away from major streets.
 - b. Screen service entrances with walls or plantings.
 - c. When it will be visible from a public way, a service area screen should be in character with the building and site it serves.



Minimize the visual impacts of service areas.



Buildings should complement the design traditions of the Stockyards area, in terms of building and roof forms, scale, materials and other design elements.



Buildings in the commercial corridors should convey a high quality of design, in terms of their materials and details, as well as through a consistent organization of forms and elements.



Enhance the pedestrian experience. Each improvement project should contribute to a pedestrian-friendly environment.

SEC. 3.4.7. BUILDING DESIGN

OBJECTIVES

Complement the Design Traditions of the Stockyards Area

Buildings should complement the design traditions of the Stockyards area, in terms of building and roof forms, scale, materials and other design elements. Flat roofs with varied parapet lines and cornices are a key part of this tradition. Rectilinear building forms are the primary building form and should be provided.

Buildings that appear to be in scale with those seen traditionally also should be encouraged. Where a new building would be larger than those existing in the area, it should establish a transition in scale, to reduce the impact of building scale on the adjacent property, as well as on the neighborhood.

Achieve High Quality Design

Buildings in the commercial corridors should convey a high quality of design, in terms of their materials and details, as well as through a consistent organization of forms and elements. This quality should establish a standard for design throughout the community.

Design for Durability

Buildings should be designed for the long term with durable materials.

Enhance the Pedestrian Experience

Each improvement project should contribute to a pedestrian-friendly environment. This includes defining the street edges and walkways with buildings and spaces that are visually interesting that attract pedestrian activity.

A. Building Character

A new building should complement the design precedents of the Stockyards area while expressing its own time.

- 1. Innovative new designs that draw upon regional design traditions are preferred.
 - a. Design a building to provide a sense of authenticity in building and material.
 - b. Standardized “franchise” style architecture is discouraged.
- 2. The exact imitation of historic styles is inappropriate for new construction.
 - a. Contemporary interpretations of historic building forms, massing, materials and details that occurred traditionally in the form district are appropriate.



Design a building to provide a sense of authenticity in building and material.



Innovative new designs that draw upon regional design traditions are preferred. These example buildings incorporate timber framing that resembles the construction of the pen areas in the Stockyards.

ARTICLE 4. EDGE DISTRICT

| | |
|---|------|
| Div. 4.1. Description..... | 4-2 |
| Div. 4.2. Edge Sub-Districts | 4-3 |
| Sec. 4.2.1. Neighborhood Mixed Use (SY-ENX) | 4-4 |
| Sec. 4.2.2. Commercial Corridor (SY-ECC) | 4-6 |
| Div. 4.3. Frontages | 4-8 |
| Sec. 4.3.1. Pedestrian | 4-9 |
| Sec. 4.3.2. General | 4-9 |
| Sec. 4.3.3. Marine Creek | 4-10 |
| Sec. 4.3.4. Commercial Corridor | 4-11 |
| Div. 4.4. Design Guidelines..... | 4-12 |
| Sec. 4.4.1. Neighborhood Mixed Use (SY-ENX) | 4-12 |
| Sec. 4.4.2. Commercial Corridor (SY-ECC) | 4-14 |
| Sec. 4.4.3. Site Design | 4-16 |
| Sec. 4.4.4. Building Design | 4-22 |

Div. 4.1. Description

The Edge District is the area most removed from the Historic District. As such, greater flexibility in design is available here, in terms of form, character and materials. While this area was historically associated with the Stockyards, little evidence of this remains today and new development is anticipated here that will be less influenced by historic precedents. Therefore, greater variety in building form and materials is appropriate in the Edge District. An objective is to provide services that support the overall Stockyards area and adjacent neighborhoods.

The intent is to promote best practices in urban design, by establishing a more pedestrian and bike friendly environment and to enhance connectivity within properties and to the other parts of the Stockyards area. Streets should be designed to be active and visually engaging at the sidewalk edge.

The Edge District includes the following sub-districts:*

1. SY-ENX: Neighborhood Mixed Use-40, -55
2. SY-ECC: Commercial Corridor-68

*The number represents the maximum height allowed in feet for that sub-district.

This Article includes development standards ([Div. 4.2](#) and [Div. 4.3](#)) that are mandatory and apply to all properties throughout the Edge District.

This Article also includes design guidelines ([Div. 4.4](#)). The design guidelines are intended to work in concert with the development standards to promote high quality development and best practices in urban design. They are provided as advisory information, except where a project seeks a major modification from the Urban Design Commission, in which case compliance is required.



Div. 4.2. Edge Sub-Districts

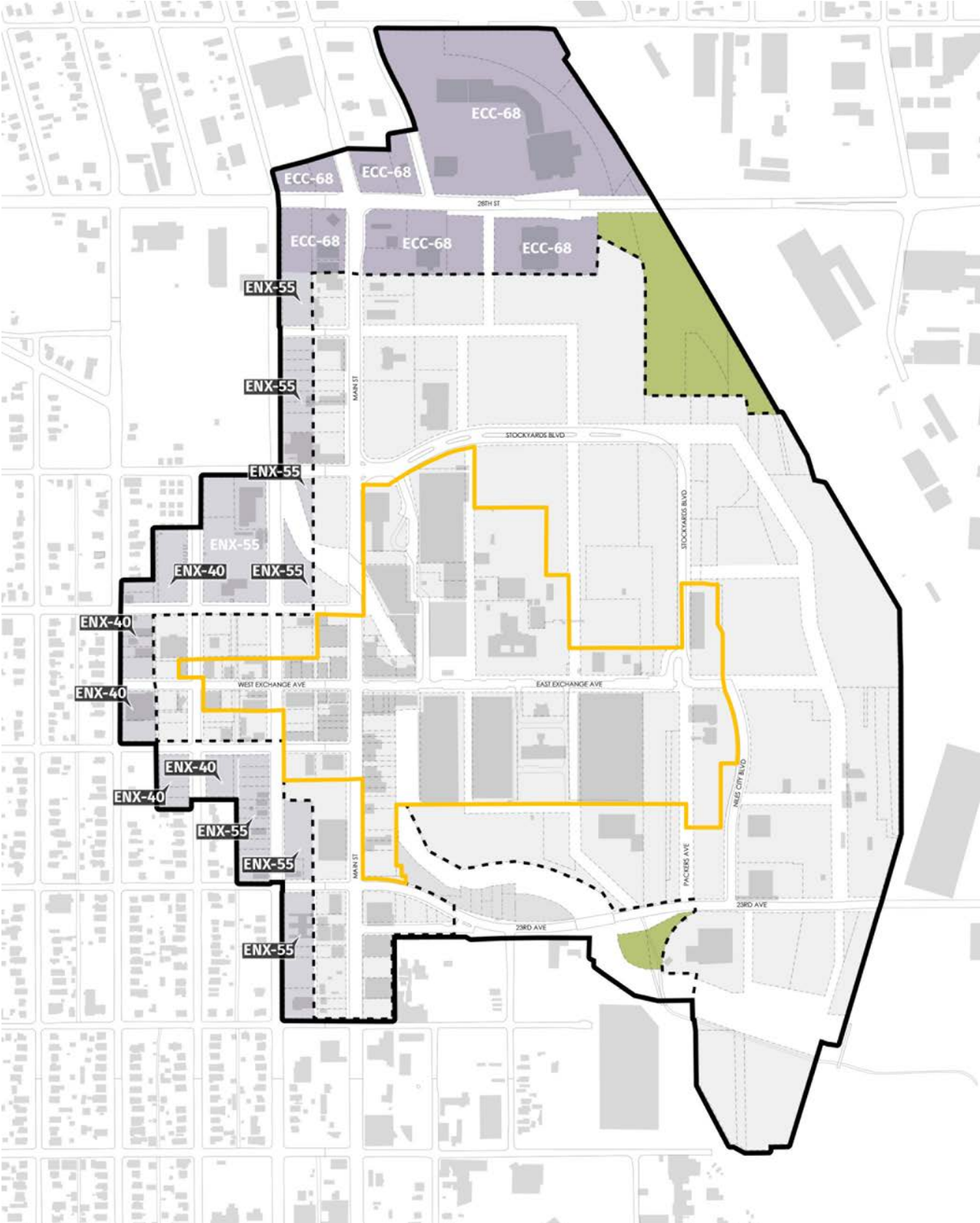

SEC. 4.2.1. NEIGHBORHOOD MIXED USE (SY-ENX)

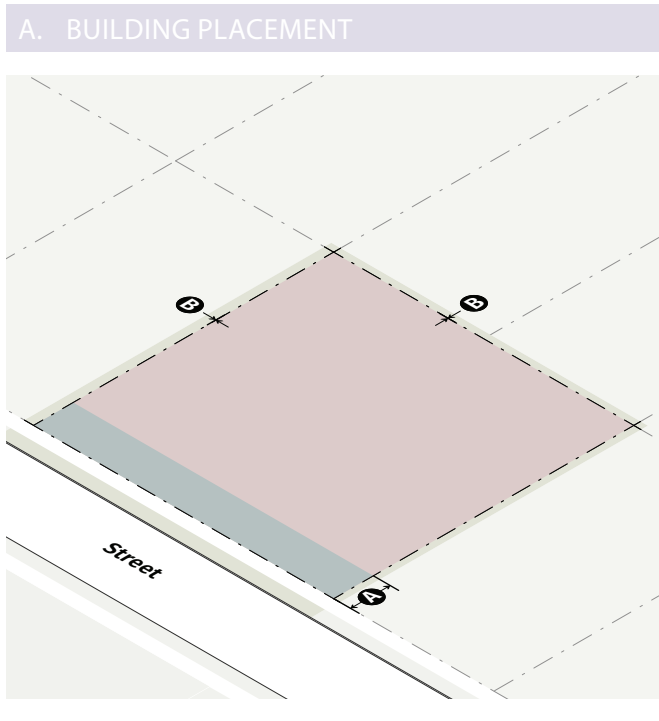

Intent

The Edge Neighborhood Mixed Use District (SY-ENX) is intended to serve as edges to the abutting Transitional Districts. A mix of uses, including commercial and multifamily residential is envisioned, which will provide supporting services and housing for the stockyards area. The intent is to promote best practices in urban design, by establishing a more pedestrian and bike friendly environment and to enhance connectivity within properties and to the other parts of the stockyards area. A wider range of street activation techniques is available in these areas.

Applicable Districts

SY-ENX-40, SY-ENX-55

Use

Allowed uses see [Div. 6.1](#)

Lot

| | |
|-------|-----|
| Area | n/a |
| Width | n/a |

Building Setbacks

| | |
|--------------------------|--------------|
| A Front | see Frontage |
| B Common lot line | 0' min |
| Alley | 5' min |

B. BULK AND MASS

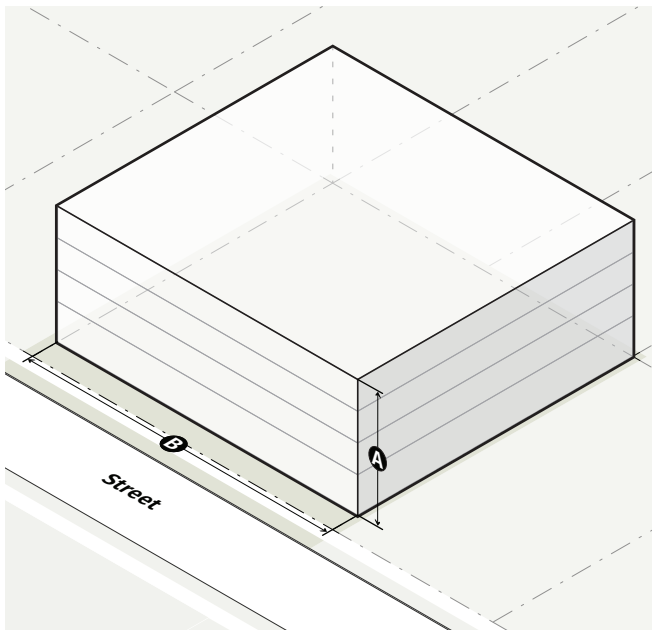

Building Height

| | |
|-------------------------|---------|
| A Maximum height | |
| SY-ENX-40 | 40' max |
| SY-ENX-55 | 55' max |
| Minimum height | n/a |

Roof Form see [Sec. 5.2.1](#)

| | |
|---------------------|---------|
| Flat | Allowed |
| Traditional parapet | Allowed |
| Barrel vault | Allowed |
| Gable: medium pitch | Allowed |
| Gable: steep pitch | Allowed |
| Hipped | Allowed |

Building Form see [Sec. 5.2.2](#)

| | |
|--|----------|
| B Street-facing building length | 150' max |
| Rectilinear building | Allowed |
| Angled, curved building | Allowed |

Articulation see [Sec. 5.2.3](#)

C. FRONTAGE

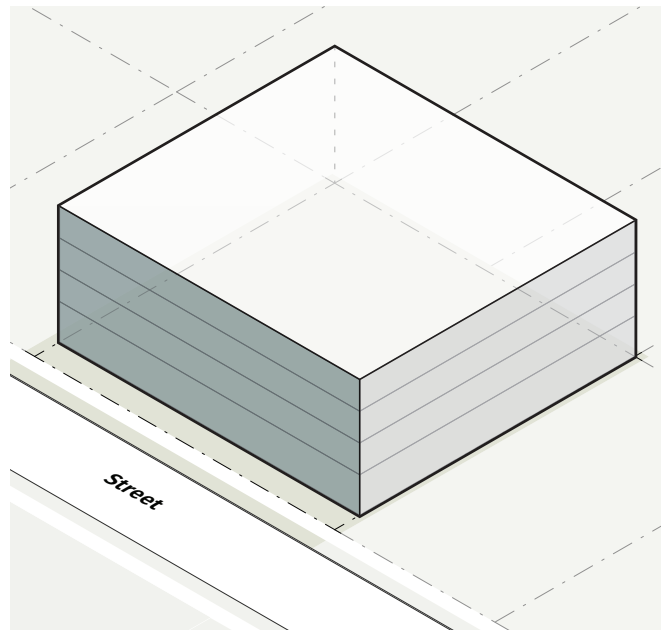

Applicable Frontages

see [Div. 4.3](#)

| | |
|---------------------|----|
| Pedestrian | ◇ |
| General | ◇ |
| Marine Creek | ◇ |
| Commercial Corridor | -- |

Building Materials see [Sec. 5.2.4](#)

SEC. 4.2.2. COMMERCIAL CORRIDOR (SY-ECC)



Intent

The Edge Commercial Corridor (SY-ECC) District intended to provide services that support the overall Stockyards area and adjacent neighborhoods. This may include retail shopfronts, hotels, offices and residential uses. The intent is to promote best practices in urban design, by establishing a more pedestrian and bike friendly environment and to enhance connectivity within properties and to the other parts of the Stockyards area. Streets should be designed to be visually active at the sidewalk edge. While this area was historically associated with the Stockyards, little evidence of this remains today and new development is anticipated here that will be less influenced by historic precedents. Therefore, greater flexibility in building shapes, size and materials is appropriate.

Applicable Districts

SY-ECC-68

Use

Allowed uses see [Div. 6.1](#)

A. BUILDING PLACEMENT

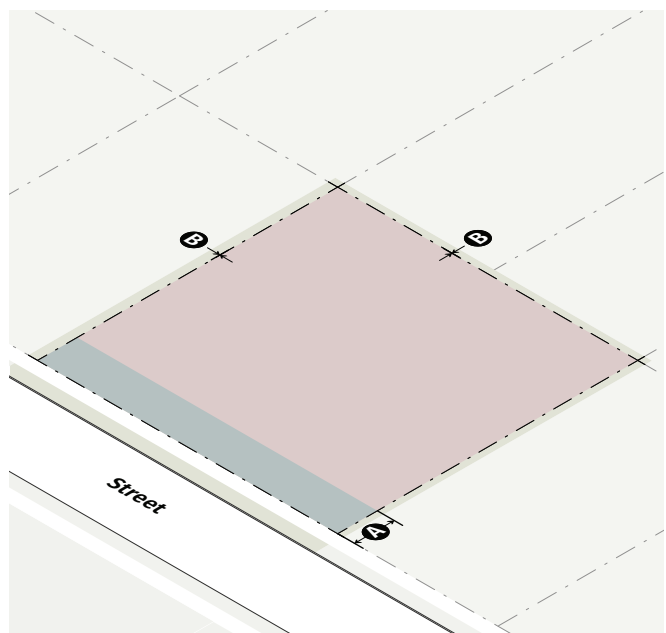

Lot

| | |
|-------|-----|
| Area | n/a |
| Width | n/a |

Building Setbacks

| | |
|--------------------------|--------------|
| A Front | see Frontage |
| B Common lot line | 0' min |
| Alley | 5' min |

B. BULK AND MASS

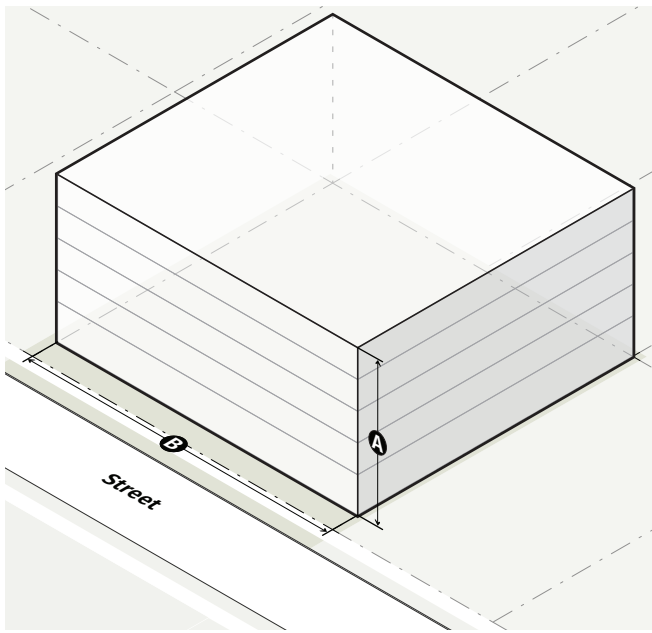

Access

| | |
|-------------------------|---------|
| A Maximum height | 68' max |
| Minimum height | n/a |

Roof Form see [Sec. 5.2.1](#)

| | |
|---------------------|---------|
| Flat | Allowed |
| Traditional parapet | Allowed |
| Barrel vault | Allowed |
| Gable: medium pitch | Allowed |
| Gable: steep pitch | Allowed |
| Hipped | Allowed |

Building Form see [Sec. 5.2.2](#)

| | |
|--|----------|
| B Street-facing building length | 300' max |
| Rectilinear building | Allowed |
| Angled, curved building | Allowed |

Articulation see [Sec. 5.2.3](#)

C. FRONTAGE

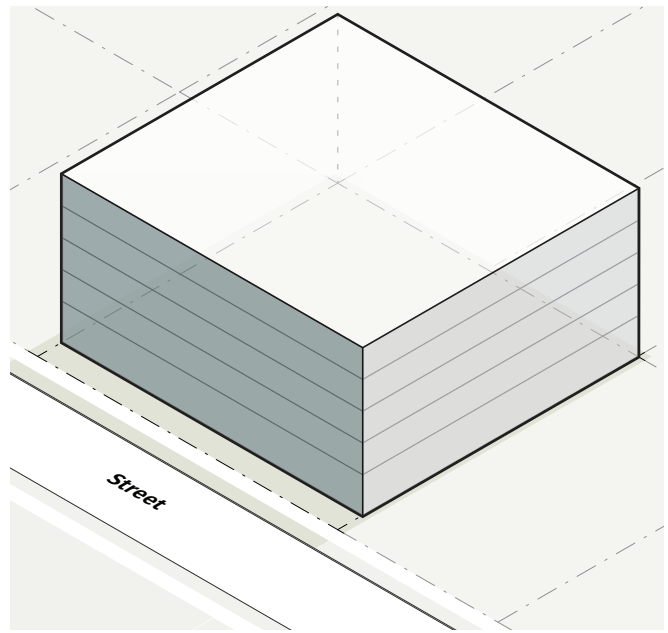

Applicable Frontages

see [Div. 4.3](#)

| | |
|---------------------|---|
| Pedestrian | ◇ |
| General | ◇ |
| Marine Creek | ◇ |
| Commercial Corridor | ◇ |

Building Materials see [Sec. 5.2.4](#)

Div. 4.3. Frontages

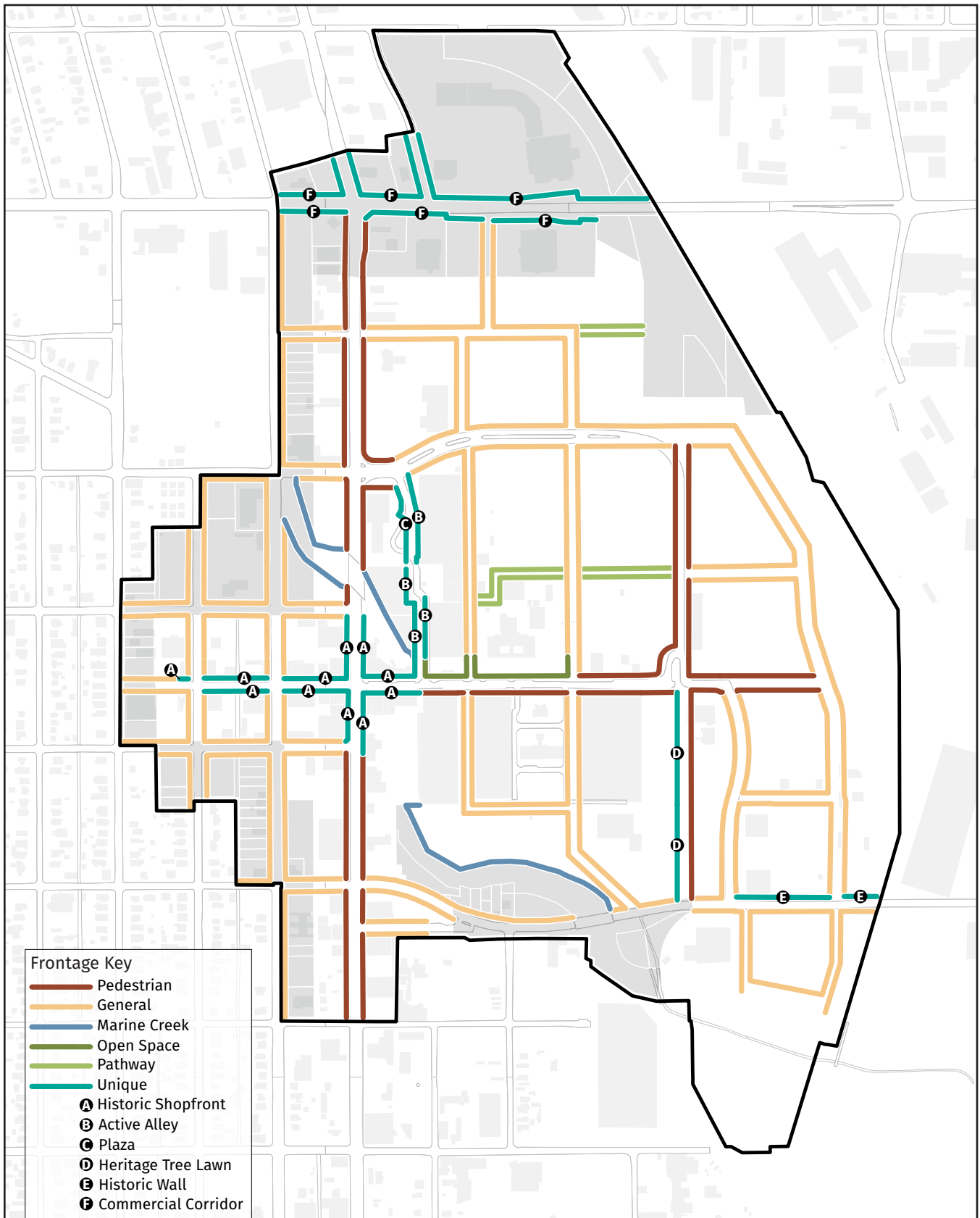

SEC. 4.3.1. PEDESTRIAN

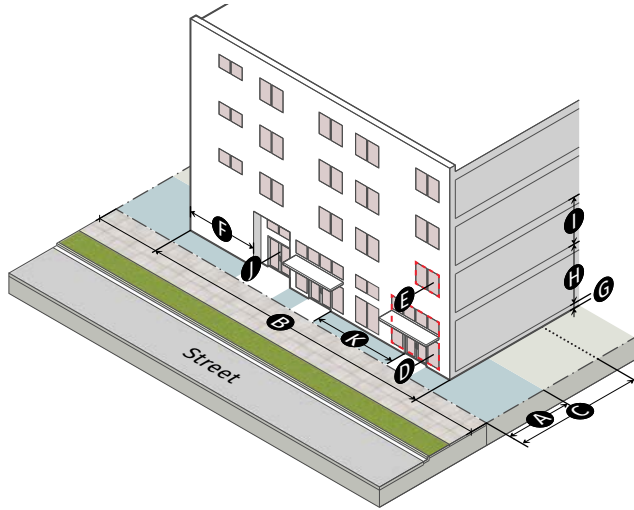

| Setbacks | |
|--|-------------------|
| A Build-to zone | 20' max |
| B % of building facade in build-to zone | 70% min |
| C Parking setback | 30' min |
| Transparency | |
| D Ground story | 60% min |
| E Upper story | 20% min |
| F Blank wall area | 35' max |
| Story Height | |
| G Ground floor elevation | 0' min/ 2' max |
| H Ground story | 12' min |
| I Upper story | 9' min |
| Pedestrian Access | |
| J Entrance facing street | Required |
| K Entrance spacing along street | 50' max |
| Building Elements | |
| | <u>Sec. 5.1.4</u> |
| Awning/canopy | ◇ |
| Balcony | ◇ |
| Forecourt | ◇ |
| Gallery | ◇ |
| Porch | -- |
| Stoop | -- |

SEC. 4.3.2. GENERAL

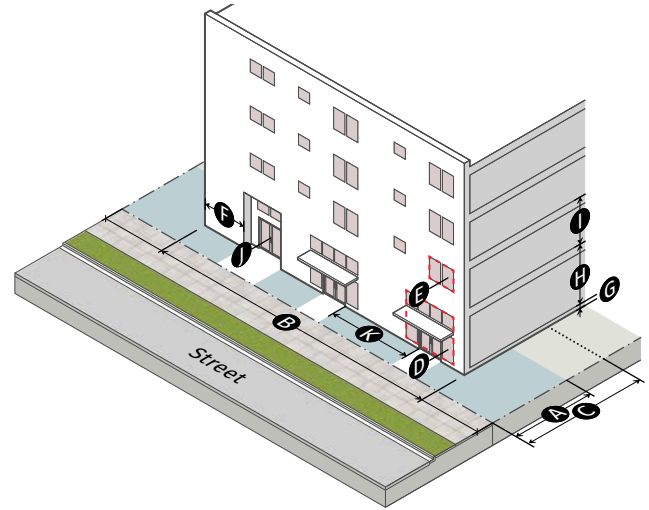

| | Nonresidential Ground Floor | Residential Ground Floor |
|--|--------------------------------|-----------------------------|
| Setbacks | | |
| A Build-to zone | 20' max | 20' max |
| B % of building facade in build-to zone | 60% min | 60% min |
| C Parking setback | 30' min | 30' min |
| Transparency | | |
| D Ground story | 40% min | 20% min |
| E Upper story | 20% min | 20% min |
| F Blank wall area | 35' max | 35' max |
| Story Height | | |
| G Ground floor elevation | 0' min/ 2' max | 2' min/ 5' max |
| H Ground story | 12' min | 12' min |
| I Upper story | 9' min | 9' min |
| Pedestrian Access | | |
| J Entrance facing street | Required | Required |
| K Entrance spacing along street | 75' max | 125' max |
| Building Elements | | |
| | <u>Sec. 5.1.4</u> | <u>Sec. 5.1.4</u> |
| Awning/canopy | ◇ | ◇ |
| Balcony | ◇ | ◇ |
| Forecourt | ◇ | ◇ |
| Gallery | ◇ | -- |
| Porch | -- | ◇ |
| Stoop | ◇ | ◇ |

SEC. 4.3.3. MARINE CREEK

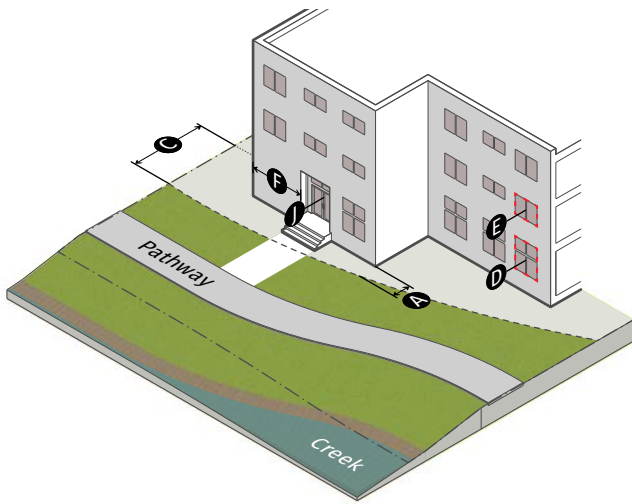

Setbacks

| | | |
|----------|--|---------|
| A | Front (measured from the Marine Creek Floodway and Beautification Easement Line) | 0' min |
| B | % of building facade in build-to zone | n/a |
| C | Parking setback | 30' min |

Transparency

| | | |
|----------|-----------------|---------|
| D | Ground story | 20% min |
| E | Upper story | 20% min |
| F | Blank wall area | 50' max |

Story Height

| | | |
|----------|------------------------|-----|
| G | Ground floor elevation | n/a |
| H | Ground story | n/a |
| I | Upper story | n/a |

Pedestrian Access

| | | |
|----------|------------------------------|----------|
| J | Entrance facing Creek | Required |
| K | Entrance spacing along Creek | n/a |

Building Elements Sec. 5.1.4

| | |
|---------------|---|
| Awning/canopy | ◇ |
| Balcony | ◇ |
| Forecourt | ◇ |
| Gallery | ◇ |
| Porch | ◇ |
| Stoop | ◇ |

SEC. 4.3.4. COMMERCIAL CORRIDOR

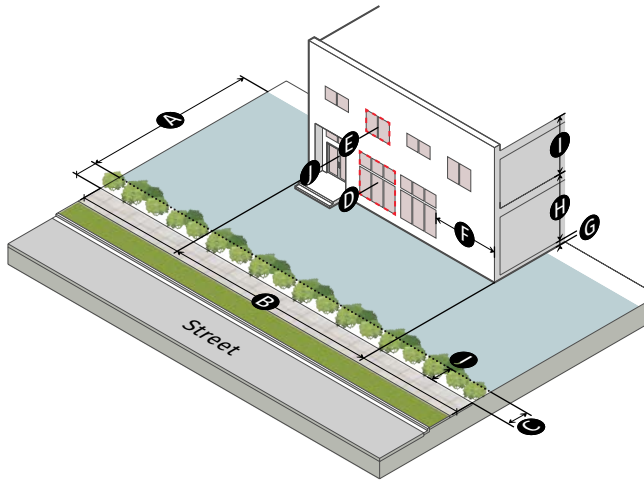

| | Nonresidential Ground Floor | Residential Ground Floor |
|--|--------------------------------|-----------------------------|
| Setbacks | | |
| A Build-to zone | 10' min/ 100' max | 10' min/ 100' max |
| B % of building facade in build-to zone | 50% min | 50% min |
| C Parking setback | 10' min | 10' min |
| Transparency | | |
| D Ground story | 50% min | 20% min |
| E Upper story | 20% min | 20% min |
| F Blank wall area | 30' max | 30' max |
| Story Height | | |
| G Ground floor elevation | 0' min/ 2' max | 2' min/ 5' max |
| H Ground story | 12' min | 12' min |
| I Upper story | 9' min | 9' min |
| Pedestrian Access | | |
| J Entrance facing street | Required | Required |
| K Entrance spacing along street | n/a | n/a |
| Building Elements | | |
| | <u>Sec. 5.1.4</u> | <u>Sec. 5.1.4</u> |
| Awning/canopy | ◇ | ◇ |
| Balcony | ◇ | ◇ |
| Forecourt | ◇ | ◇ |
| Gallery | ◇ | -- |
| Porch | -- | ◇ |
| Stoop | ◇ | ◇ |

Perimeter Planting

Applies only when surface parking abuts a public right-of-way (not including an alley)

| | |
|------------------------------|---|
| J Planting area depth | 10' min |
| Planting type | 3' min hedge/wall (see <u>Sec. 7.2.1.D</u>) |

Div. 4.4. Design Guidelines

This Division presents design guidelines for the Edge District. It includes a listing of key principles for each of the groupings of sub-districts ([Sec. 4.4.1](#) and [Sec. 4.4.2](#)), guidelines for site design ([Sec. 4.4.3](#)) and guidelines for building design ([Sec. 4.4.4](#)). Photographs and drawings included illustrate how design principles and guidelines should be exemplified in specific development projects.

SEC. 4.4.1. NEIGHBORHOOD MIXED USE (SY-ENX)

KEY PRINCIPLES

- A. Convey a sense of human scale through articulation of building facades.
- B. Convey the scale of traditional buildings by organizing buildings into modules.
- C. Provide a high level of activation at the street level
- D. Provide landscaped areas and open spaces that invite use and add visual interest

CHARACTER IMAGERY

These images illustrate the design guidelines and objectives for the Edge Neighborhood Mixed Use District.



- » Composition (base, middle & cap)
- » Variation in massing



- » Treatment of a side, or secondary wall:
- » Horizontal articulation (change in material)
- » Masonry
- » Vertical articulation (wall offset)
- » Landscaped edge



- » Composition (base, middle & cap)



» Vertical expression (change in materials and wall offsets)



» Vertical expression (wall offsets & change in cornice line)



» Vertical expression (wall offsets)
» Variation in cornice line



» Horizontal expression (change in materials, fenestration patterns)



» Street level activation (shopfront)



» Horizontal expression (change in materials, fenestration patterns)

SEC. 4.4.2. COMMERCIAL CORRIDOR (SY-ECC)

KEY PRINCIPLES

- A. Establish a pedestrian-friendly street edge with landscaping and buildings oriented to the street along 28th Street and other internal streets.
- B. Provide a sense of human scale and visual interest in building design.
- C. Improve connectivity within and among parcels.
- D. Accommodate new north-south street connections from 28th to Stockyards Boulevard.

CHARACTER IMAGERY

These images illustrate the design guidelines and objectives for the Edge Commercial Corridor District.



- » Vertical articulation (wall offsets)
- » Horizontal articulation (moldings, cornices and canopies)
- » Detailed stucco



- » Contemporary interpretation of arcade design
- » Vertical articulation (of columns)



- » Vertical articulation (wall offsets)
- » Horizontal articulation (moldings, cornices and canopies)



- » Vertical articulation (arcade/gallery)
- » Horizontal articulation (spandrels, stepbacks)



- » Entry identification
- » Base, middle & cap



- » Vertical articulation (change in materials, wall offsets)
- » Variation in cornice lines



- » Street level activation (arcade/gallery)
- » Variation in wall planes



- » Street activation of a secondary wall (foundation plantings and lattices)



- » Street level activation (shopfronts and outdoor use area)
- » Horizontal articulation (change in materials)
- » Vertical articulation (wall offsets)

SEC. 4.4.3. SITE DESIGN

OBJECTIVES

Highlight Landscapes and Views

Properties should be planned to emphasize landscaped areas and frame important views. This includes retaining significant existing landscape features, when feasible, and planning development with abutting properties in mind, such that opportunities to plan in a coordinated manner are maximized. Planning view corridors such that they align with those on adjacent properties, and complement historic view and circulation patterns, is also encouraged.

Each Development Should Help to Build a Sense of Neighborhood

Projects should be planned to relate to adjoining properties in a positive way, by promoting connections, by planning cooperatively to make joint use of natural features that span across properties, and with designs that convey a sense of visual continuity.

Provide Positive Open Space

These include public and private spaces, promenades, plazas and courtyards. In addition, integrate and maintain natural resources for the public to experience with open space areas.

Provide Landscaping that Enhances Views from the Public Way

Landscaping should contribute to the visual continuity and delight of the area, while complementing the identities of individual sites.

Provide Landscaping that Enhances Pedestrian Activity Within a Site

Landscaping should help to define functional areas within the site, such as walkways and outdoor use areas. These places should be designed to facilitate their use throughout the year.

Keep Parking Subordinate

Parking lots should not dominate the setting. They should be visually buffered.

A. Views

Views from the public right-of-way to natural features also should be maintained. Significant views may occur from major public open spaces, street intersections, bridges and roadway overlooks.

- 1. Enhance views from the public right-of-way to scenic natural features and landmarks, when feasible.
 - a. Locate a building to maintain key views as they are seen from the public right-of-way.



Enhance views from the public right-of-way to scenic natural features and landmarks, when feasible.

B. Auto Connectivity

Connections to auto circulation systems on adjoining properties and within properties that permit access without returning to the street, should be provided, when feasible, to permit convenient access and to reduce traffic on abutting public streets.

- 1. Provide direct automobile access within or to an abutting property, when feasible.
 - a. Even where an adjoining parcel is presently undeveloped, reserve the opportunity to provide a connection in the future.

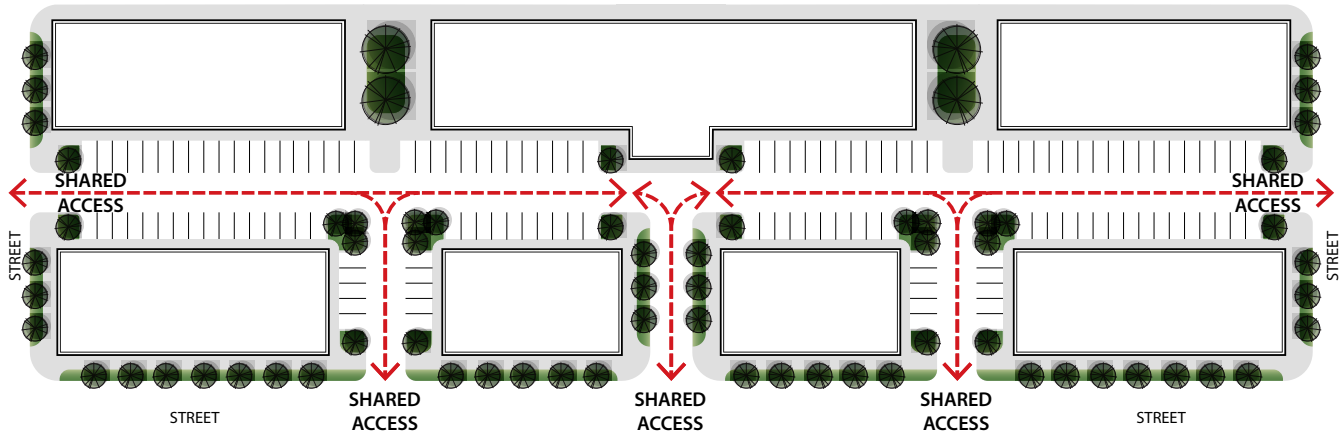

Use shared drives to access parking areas.



Provide convenient connections for pedestrians and bicyclists between buildings on an individual site.

C. Pedestrian and Bicycle Connectivity

Safe and convenient pedestrian and bicycle access should be provided to the regional trail system and among properties to achieve a sense of being an integrated neighborhood and to reduce dependence upon automobiles. In addition, the internal site circulation system should be coordinated.



SEE DIV. 8.2 FOR NEW CONNECTION STANDARDS

1. Provide convenient connections to regional and neighborhood pedestrian and bikeway circulation systems.
 - a. Provide connections to regional trails when they abut a property or are in close proximity.
 - b. Provide a clearly defined, direct connection from internal walkways to adjoining public sidewalks.
 - c. Provide convenient pedestrian and bikeway connections among abutting properties.

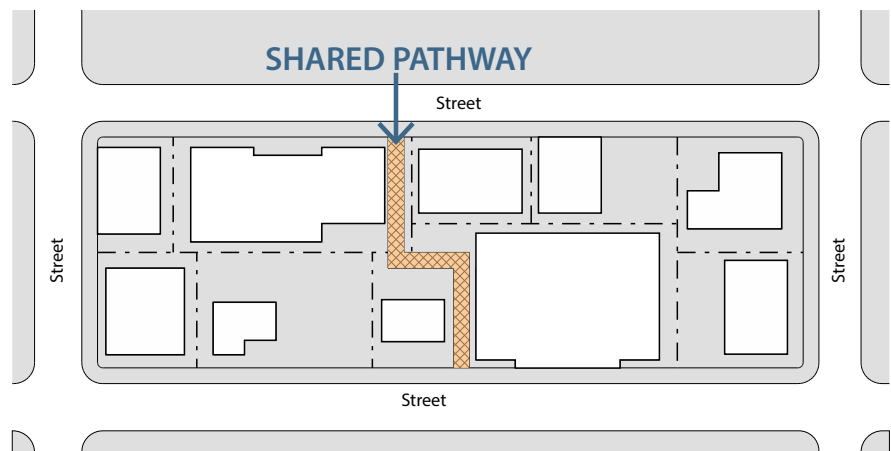

Provide convenient connections to regional and neighborhood pedestrian and bikeway circulation systems.

D. Open Space

The development of open space is encouraged in order to enhance a site as a place for pedestrians. Buildings and other site functions should be planned to create outdoor space that serve public, private, passive and active uses.

1. Develop open space for the site.
 - a. Define open space by clustering buildings in larger developments.
 - b. Position this space such that it can be shared by adjoining buildings, when feasible.
 - c. Consider orienting open space to views of activities, architectural landmarks or natural features to provide visual interest.
2. Provide public access and views to open space, when feasible.
 - a. Decorative surface materials and landscaping should be integrated as design features.
 - b. Reuse historic brick pavers whenever feasible.



The development of open space is encouraged in order to enhance a site as a place for pedestrians.



Reuse historic brick pavers whenever feasible.



Position outdoor space such that it can be shared by adjoining buildings, when feasible.

E. Landscape

Landscaped areas that can be enjoyed, both visually and functionally, should be provided in a project when feasible. Landscaped areas of an individual parcel should be coordinated with that of adjoining properties as well, such that mutual benefits can be maximized.



SEE DIV. 7.2 FOR LANDSCAPING STANDARDS

1. Coordinate landscaped areas with that of adjacent parcels such that they may be perceived as a larger area.
 - a. Also position landscaped areas to link access points with those of adjoining properties.
2. Organize uses to maximize natural assets of the site.
 - a. When a stormwater detention facility is to be provided, position it in green space and design it to be an amenity.
 - b. Locate a service area away from natural green space that is to be retained on the site.



Use a consistent plant palette throughout the property.



Landscaped areas that can be enjoyed, both visually and functionally, should be provided in a project when feasible.

F. Site Lighting

Site lighting should be designed to facilitate safe and convenient circulation of motorists, bicyclists and pedestrians. Light levels should be sufficient for safety. However, light spill onto adjacent properties and into the night sky should be minimized.



SEE DIV. 7.3 FOR SITE LIGHTING STANDARDS

1. Minimize the level of lighting across parking areas.
 - a. Focus higher light levels at key crossing points and intersections, rather than uniformly across a lot.
 - b. In other areas of a surface lot, provide a lower level of lighting, while also meeting safety needs.
2. Provide lighting for pedestrian ways that is appropriately scaled to walking.
 - a. Mount lights for pedestrian ways on short poles or consider using light posts (bollards).
3. Light fixtures should be in character with the setting.
 - a. Fixtures should be compatible with architectural and site design elements.



Provide lighting for pedestrians that is appropriately scaled to walking.

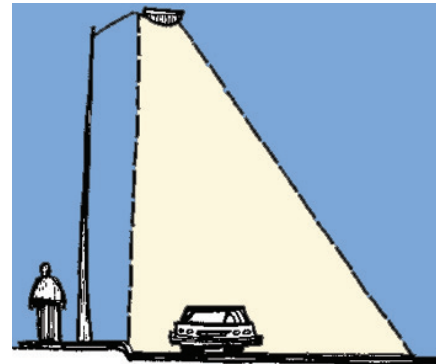

Lighting should be shielded to prevent off-site glare.

G. Service Areas

Service areas should be visually unobtrusive and should be integrated with the design of the site and associated buildings.



SEE SEC. 7.2.3 FOR SCREENING STANDARDS

1. Minimize the visual impacts of service areas.
 - a. Orient a service entrance, waste disposal area or other similar use toward service lanes and away from major streets.
 - b. Screen service entrances with walls or plantings.
 - c. When it will be visible from a public way, a service area screen should be in character with the building and site it serves.



Minimize the visual impacts of service areas.

SEC. 4.4.4. BUILDING DESIGN

OBJECTIVES

Complement the Design Traditions of the Stockyards Area

Buildings should complement the design traditions of the Stockyards area, in terms of building and roof forms, scale, materials and other design elements. Flat roofs with varied parapet lines and cornices are a key part of this tradition. Rectilinear building forms are the primary building form and should be provided.

Buildings that appear to be in scale with those seen traditionally also should be encouraged. Where a new building would be larger than those existing in the area, it should establish a transition in scale, to reduce the impact of building scale on the adjacent property, as well as on the neighborhood.

Achieve High Quality Design

Buildings in the commercial corridors should convey a high quality of design, in terms of their materials and details, as well as through a consistent organization of forms and elements. This quality should establish a standard for design throughout the community.

Design for Durability

Buildings should be designed for the long term with durable materials.

Enhance the Pedestrian Experience

Each improvement project should contribute to a pedestrian-friendly environment. This includes defining the street edges and walkways with buildings and spaces that are visually interesting and that attract pedestrian activity.



Buildings should complement the design traditions of the Stockyards Area, in terms of building and roof forms, scale, materials and other design elements.



Buildings in the commercial corridors should convey a high quality of design, in terms of their materials and details, as well as through a consistent organization of forms and elements.



Enhance the pedestrian experience. Each improvement project should contribute to a pedestrian-friendly environment.

A. Building Character

A new building should complement the design precedents of the stockyards area while expressing its own time.

1. Innovative new designs that draw upon regional design traditions are preferred.
 - a. Design a building to provide a sense of authenticity in building and material.
 - b. Standardized “franchise” style architecture is discouraged.
2. The exact imitation of historic styles is inappropriate for new construction.
 - a. Contemporary interpretations of historic building forms, massing, materials and details that occurred traditionally in the form district are appropriate.



Design a building to provide a sense of authenticity in building material.



Innovative new designs that draw upon regional design traditions are preferred. These example buildings incorporate timber framing that resembles the construction of the pen areas in the Stockyards.

ARTICLE 5. RULES FOR ALL DISTRICTS

| | |
|--|------|
| Div. 5.1. Measurements and Exceptions..... | 5-2 |
| Sec. 5.1.1. Building Placement | 5-2 |
| Sec. 5.1.2. Bulk and Mass | 5-3 |
| Sec. 5.1.3. Frontage | 5-4 |
| Sec. 5.1.4. Building Elements | 5-9 |
| Div. 5.2. Architectural Standards..... | 5-12 |
| Sec. 5.2.1. Roof Form | 5-12 |
| Sec. 5.2.2. Building Form | 5-13 |
| Sec. 5.2.3. Articulation | 5-14 |
| Sec. 5.2.4. Building Materials | 5-16 |

Div. 5.1. Measurements and Exceptions

Sec. 5.1.1. Building Placement

A. Building Setbacks

All buildings and structures (principal and accessory) must be located at or within the required building setbacks except as listed below. No building or structure can extend into a required easement.

1. Building Features

- a. Awnings/canopies, balconies, galleries, porches and stoops may extend into a required front setback as stated in [Sec. 5.1.4](#).
- b. Building eaves, roof overhangs, gutters, downspouts, light shelves, bay windows and oriels less than 10 feet wide, cornices, belt courses, sills, buttresses or other similar architectural features may encroach up to 3 feet into a required setback, provided that such extension is at least 2 feet from the vertical plane of any lot line.
- c. Chimneys or flues may encroach up to 4 feet, provided that such extension is at least 2 feet from the vertical plane of any lot line.
- d. Unenclosed patios, decks, balconies, stoops, porches, terraces or fire escapes may encroach into a common lot line setback, provided that such extension is at least 5 feet from the vertical plane of any lot line.
- e. Handicap ramps may encroach to the extent necessary to perform their proper function.

2. Site Features

- a. Structures below and covered by the ground may encroach into a required setback.
- b. Fences and walls (including retaining walls and railings) may encroach into a required setback (see [Sec. 7.2.4](#)).
- c. Dumpster and recycling enclosures may encroach into a common lot line setback only (see [Sec. 7.2.3](#) for screening standards).
- d. Landscaping, trees, planters, lighting, benches, trash receptacles, public art, water features, bollards, and other street furniture may encroach into a required setback.
- e. Signs may encroach into a required setback (see [Div. 7.4](#)).
- f. Pedestrian or cyclist facilities, such as sidewalks, pathways and bicycle parking, may encroach into a required setback.
- g. Driveways may encroach into a required setback.
- h. Accessory structures, such as kiosks, concession stands and similar structures, may encroach into a required setback (see [Sec. 2.4.5.F](#)).
- i. Outdoor storage and outdoor display may encroach into a required setback (see [Div. 7.5](#)).

3. Low Impact Stormwater Features

- a. Low impact stormwater management features may encroach into a required front setback including, but not limited to:

- i. Rain barrels or cisterns, 6 feet or less in height;
 - ii. Planter boxes;
 - iii. Bio-retention areas; and
 - iv. Similar features, as determined by the FBC Administrator.
- b. Low impact stormwater management features listed above may encroach into a required common lot line setback, provided such extension is at least 1 foot from the vertical plane of any lot line.
4. Mechanical Equipment and Utility Lines
- a. Mechanical equipment, such as HVAC units, swimming pool pumps or filters, security lighting, and tankless water heaters may encroach into a required common lot line setback, provided that the encroachment is at least 2 feet from the vertical plane of any lot line (see [Sec. 7.2.3](#) for screening standards).
 - b. Minor structures accessory to utilities, such as hydrants, transformers, miscellaneous utility cabinets, electric meters, aboveground water utility devices, cable television or phone utility boxes, and wires and conduits may encroach into a required common lot line setback, provided that the encroachment is at least 2 feet from the vertical plane of any lot line (see [Sec. 7.2.3](#) for screening standards).

Sec. 5.1.2. Bulk and Mass

A. Building Height

- 1. Building height is the vertical distance in feet measured from the curb level to the highest point of the roof surface, if a flat roof; to the deck line of

a mansard roof; and to the mean height level between eaves and ridge for a gable, hip or gambrel roof.

- 2. On a flat roof, a parapet wall may exceed the height limit by a maximum of 6 feet.

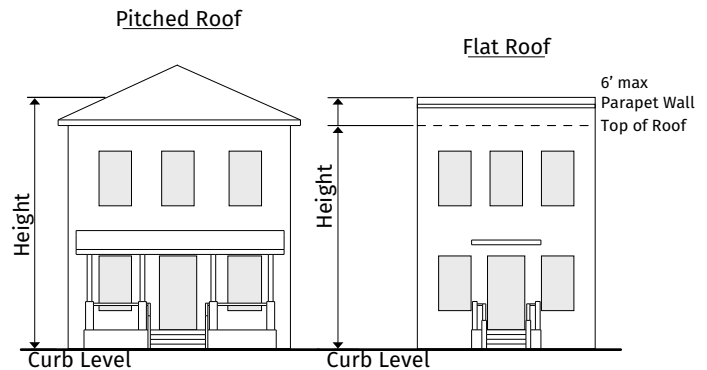

B. Height Encroachments

All buildings and structures must be located at or below the maximum height limit except as listed below.

- 1. The maximum height limits of the district do not apply to spires, belfries, cupolas, domes not intended for human occupancy; monuments, water tanks, water towers or other similar structures which, by design or function, must exceed the established height limits.
- 2. The following may exceed the established height limit provided they do not exceed the maximum height by more than 6 feet:
 - a. Chimney, flue or vent stack;
 - b. Flagpole;
 - c. Vegetation or landscaping associated a green roof;
 - d. Skylights;
 - e. Unroofed and unenclosed rooftop terrace;
 - f. Parapet wall; and
 - g. Solar panels.

3. The following may exceed the established height limit provided they do not exceed the maximum building height by more than 15 feet, do not occupy more than 25% of the roof area, and are set back at least 10 feet from the edge of the roof:
 - a. Elevator or stairway access to roof;
 - b. Rooftop shade structure;
 - c. Wind turbines, rainwater collection systems.
 - d. Greenhouse; and
 - e. Mechanical equipment.

C. Building Mass

1. Street-Facing Building Length

Street-facing building length is the maximum length of a building or structure.

Sec. 5.1.3. Frontage

A. Build-to-Zone

1. The build-to zone is the area on the lot or site where a percentage of the building facade must be located, measured as a minimum and maximum setback range from the edge of the right-of-way.
2. The required percentage specifies the amount of the building facade that must be located in the build-to zone, measured based on the width of the building or buildings divided by the width of the lot.

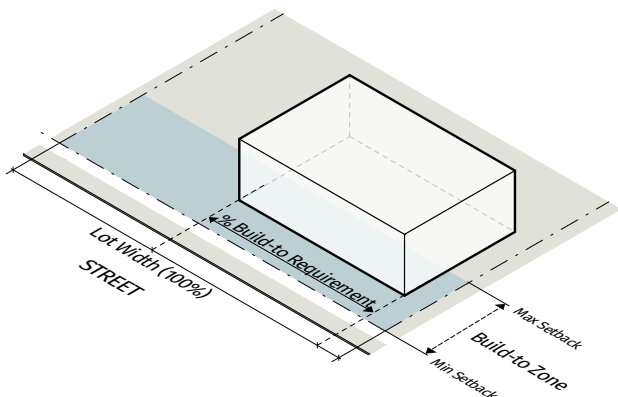

3. On a corner lot, a building facade must be placed within the build-to zone for the first 30 feet along the street extending from the block corner, measured from the intersection of the two right-of-way lines.

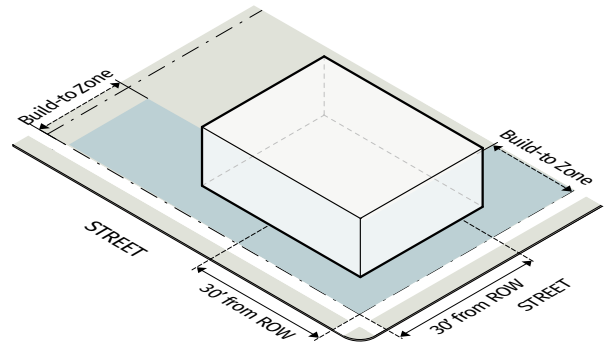

4. The build-to zone applies to the 1st and 2nd stories of a building.
5. With the exception of parking spaces, all structures and uses allowed on the lot are allowed within the build-to zone.
6. A forecourt meeting the requirements of [Sec. 5.1.4.D](#) is considered part of the building for the purpose of meeting the build-to requirement.
7. A chamfered corner on the ground floor of no more than 20 feet in width that extends outside of the build-to zone is considered part of the building for the purpose of meeting the build-to requirement.

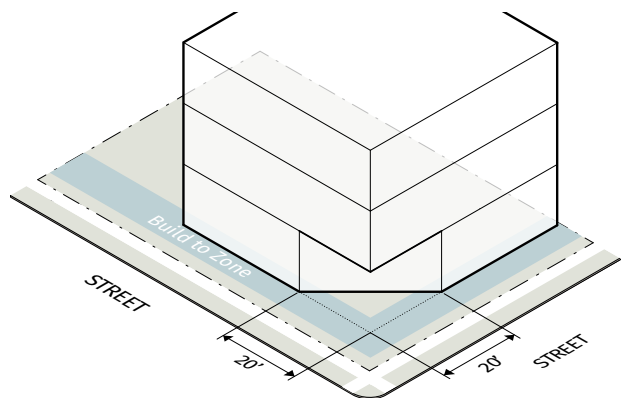

B. Build-to-Zone: New Buildings

1. All new buildings must be placed in the build-to zone until the required percentage for the entire lot or site has been met.

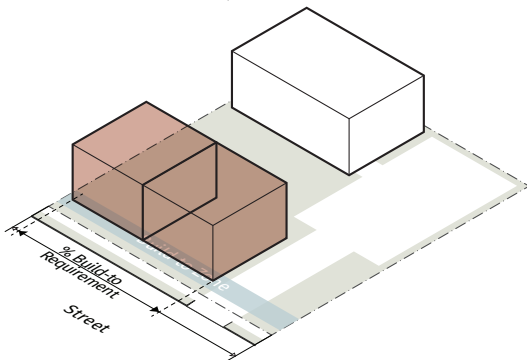
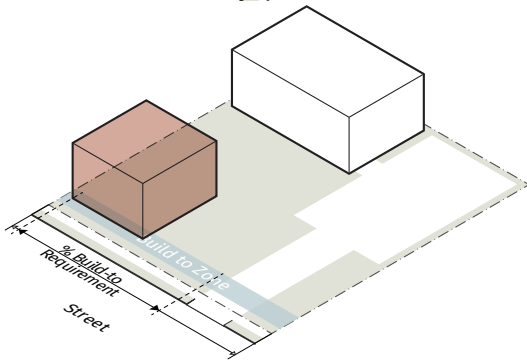
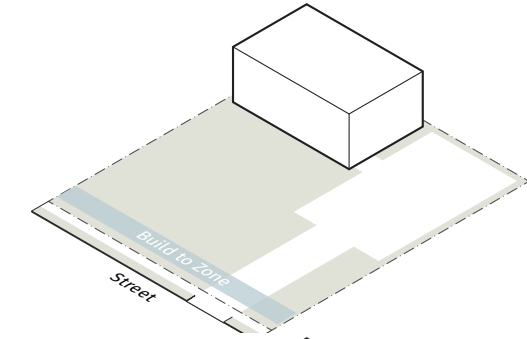

2. Once the required percentage has been met for the entire lot or site, new buildings may be placed outside of the build-to zone.

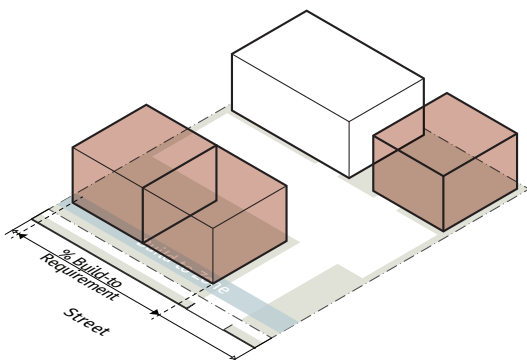

C. Build-to Zone: Additions

1. Front Additions

Any addition to the front of an existing building must be placed in the build-to zone. The addition does not have to meet required percentage for the entire lot or site. Front additions no greater than 10% cumulatively of the existing building footprint are allowed outside of the build-to zone.

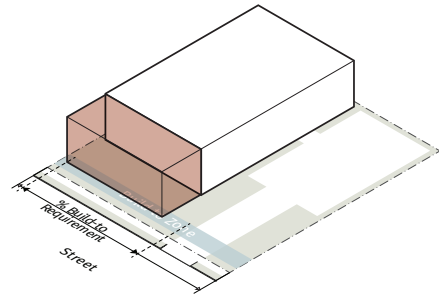

2. Side Additions

Side additions no greater than 20% cumulatively of the existing building footprint are allowed outside of the build-to zone. Once the required percentage for the entire lot or site has been met side additions of any size are allowed.

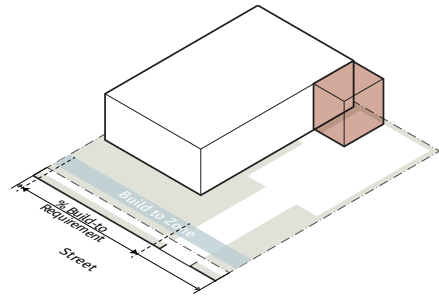

3. Rear Additions

Rear additions are allowed outside of the build-to zone.

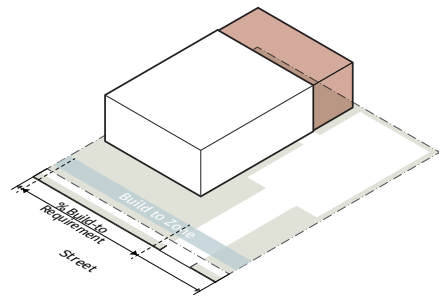

D. Transparency

1. Transparency applies to all building facades that face a designated Frontage.
2. Transparency is the minimum percentage of windows and doors that must cover a ground or upper story facade.
3. Clear glazing must have a visible transmittance rating of 0.5 or greater to count towards the transparency requirement.
4. Ground story transparency is measured between 2 and 12 feet above the abutting sidewalk. Upper story transparency is measured from top of the finished floor to the top of the finished floor above. When there is no floor above, upper story transparency is measured from the top of the finished floor to the top of the wall plate above.

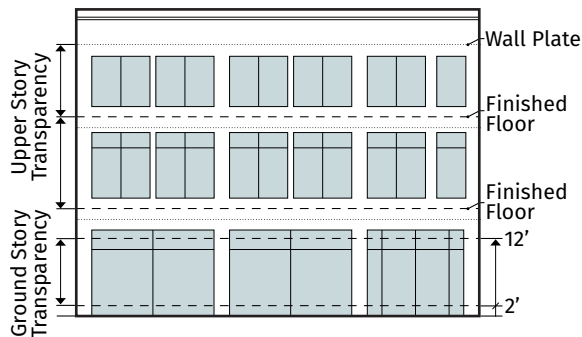

5. In the Pedestrian, Active Alley and Historic Shopfront Frontages, a minimum of 60% of the required transparency must allow views into the ground story use for a depth of at least 8 feet. Windows cannot be made opaque by window treatments (except operable sunscreen devices within the conditioned space).

E. Blank Wall Area

1. Blank wall area applies to all building facades that face a designated Frontage.
2. Blank wall area means a portion of the exterior facade of the building that does not include: windows or doors; columns, pilasters

or other articulation greater than 12 inches in depth; or a substantial material change (paint color is not considered a substantial change).

3. Blank wall area applies in both a vertical and horizontal direction.

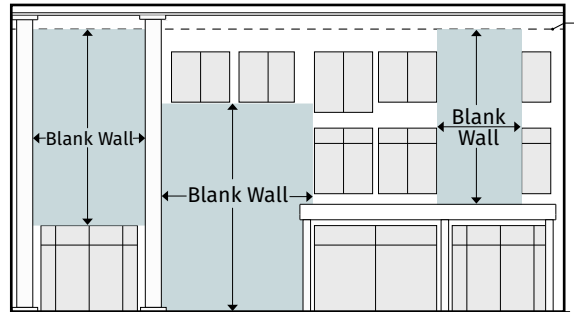

F. Transparency Alternatives

The following alternatives may count towards a portion of the transparency requirement and can be used in singular or combination. Alternatives may count for no more than 50% of the total transparency requirement.

Translucent Glazing
 Translucent, fritted, patterned, or color glazing



Display Cases
 Wall mounted or recessed display cases at least 4 feet in height.



Living Wall
 Green facade system, green or living wall, or similar vegetation



Outdoor Dining Area
 Outdoor dining/seating located between the building and street.



G. Ground Floor Elevation

1. Ground floor elevation is measured from top of the adjacent curb to the top of the finished ground floor.
2. Minimum ground floor elevation applies to the first 30 feet of the lot measured from the right-of-way.

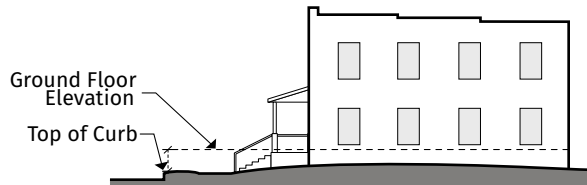

H. Story Height

Story height is the height of each story of building and it is measured from the top of the finished floor to the top of the finished floor above. When there is no floor above, upper story height is measured from the top of the finished floor to the top of the wall plate above.

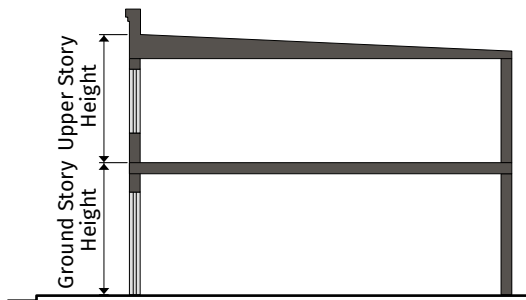

I. Pedestrian Access

1. An entrance providing both ingress and egress, operable to residents at all time or customers during operating hours, is required to meet the pedestrian access requirement.
2. Additional entrances off another street, pedestrian area, open space or internal parking area are allowed.
3. The entrance spacing requirement must be met for each building, but are not applicable to adjacent buildings.

4. An angled entrance provided at the corner of a building meets the entrance requirements for two intersecting Frontages. However, the entrance spacing requirement applies separately for each Frontage.
5. Entrance spacing is measured from the edge of door to the edge of the next door.

Sec. 5.1.4. Building Elements

A. Intent

The following standards are intended to ensure that certain building elements when added to a Frontage are of sufficient size to be both usable and functional and be architecturally compatible with the Frontage they are attached to. Building elements are allowed by Frontage, see [Div. 2.3](#), [Div. 3.3](#) or [Div. 4.3](#), and may be used individually or in combination as allowed. Requirements for each building element are listed below.

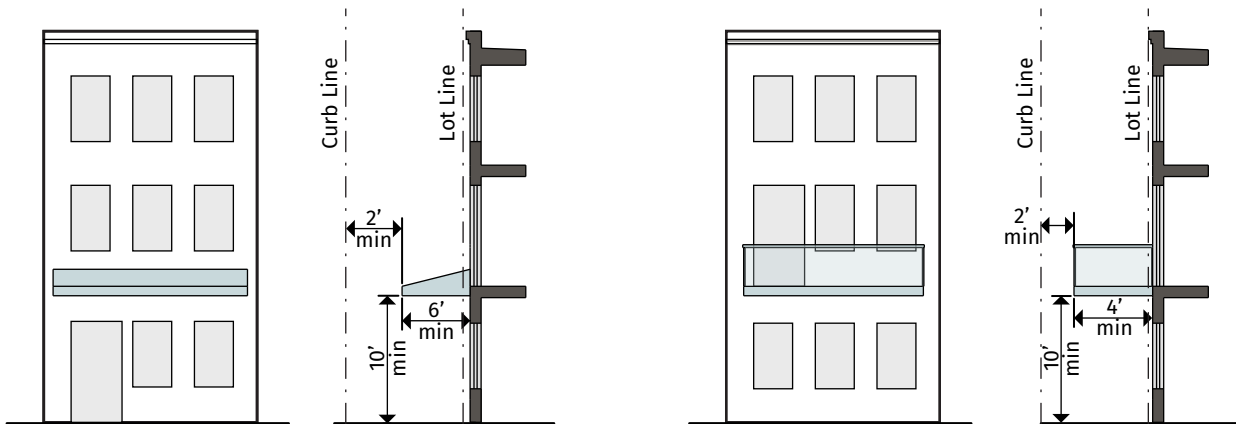

B. Awning/Canopy

A wall-mounted, cantilevered structure providing shade and cover from the sun.

1. An awning/canopy must be a minimum of 10 feet clear height above the sidewalk and must have a minimum depth of 6 feet.
2. An awning/canopy may extend into a required front setback.
3. Subject to the issuance of a right-of-way encroachment agreement, an awning/canopy may encroach over the right-of-way but must be at least 2 feet inside the curb line or edge of pavement, whichever is greater.

C. Balcony

A platform projecting from the wall of an upper-story of a building with a railing along its outer edge, often with access from a door or window.

1. A balcony must be at least 4 feet deep.
2. A balcony must have a clear height above the sidewalk of at least 10 feet.
3. A balcony may be covered and screened, but cannot be fully enclosed.
4. A balcony may extend into a required front setback.
5. Subject to the issuance of a right-of-way encroachment agreement, a balcony may encroach over the right-of-way but must be at least 2 feet inside the curb line or edge of pavement, whichever is greater.



D. Forecourt

An open area at grade, or within 30 inches of grade, that serves as an open space, plaza or outdoor dining area. Where allowed, a forecourt meeting the following requirements is considered part of the building for the purpose of meeting a required build-to.

1. A forecourt must be no more than one-third of the length of the building face, and in no case longer than 35 feet in width.
2. A maximum of one forecourt is permitted per building.
3. The standards above apply only to a forecourt used to meet a portion of a required build-to. A forecourt not used to meet a portion of a required build-to is not regulated above.

E. Gallery

A covered passage extending along the outside wall of a building supported by arches or columns that is open on three sides.

1. A gallery must have a clear depth from the support columns to the building's facade of at least 8 feet and a clear height above the sidewalk of at least 12 feet.
2. A gallery may extend into a required front setback.
3. A gallery must be contiguous and extend over at least 75% of the width of the building facade from which it projects.
4. Subject to the issuance of a right-of-way encroachment agreement, a gallery may encroach into the right-of-way but must be at least 2 feet inside the curb line or edge of pavement, whichever is greater.

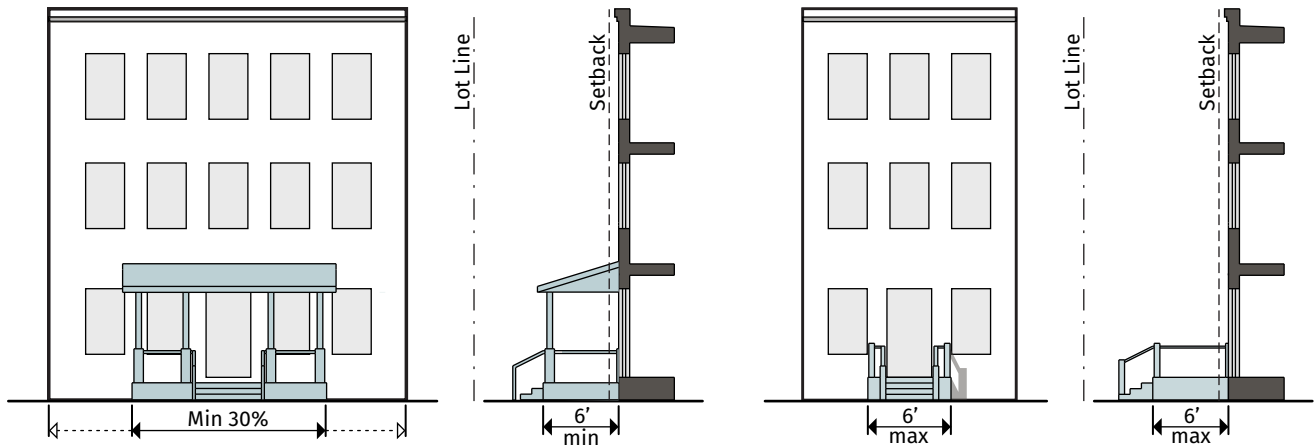

F. Porch

A raised structure attached to a building, forming a covered entrance to a doorway.

1. A porch must be at least 6 feet deep (not including the steps).
2. A porch must be roofed and may be screened, but cannot be fully enclosed.
3. A porch must be contiguous, with a width not less than 30% of the building facade from which it projects.
4. A porch, including the steps, may extend into a required front setback.
5. A porch, including the steps, may not encroach into the right-of-way.

G. Stoop









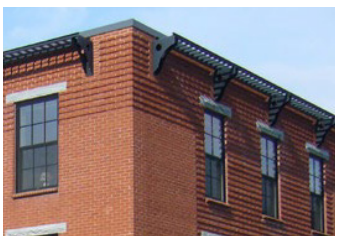

A small raised platform that serves as an entrance to a building.

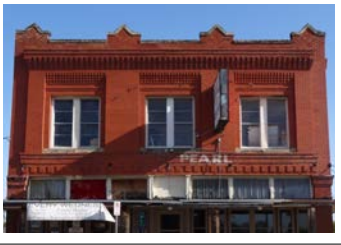
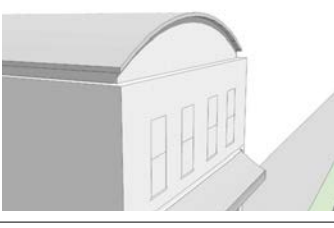
1. A stoop must be no more than 6 feet deep (not including the steps) and 6 feet wide.
2. A stoop may be covered but cannot be fully enclosed.
3. A stoop, including the steps, may extend into a required front setback.
4. A stoop, including the steps, may not encroach into the right-of-way.

Div. 5.2. Architectural Standards

Sec. 5.2.1. Roof Form

For new buildings in a Historic District, roof forms must be compatible with the historic context. Those in the Transition Districts must be consistent with those seen historically in those areas, while accommodating new designs. In an Edge District, more variety in roof forms are allowed. Roof forms are allowed by sub-district (see [Div. 2.2](#), [Div. 3.2](#) or [Div. 4.2](#)). Allowed roof forms may be used individually or in combination. Descriptions of each roof form are listed below.

| | | |
|---|--|---|
| <p>Flat</p> <p>Flat roof (with a pitch less than 2:12) with a low parapet wall (less than 6 feet in height) on the outside edge of the roof.</p> |  |  |
| <p>Traditional Parapet</p> <p>Roof with parapet wall (6 feet or more in height) on the outside edge of the roof that conceals a flat, barrel vaulted, gabled or hipped roof.</p> |  |  |
| <p>Barrel Vault</p> <p>A roof having an exposed curved form, often semicircular in cross section, with no angle change.</p> |  |  |
| <p>Gable - Medium Pitch</p> <p>An exposed triangular roof form with a pitch of 2:12 and greater but less than 8:12.</p> |  |  |
| <p>Gable - Steep Pitch</p> <p>An exposed triangular roof form with a pitch of 8:12 and greater.</p> |  |  |
| <p>Hipped</p> <p>An exposed four-sided roof form having sloping ends and sides.</p> |  |  |

Sec. 5.2.2. Building Form

Traditionally, most buildings in the Stockyards area had a rectilinear building form. Continuing this tradition will help to convey the arrangement of buildings, paths, streets and rail lines that existed. However, where a curved or angled street exists or is proposed, an angled or curved building form may not be appropriate. Therefore, building form is regulated by sub-district (see [Div. 2.2](#), [Div. 3.2](#) or [Div. 4.2](#)). Allowed building forms may be used individually or in combination. Descriptions of each building form are listed below.

Rectilinear

A building facade that changes at an angle of 90 degrees (right-angle).

An accent element on a rectilinear building may be curved or angled; however, the element must be subordinate in size when compared to the primary rectilinear form of the building.

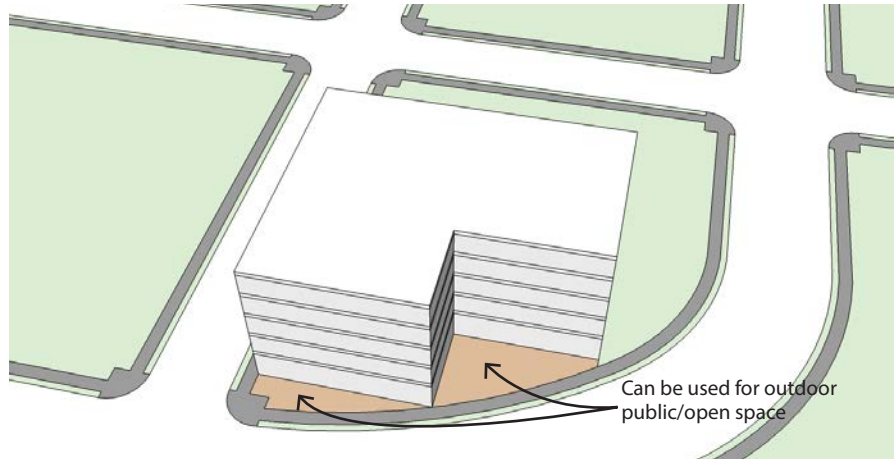

Angled

A building facade that changes at an angle greater than 90 degrees and less than 180 degrees (obtuse angle).

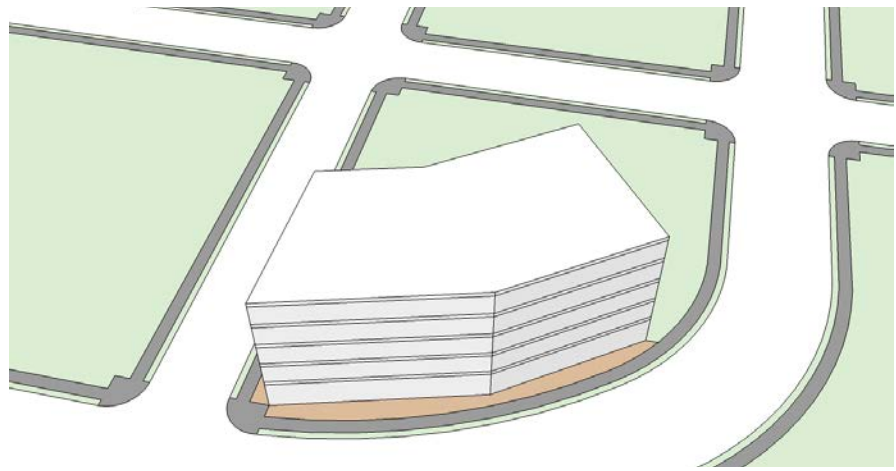

Curved

A building facade that bends in a smooth, continuous way without angles.

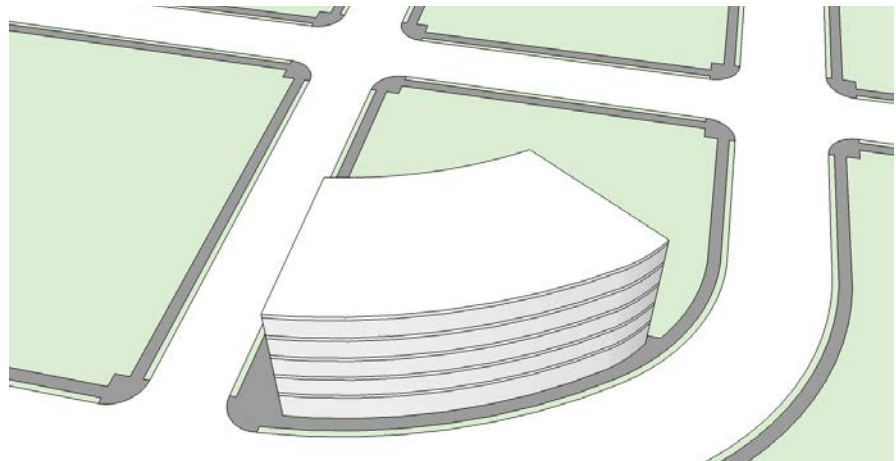

Sec. 5.2.3. Articulation

A. The following table indicates the standards for appropriate building articulation. Refer to the [Sec. 5.2.3.B](#) to determine the number of articulation techniques that must be used. The articulation standards do not apply in the Historic District.

| | | |
|---|--|---|
| <p>Base, Middle, Cap</p> <ul style="list-style-type: none"> › Expressed by horizontal moldings, cornices, fenestration, patterns and changes in materials. |  |  |
| <p>Horizontal Articulation</p> <ul style="list-style-type: none"> › Horizontal Molding: 2" min in depth and 6" min in height, full width of facade. › Alignment: upper-story windows, balconies, canopies and other architectural features in alignment with one another and the historic context, for the full width of facade › Cornice: 6" min in depth and 18" min in height, for the full width of facade. |  |  |
| <p>Vertical Articulation</p> <ul style="list-style-type: none"> › Roof Line Offset: 3' min height difference for at least 20% of facade width › Vertical Molding: 4" min in depth and 12" in width, full height of facade › Wall Notch: 4' min depth, 6' min width and full height of facade for at least 10% of facade width. |  |  |
| <p>Step Back</p> <ul style="list-style-type: none"> › 10' min step back from street facing facade plane for at least 20% of facade width. |  |  |
| <p>Material Variation</p> <ul style="list-style-type: none"> › Change in materials and their inherent colors, textures and finishes. |  |  |

Note: The images above are intended to illustrate the articulation techniques, the heights and other dimensions shown may not be allowed in some sub-districts.

B. The following table indicates the required number of articulation techniques that must be used based on the facade length facing a designated Frontage. Refer to the Sec. 5.2.3.A for standards for each articulation technique. The articulation standards do not apply in the Historic District

| | -----Facade Length----- | | |
|--|-------------------------|-----------|---------|
| | (< 50) | (50'-75') | (> 75') |
| Number of Required Articulation Techniques | 2 | 3 | 4 |
| Base, Middle, Cap | R | R | R |
| Horizontal Articulation | R | R | R |
| Vertical Articulation | O | O | R |
| Step Back | O | O | O |
| Material Variation | O | O | O |

R = Required O = Optional

Sec. 5.2.4. Building Materials

A. Primary and Secondary Building Materials











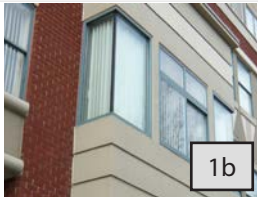

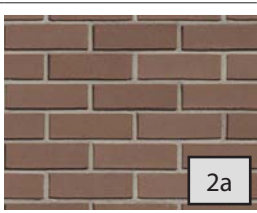
The following table indicates building materials that are appropriate as primary (P) or secondary (S) materials in each of the sub-districts. Secondary materials cannot exceed 25% of the surface area of any one building facade. These standards apply to the primary and secondary materials that are integral to the wall of a building. They do not limit use for accents or accessories such as storefronts, awnings or canopies.

| | Historic | | Transition | | | | | Edge | |
|--|----------|-----|------------|-----|-----|-----|-----|------|-----|
| | HSH | HCO | TMC | TNF | TNX | TSA | TNE | ENX | ECC |
| 1. Stucco | | | | | | | | | |
| a. Authentic | S | S | P/S | P/S | P/S | S | P/S | P/S | P/S |
| b. Synthetic (scored) | S | -- | S | P/S | S | S | P/S | S | P/S |
| c. Synthetic (not scored) | -- | -- | -- | S | S | -- | P/S | -- | S |
| 2. Masonry | | | | | | | | | |
| a. Brick | P/S | P/S | P/S | P/S | P/S | P/S | P/S | P/S | P/S |
| b. Stone | S | S | P/S | P/S | P/S | P/S | P/S | P/S | P/S |
| c. Patterned Pre-Cast Concrete | S | S | -- | -- | S | S | S | P/S | P/S |
| d. Cement Board Siding | S | S | -- | S | S | S | P/S | S | P/S |
| e. Terra Cotta & Ceramic Block | S | S | S | S | S | S | S | S | S |
| f. Detailed Concrete | -- | -- | S | S | S | S | S | S | S |
| g. Cast Stone | S | S | S | -- | S | S | S | S | S |
| h. Prefabricated Brick Panels | -- | -- | -- | -- | -- | -- | -- | S | S |
| 3. Siding | | | | | | | | | |
| a. Shingled | S | S | S | S | S | S | S | S | S |
| b. Horizontal Lap (Wood and Cement Board Siding) | S | S | -- | -- | S | S | -- | S | -- |
| c. Vertical Board and Batten | -- | -- | -- | -- | S | S | -- | S | -- |
| 4. Metal | | | | | | | | | |
| a. Metal Panels | S | S | S | S | S | S | P/S | P/S | P/S |

P = Allowed as a Primary Material S = Allowed as a Secondary Material -- = Material Not Allowed

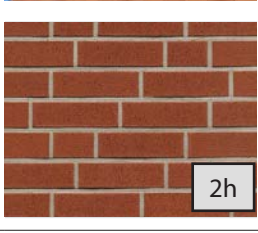
B. Building Material Images

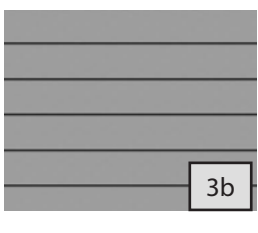
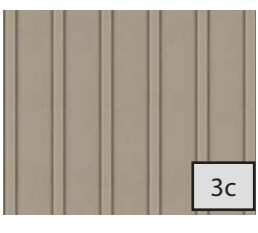
Primary and secondary building materials are illustrated below. Allowed building materials may be used individually or in combination. Examples of each type of material are shown below.

| | | | |
|---|---|--|---|
| <p>1. Stucco</p> <ul style="list-style-type: none"> a. Authentic b. Synthetic (scored) c. Synthetic (not scored) |  <p>1a</p> |  <p>1b</p> |  <p>1c</p> |
| <p>2. Masonry</p> <ul style="list-style-type: none"> a. Brick b. Stone c. Patterned Pre-Cast Concrete d. Cement Board Siding e. Terra Cotta & Ceramic Block f. Detailed Concrete g. Cast Stone h. Prefabricated Brick Panels |  <p>2a</p> |  <p>2b</p> |  <p>2c</p> |
| |  <p>2d</p> |  <p>2e</p> |  <p>2f</p> |
| |  <p>2g</p> |  <p>2h</p> | |
| <p>3. Siding</p> <ul style="list-style-type: none"> a. Shingled b. Horizontal Lap Board (Wood and Cement Board Siding) c. Vertical Board and Batten |  <p>3a</p> |  <p>3b</p> |  <p>3c</p> |
| <p>4. Metal</p> <ul style="list-style-type: none"> a. Metal Panels |  <p>4a</p> |  <p>4a</p> | |

ARTICLE 6. LAND USE PROVISIONS

| | |
|---|------|
| Div. 6.1. Permitted Uses..... | 6-2 |
| Sec. 6.1.1. Use Classification | 6-2 |
| Sec. 6.1.2. Allowed Use Table | 6-4 |
| Div. 6.2. Use Standards | 6-14 |
| Sec. 6.2.1. Multifamily Dwelling | 6-14 |
| Sec. 6.2.2. Drive-in Restaurant or Business | 6-14 |
| Sec. 6.2.3. Temporary Construction Facilities | 6-14 |
| Sec. 6.2.4. Mobile Vendors | 6-14 |

Div. 6.1. Permitted Uses

Sec. 6.1.1. Use Classification

A. Allowed Uses

Sec. 6.1.2 establishes allowed principal and accessory uses. No building or lot may be used except for a purpose permitted in the sub-district in which it is located. Uses not specifically listed must be approved by the FBC Administrator in accordance with Sec. 6.1.1.B.

B. Unlisted Uses

1. Principal Uses

- a. A principal use not specifically listed in Sec. 6.1.2 is prohibited. If a principal use is not listed then the FBC Administrator will, upon the request of any interested party, make a determination within which sub-district, if any, a proposed use is allowed.
- b. When determining whether a proposed use is similar to a listed use, the FBC Administrator will consider the following criteria:
 - i. The actual or projected characteristics of the proposed use;
 - ii. The relative amount of site area or floor area and equipment devoted to the proposed use;
 - iii. Relative amounts of sales;
 - iv. The customer type;
 - v. The relative number of employees;
 - vi. Hours of operation;
 - vii. Building and site arrangement;
 - viii. Types of vehicles used and their parking requirements;

- ix. The number of vehicle trips generated;
 - x. How the proposed use is advertised;
 - xi. The likely impact on surrounding properties; and
 - xii. Whether the activity is likely to be found independent of the other activities on the site.
- c. Where a use not listed is found by the FBC Administrator not to be similar to any other permitted use, the use can only be permitted following a text amendment.
- ##### 2. Accessory Uses

An accessory use not specifically listed in Sec. 6.1.2 is prohibited unless the FBC Administrator determines the accessory use:

- a. Is clearly incidental to and customarily found in connection with an allowed principal use;
- b. Is serving an allowed principal use;
- c. Is subordinate in area, extent and purpose to the principal use served;
- d. Contributes to the comfort, convenience or needs of occupants, business or industry in the principal use served; and
- e. Is located on the same lot as the principal use served.

C. Key to the Allowed Use Table

1. Permitted Uses (P)

A "P" in a cell indicates that a use is allowed by-right in the respective sub-district. Permitted uses are subject to all other applicable regulations of this Code and the City of Fort Worth Zoning Ordinance. A "P*" in any cell means that supplemental use standards apply. The specific section number of the supplemental standards are noted in the right-hand column, titled "Supplemental Use Standards."

2. Special Exception Required (SE)

An "SE" in a cell indicates that a use is allowed only if reviewed and approved as a special exception use in the respective sub-district, in accordance with the review procedures of Chapter 3, Article 3 of the City of Fort Worth Zoning Ordinance. An "SE*" in any cell means that supplemental standards use also apply. The specific section number of the supplemental standards are noted in the right-hand column, titled "Supplemental Use Standards."

3. Uses Not Allowed

A "--" indicates that a use is not allowed in the respective sub-district.

Sec. 6.1.2. Allowed Use Table

| | SY-HSH | SY-HCO | SY-TMC | SY-TNF | SY-TNX | SY-TNE | SY-TSA | SY-ENX | SY-ECC | Supplemental Use Standards |
|---|--------|--------|--------|--------|--------|--------|--------|--------|--------|---------------------------------|
| Residential Uses | | | | | | | | | | |
| Household Living | | | | | | | | | | |
| One-family detached dwelling | -- | -- | -- | -- | -- | -- | -- | -- | -- | |
| Two-family detached | -- | -- | -- | -- | -- | -- | -- | -- | -- | |
| Duplex/two-family attached dwelling | -- | -- | -- | -- | -- | -- | -- | -- | -- | |
| One-family attached (townhouse, rowhouse) | -- | -- | P | -- | P | P | P | P | P | |
| Multifamily dwelling | P* | -- | P | -- | P | P | P | P | P | Sec. 6.2.1 |
| One dwelling unit (when part of a business) | P | -- | P | -- | P | P | P | P | P | |
| Group Living | | | | | | | | | | |
| Boarding House | -- | -- | -- | -- | -- | -- | -- | -- | -- | |
| Community Home | -- | -- | -- | -- | P* | P* | P* | P* | P* | § 5.110 (City Zoning Ordinance) |
| Group Home I | -- | -- | -- | -- | P* | P* | P* | P* | P* | § 5.115 (City Zoning Ordinance) |
| Group Home II | -- | -- | -- | -- | P* | P* | P* | P* | P* | § 5.115 (City Zoning Ordinance) |
| Halfway House | -- | -- | -- | -- | -- | -- | -- | -- | -- | |
| Shelter | -- | -- | -- | -- | -- | -- | -- | -- | -- | |
| Public and Civic Uses | | | | | | | | | | |
| Education | | | | | | | | | | |
| College or University | -- | -- | -- | -- | -- | -- | -- | -- | -- | |
| Day Care Center (Child or Adult) | -- | -- | -- | -- | P* | P* | P* | P* | P* | § 5.111 (City Zoning Ordinance) |
| School, Elementary or Secondary (Public) | -- | -- | -- | -- | -- | P | P | P | -- | |
| School, Elementary or Secondary (Private) | -- | -- | -- | -- | -- | P | P | P | -- | |
| Business College or Commercial School | P | P | P | P | P | P | P | P | P | |
| Government | | | | | | | | | | |
| Animal Shelter | -- | -- | -- | -- | -- | -- | -- | -- | -- | |
| Correctional Facility | -- | -- | -- | -- | -- | -- | -- | -- | -- | |
| Government Maintenance Facility | -- | -- | -- | -- | -- | -- | -- | -- | -- | |
| Government Office Facility | P | P | P | P | P | P | P | P | P | |

P = Permitted P* = Permitted must also meet supplemental use standards SE = Special Exception Required
 SE* = Special Exception required and must also meet supplemental use standards -- = Not Permitted

| | SY-HSH | SY-HCO | SY-TMC | SY-TNF | SY-TNX | SY-TNE | SY-TSA | SY-ENX | SY-ECC | Supplemental Use Standards |
|--|--------|--------|--------|--------|--------|--------|--------|--------|--------|----------------------------|
| Government | | | | | | | | | | |
| Governmental Vehicle Storage/ Junkyard | -- | -- | -- | -- | -- | -- | -- | -- | -- | |
| Museum, Library or Fine Art Center | P | P | P | P | P | P | P | P | P | |
| Probation or Parole Office | -- | -- | -- | -- | -- | -- | -- | -- | P | |
| Health Care Facilities | | | | | | | | | | |
| Ambulance Dispatch Station | -- | -- | -- | -- | -- | -- | -- | -- | P | |
| Assisted Living Facility | -- | -- | -- | -- | P | P | P | P | P | |
| Blood Bank | -- | -- | -- | -- | -- | -- | -- | -- | P | |
| Care Facility | -- | -- | -- | -- | P | P | P | P | P | |
| Health Services Facility, including Doctor's or Medical Office | | | | | P | P | P | P | P | |
| Hospice | -- | -- | -- | -- | P | P | P | P | P | |
| Hospital | -- | -- | -- | -- | -- | -- | -- | -- | -- | |
| Massage Therapy and Spa | P | P | P | P | P | P | P | P | P | |
| Nursing Home (with Full Medical Services) | -- | -- | -- | -- | P | P | P | P | P | |
| Recreation | | | | | | | | | | |
| Center, Community Recreation or Welfare | -- | -- | -- | -- | P | P | P | P | P | |
| Center, Community Recreation or Welfare (private or non-profit) | -- | -- | -- | -- | P | P | P | P | P | |
| Country Club (private) | -- | -- | -- | -- | -- | -- | -- | -- | -- | |
| Country Club (public) | -- | -- | -- | -- | -- | -- | -- | -- | -- | |
| Golf Course | -- | -- | -- | -- | -- | -- | -- | -- | -- | |
| Golf Driving Range | -- | -- | -- | -- | -- | -- | -- | -- | -- | |
| Park or Playground (public or private) | P | P | P | P | P | P | P | P | P | |
| Religious | | | | | | | | | | |
| Place of Worship | P | P | P | P | P | P | P | P | P | |
| Place of Worship Auxiliary Use | P | P | P | P | P | P | P | P | P | |

P = Permitted P* = Permitted must also meet supplemental use standards SE = Special Exception Required
 SE* = Special Exception required and must also meet supplemental use standards -- = Not Permitted

| | SY-HSH | SY-HCO | SY-TMC | SY-TNF | SY-TNX | SY-TNE | SY-TSA | SY-ENX | SY-ECC | Supplemental Use Standards |
|---|--------|--------|--------|--------|--------|--------|--------|--------|--------|---------------------------------|
| Utilities | | | | | | | | | | |
| Electric Power Substation | -- | -- | -- | -- | SE | SE | SE | SE | SE | |
| Gas Lift Compressor Station | -- | -- | -- | -- | SE | SE | SE | SE | SE | Ch. 15, Gas City Code |
| Gas Line Compressor Station | -- | -- | -- | -- | SE | SE | SE | SE | SE | Ch. 15, Gas City Code |
| Power Plant or Central Station Light | -- | -- | -- | -- | -- | -- | -- | -- | -- | |
| Stealth Telecommunications Towers | -- | -- | -- | -- | SE* | SE* | SE* | SE* | SE* | § 5.137 (City Zoning Ordinance) |
| Telecommunications Antenna (on structure) | -- | SE* | SE* | SE* | SE* | SE* | SE* | SE* | SE* | § 5.133 (City Zoning Ordinance) |
| Telecommunications Tower | -- | -- | -- | -- | SE* | SE* | SE* | SE* | SE* | § 5.137 (City Zoning Ordinance) |
| Utility Transmission or Distribution Line | SE* | SE* | SE* | SE* | SE* | SE* | SE* | SE* | SE* | § 5.140 (City Zoning Ordinance) |
| Wastewater (Sewage) Treatment Facility | -- | -- | -- | -- | -- | -- | -- | -- | -- | |
| Water Supply, Treatment or Storage Facility | -- | -- | -- | -- | SE | SE | SE | SE | SE | |
| Commercial Uses | | | | | | | | | | |
| Entertainment and Eating | | | | | | | | | | |
| Amusement, Indoor | P | P | P | P | P | P | P | P | P | |
| Amusement, Outdoor | -- | -- | -- | -- | -- | -- | -- | -- | -- | |
| Baseball, Softball Facility (commercial) | -- | -- | -- | -- | -- | -- | -- | -- | -- | |
| Bar, Tavern, Cocktail Lounge; Club, Private or Teen | P | P | P | P | P | P | P | P | P | |
| Brewpub | P | P | P | P | P | P | P | P | P | |
| Circus | -- | -- | -- | P | -- | P | P | -- | -- | |
| Club, Commercial or Business | P | P | P | P | P | P | P | P | P | |
| Drive-In Restaurant or Business | -- | -- | -- | -- | -- | -- | -- | -- | P* | <u>Sec. 6.2.2</u> |
| Health or Recreation Club | P | P | P | P | P | P | P | P | P | |
| Indoor Recreation | P | P | P | P | P | P | P | P | P | |
| Lodge or Civic Club | P | P | P | P | P | P | P | P | P | |
| Museum/Cultural Facility | P | P | P | P | P | P | P | P | P | |
| Racing: Horse, Dog or Automotive | -- | -- | -- | -- | -- | -- | -- | -- | -- | |

P = Permitted P* = Permitted must also meet supplemental use standards SE = Special Exception Required
 SE* = Special Exception required and must also meet supplemental use standards -- = Not Permitted

| | SY-HSH | SY-HCO | SY-TMC | SY-TNF | SY-TNX | SY-TNE | SY-TSA | SY-ENX | SY-ECC | Supplemental Use Standards |
|---|--------|--------|--------|--------|--------|--------|--------|--------|--------|---------------------------------|
| Entertainment and Eating | | | | | | | | | | |
| Restaurant, Cafe, Cafeteria | P* | P* | P* | P* | P* | P* | P* | P* | P* | Chap 9, Restaurants |
| Sexually Oriented Business | -- | -- | -- | -- | -- | -- | -- | -- | -- | |
| Shooting or Weapons Firing Range | -- | -- | -- | -- | -- | -- | -- | -- | -- | |
| Stable, Commercial, Riding, Boarding or Rodeo Arena | P | P | P | P | -- | P | P | -- | -- | |
| Swimming Pool, Commercial | -- | -- | -- | -- | -- | -- | -- | -- | -- | |
| Theater, Drive-In | -- | -- | -- | -- | -- | -- | -- | -- | -- | |
| Theater, Movie Theater or Auditorium | P* | P* | P* | P* | P* | P* | P* | P* | P* | § 5.138 (City Zoning Ordinance) |
| Lodging | | | | | | | | | | |
| Bed and Breakfast Home | -- | -- | -- | -- | -- | -- | -- | -- | -- | |
| Bed and Breakfast Inn | P | P | P | P | P | P | P | P | P | |
| Hotel, Motel or Inn | P | P | P | P | P | P | P | P | P | |
| Office | | | | | | | | | | |
| Bank, Financial Institution | P | P | P | P | P | P | P | P | P | |
| Office | P | P | P | P | P | P | P | P | P | |
| Retail Sales and Service | | | | | | | | | | |
| Antique Shop | P | P | P | P | P | P | P | P | P | |
| Appliance, Sales, Supply or Repair | P | P | P | P | P | P | P | P | P | |
| Bakery | P | P | P | P | P | P | P | P | P | |
| Barber or Beauty Shop | P | P | P | P | P | P | P | P | P | |
| Book, Stationary Stores or Newsstand | P | P | P | P | P | P | P | P | P | |
| Burglar Alarm Sales and Service | P | P | P | P | P | P | P | P | P | |
| Caterer or Wedding Service | P | P | P | P | P | P | P | P | P | |
| Clothing/Wearing Apparel Sales, New | P | P | P | P | P | P | P | P | P | |
| Clothing/Wearing Apparel Sales, Used | P | P | P | P | P | P | P | P | P | |
| Convenience Store | P | P | P | P | P | P | P | P | P | |
| Copy Store or Commercial Print Without Off-Set Printing | P | P | P | P | P | P | P | P | P | |
| Retail Sales and Service | | | | | | | | | | |

P = Permitted P* = Permitted must also meet supplemental use standards SE = Special Exception Required
 SE* = Special Exception required and must also meet supplemental use standards -- = Not Permitted

| | SY-HSH | SY-HCO | SY-TMC | SY-TNF | SY-TNX | SY-TNE | SY-TSA | SY-ENX | SY-ECC | Supplemental Use Standards |
|---|--------|--------|--------|--------|--------|--------|--------|--------|--------|---------------------------------|
| Dance Studio | P | P | P | P | P | P | P | P | P | |
| Dressmaking, Custom; Millinery Shop | P | P | P | P | P | P | P | P | P | |
| Duplicating Services | P | P | P | P | P | P | P | P | P | |
| Farmer's Market | P | P | P | P | P | P | P | P | P | |
| Feed Store, No Processing/Milling | P | P | P | P | P | P | P | P | P | |
| Firewood Sales | P* | P* | P* | P* | P* | P* | P* | P* | P* | § 5.113 (City Zoning Ordinance) |
| Furniture Sales in a Building (new/used) | P | P | P | P | P | P | P | P | P | |
| Furniture Sales with Outside Storage/Display (new/used) | -- | P | P | P | -- | P | -- | -- | P | |
| Furniture Upholstery, Refinishing or Resale | P | P | P | P | P | P | P | P | P | |
| General Merchandise Store | P | P | P | P | P | P | P | P | P | |
| Greenhouse or Plant Nursery | -- | -- | -- | -- | P | P | P | P | P | |
| Grocery Store, Meat Market | P | P | P | P | P | P | P | P | P | |
| Gunsmithing, Repair or Sales | P | P | P | P | P | P | P | P | P | |
| Home Improvement Sales | P | P | P | P | P | P | P | P | P | |
| Interior Decorating | P | P | P | P | P | P | P | P | P | |
| Laundry or Dry Cleaning Collection Office | -- | -- | -- | -- | P | P | P | P | P | |
| Laundry, Dry Cleaning or Washeteria | -- | -- | -- | -- | P | P | P | P | P | |
| Leather Goods Shop | P | P | P | P | P | P | P | P | P | |
| Liquor or Package Store | P | P | P | P | P | P | P | P | P | |
| Livestock Auction | P | P | P | P | -- | P | P | -- | -- | |
| Locksmith | P | P | P | P | P | P | P | P | P | |
| Medical Supplies/Equipment Sales | P | P | P | P | P | P | P | P | P | |
| Mini-Warehouse | -- | -- | -- | -- | -- | -- | -- | -- | -- | |
| Mortuary or Funeral Home | P | P | P | P | P | P | P | P | P | |
| Newspaper Distribution Center | -- | -- | -- | -- | -- | -- | -- | -- | -- | |
| Optician | P | P | P | P | P | P | P | P | P | |
| Retail Sales and Service | | | | | | | | | | |

P = Permitted P* = Permitted must also meet supplemental use standards SE = Special Exception Required
 SE* = Special Exception required and must also meet supplemental use standards -- = Not Permitted

| | SY-HSH | SY-HCO | SY-TMC | SY-TNF | SY-TNX | SY-TNE | SY-TSA | SY-ENX | SY-ECC | Supplemental Use Standards |
|--|--------|--------|--------|--------|--------|--------|--------|--------|--------|---------------------------------|
| Pawn Shop | -- | -- | -- | -- | -- | -- | -- | -- | P | |
| Pharmacy (Drug Store) | P | P | P | P | P | P | P | P | P | |
| Photograph, Portrait/Camera Shop or Photo Finishing | P | P | P | P | P | P | P | P | P | |
| Recording Studio | P* | P* | P* | P* | P* | P* | P* | P* | P* | § 5.128 (City Zoning Ordinance) |
| Retail Sales, General | P | P | P | P | P | P | P | P | P | |
| Saddle or Harness, Repair or Sales | P | P | P | P | P | P | P | P | P | |
| Shoe Shine Shop | P | P | P | P | P | P | P | P | P | |
| Studio, Art or Photography | P | P | P | P | P | P | P | P | P | |
| Tailor, Clothing or Apparel Shop | P | P | P | P | P | P | P | P | P | |
| Tattoo Parlor | P | P | P | P | P | P | P | P | P | |
| Taxidermist Shop | P | P | P | P | P | P | P | P | P | |
| Veterinary Clinic w/Indoor Kennels | -- | P | P | P | P | P | P | P | P* | § 5.142 (City Zoning Ordinance) |
| Veterinary Clinic w/Outdoor Kennels | -- | P | P | P | -- | P | P | -- | P | |
| Vehicle Sales and Service | | | | | | | | | | |
| Auto Parts Supply, Retail | -- | -- | -- | -- | -- | -- | -- | -- | P | |
| Automotive Repair; Paint and Body Shop | -- | -- | -- | -- | -- | -- | -- | -- | -- | |
| Car Wash, Full or Self-Service | -- | -- | -- | -- | -- | -- | -- | -- | P | |
| Gasoline Sales | -- | -- | -- | -- | -- | -- | -- | -- | P | |
| Mobile Home or Manufactured Housing Sales | -- | -- | -- | -- | -- | -- | -- | -- | -- | |
| Recreational Vehicle (RV) Sales/ Service | -- | -- | -- | -- | -- | -- | -- | -- | -- | |
| Service Station | -- | -- | -- | -- | -- | -- | -- | -- | -- | |
| Towing Yard w/ Office | -- | -- | -- | -- | -- | -- | -- | -- | -- | |
| Truck Stop w/ Fuel and Accessory Services | -- | -- | -- | -- | -- | -- | -- | -- | -- | |
| Vehicle Junkyard | -- | -- | -- | -- | -- | -- | -- | -- | -- | |
| Vehicle Sales or Rental Showrooms or Kiosks; Including Automobiles, Motorcycles, Boats or Trailers | -- | -- | P | P | -- | P | P | -- | P | |
| Vehicle Steam Cleaning | -- | -- | -- | -- | -- | -- | -- | -- | P | |
| Light Industrial Uses | | | | | | | | | | |

P = Permitted P* = Permitted must also meet supplemental use standards SE = Special Exception Required
 SE* = Special Exception required and must also meet supplemental use standards -- = Not Permitted

| | SY-HSH | SY-HCO | SY-TMC | SY-TNF | SY-TNX | SY-TNE | SY-TSA | SY-ENX | SY-ECC | Supplemental Use Standards |
|--|--------|--------|--------|--------|--------|--------|--------|--------|--------|----------------------------|
| Light Industrial Services | | | | | | | | | | |
| Assaying | -- | -- | -- | -- | -- | -- | -- | -- | -- | |
| Assembly of Pre-Manufactured Parts, Except for Vehicles, Trailers, Airplanes or Mobile Homes | -- | -- | -- | -- | -- | -- | -- | -- | -- | |
| Bottling Works, Milk or Soft Drinks | -- | -- | -- | -- | -- | -- | -- | -- | -- | |
| Blacksmithing or Wagon Shop | P | P | P | P | P | P | P | P | P | |
| Brewery, Distillery or Winery | P | P | P | P | P | P | P | P | P | |
| Carpet and Rug Cleaning | -- | -- | -- | -- | -- | -- | -- | -- | -- | |
| Chicken Battery or Brooder | -- | -- | -- | -- | -- | -- | -- | -- | -- | |
| Coal, Coke or Wood Yard | -- | -- | -- | -- | -- | -- | -- | -- | -- | |
| Cottage Manufacturing Uses | P | P | P | P | P | P | P | P | P | |
| Crematorium | -- | -- | -- | -- | -- | -- | -- | -- | -- | |
| Electroplating | -- | -- | -- | -- | -- | -- | -- | -- | -- | |
| Fabricating of Manufactured Housing, Temporary or Office Building | -- | -- | -- | -- | -- | -- | -- | -- | -- | |
| Food Processing (no slaughtering) | P | P | P | P | P | P | P | P | P | |
| Galvanizing, Small Utensils | -- | -- | -- | -- | -- | -- | -- | -- | -- | |
| Machine Shops | -- | -- | -- | -- | -- | -- | -- | -- | -- | |
| Manufacture of Artificial Flowers, Ornaments, Awnings, Tents, Bags, Cleaning/Polishing Preparations, Boats Under 28' | -- | -- | -- | -- | -- | -- | -- | -- | -- | |
| Manufacture of Aluminum, Brass or Others Metals or from Bone, Paper, Rubber, leather | -- | -- | -- | -- | -- | -- | -- | -- | -- | |
| Manufacture of Basket Material, Bicycles, Boots/Shoes, Boxes, Caskets | -- | P | P | P | -- | P | P | -- | P | |
| Manufactured Home/RV Repair | -- | -- | -- | -- | -- | -- | -- | -- | -- | |
| Monument/Marble Works, Finishing and Carving Only | -- | P | P | P | -- | P | P | -- | P | |

P = Permitted P* = Permitted must also meet supplemental use standards SE = Special Exception Required
 SE* = Special Exception required and must also meet supplemental use standards -- = Not Permitted

| | SY-HSH | SY-HCO | SY-TMC | SY-TNF | SY-TNX | SY-TNE | SY-TSA | SY-ENX | SY-ECC | Supplemental Use Standards |
|---|--------|--------|--------|--------|--------|--------|--------|--------|--------|----------------------------|
| Light Industrial Services | | | | | | | | | | |
| Monument Works, Stone | -- | P | P | P | -- | P | P | -- | P | |
| Paint Mixing or Spraying | -- | -- | -- | -- | -- | -- | -- | -- | -- | |
| Paper Box Manufacture | -- | -- | -- | -- | -- | -- | -- | -- | -- | |
| Pattern Shop | -- | P | P | P | -- | P | P | -- | P | |
| Printing, Lithographing, Book-Binding, Newspapers or Publishing | -- | P | P | P | -- | P | P | -- | P | |
| Rubber Stamping, Shearing/Punching | -- | P | P | P | -- | P | P | -- | P | |
| Rubber Stamp Manufacture | -- | -- | -- | -- | -- | -- | -- | -- | -- | |
| Sheet Metal Shop | -- | -- | -- | -- | -- | -- | -- | -- | -- | |
| Warehouse or Bulk Storage | P | P | P | P | P | P | P | P | P | |
| Welding Shop, Custom Work (not structural) | -- | P | P | P | -- | P | P | -- | P | |
| Yards, Contractors, Lumber or Storage, Automobiles, Storage Yards, Building Materials | -- | -- | -- | -- | -- | -- | -- | -- | -- | |
| Heavy Industrial Uses | | | | | | | | | | |
| All Heavy Industrial Manufacturing | -- | -- | -- | -- | -- | -- | -- | -- | -- | |
| Transportation | | | | | | | | | | |
| Airport, Aviation Field, Helistop or Landing Area | -- | -- | -- | -- | -- | -- | -- | -- | -- | |
| Passenger Station | -- | P | P | P | -- | P | P | -- | -- | |
| Railroad Freight or Classification Yard | -- | -- | -- | -- | -- | -- | -- | -- | -- | |
| Railroad Roundhouse or Railroad Car Repair Shop | -- | P | -- | P | -- | -- | -- | -- | -- | |
| Railroad Tracks, Team, Spur or Storage | -- | P | P | P | -- | P | P | -- | -- | |
| Terminal: Truck, Freight, Rail or Water | -- | -- | -- | -- | -- | -- | -- | -- | -- | |

P = Permitted P* = Permitted must also meet supplemental use standards SE = Special Exception Required
 SE* = Special Exception required and must also meet supplemental use standards -- = Not Permitted

| | SY-HSH | SY-HCO | SY-TMC | SY-TNF | SY-TNX | SY-TNE | SY-TSA | SY-ENX | SY-ECC | Supplemental Use Standards |
|--|--------|--------|--------|--------|--------|--------|--------|--------|--------|----------------------------------|
| Waste Related | | | | | | | | | | |
| Landfill, Recycling Center, Household Hazardous Waste or Waste Tire Facility | -- | -- | -- | -- | -- | -- | -- | -- | -- | |
| Pet Cemetery | -- | -- | -- | -- | -- | -- | -- | -- | -- | |
| Recycling Collection Facility | -- | -- | -- | -- | -- | -- | -- | -- | SE* | § 5.130 (City Zoning Ordinance) |
| Salvage Yard (other than automotive) | -- | -- | -- | -- | -- | -- | -- | -- | -- | |
| Wholesale Trade | | | | | | | | | | |
| Wholesale: Bakery, Produce Market or Wholesale House | P | P | P | P | P | P | P | P | P | |
| Wholesale Office or Sample Room | -- | -- | -- | -- | -- | -- | -- | -- | P | |
| Other Uses | | | | | | | | | | |
| Agricultures | | | | | | | | | | |
| Agricultural Uses | -- | P | P | P | -- | P | P | -- | -- | |
| Community Garden | -- | -- | P | P | P | P | P | P | P | |
| Stockyards or Feeding Pens (commercial/noncommercial) | -- | P | P | P | -- | P | P | -- | -- | |
| Fresh Water Fracture Ponds and Production | -- | -- | -- | -- | -- | -- | -- | -- | -- | |
| Gas Drilling and Production | -- | -- | P* | P* | P* | P* | P* | P* | P* | Ch. 15, Gas City Code |
| Oil Drilling and Production | -- | -- | -- | -- | -- | -- | -- | -- | -- | |
| Accessory Uses | | | | | | | | | | |
| Accessory Use or Building | P | P | P | P | P | P | P | P | P | |
| Home Occupation | P* | -- | P* | -- | P* | P* | P* | P* | P* | § 5.116A (City Zoning Ordinance) |
| Outdoor Display | P* | P* | P* | P* | P* | P* | P* | P* | P* | Sec. 7.5.2 |
| Limited Outdoor Storage | P* | P* | P* | P* | P* | P* | P* | P* | P* | Sec. 7.5.3 |
| General Outdoor Storage | -- | -- | -- | -- | -- | -- | -- | -- | -- | Sec. 7.5.4 |
| Satellite Antenna (dish) | P | P | P | P | P | P | P | P | P | |
| Solar Energy Equipment | P | P | P | P | P | P | P | P | P | |
| Wind Energy Equipment | P | P | P | P | P | P | P | P | P | |
| Rain Water Harvesting Equipment | P | P | P | P | P | P | P | P | P | |
| Utility Equipment (includes electrical transformers, gas meters, etc.) | P | P | P | P | P | P | P | P | P | |

P = Permitted P* = Permitted must also meet supplemental use standards SE = Special Exception Required

SE* = Special Exception required and must also meet supplemental use standards -- = Not Permitted

| | SY-HSH | SY-HCO | SY-TMC | SY-TNF | SY-TNX | SY-TNE | SY-TSA | SY-ENX | SY-ECC | Supplemental Use Standards |
|---|--------|--------|--------|--------|--------|--------|--------|--------|--------|---------------------------------|
| Recreational Vehicle Park | -- | -- | P | P | -- | P | P | -- | -- | |
| Temporary Uses | | | | | | | | | | |
| Amusement, Outdoor | SE* | SE* | SE* | SE* | SE* | SE* | SE* | SE* | SE* | § 5.400 (City Zoning Ordinance) |
| Batch Plant, Concrete or Asphalt | -- | -- | -- | -- | -- | -- | -- | -- | -- | |
| Garage or Other Occasional Sale | P | -- | P | -- | P | P | P | P | P | |
| Model Home | -- | -- | -- | -- | -- | -- | -- | -- | -- | |
| Residence for Security Purposes | SE* | SE* | SE* | SE* | SE* | SE* | SE* | SE* | SE* | § 5.404 (City Zoning Ordinance) |
| Special Event (subject to City's special events ordinance) | P | P | P | P | P | P | P | P | P | |
| Temporary construction offices, storage sheds, trailers, barricades, fences | P* | P* | P* | P* | P* | P* | P* | P* | P* | <u>Sec. 6.2.3</u> |
| Trailer, Portable, Sales or Storage | P | P | P | P | P | P | P | P | P | |
| Vendor, Food, Mobile Food Court | P* | P* | P* | P* | P* | P* | P* | P* | P* | <u>Sec. 6.2.4</u> |
| Vendor, Merchandise | P* | P* | P* | P* | P* | P* | P* | P* | P* | <u>Sec. 6.2.4</u> |
| Vendor, Transient | P* | P* | P* | P* | P* | P* | P* | P* | P* | <u>Sec. 6.2.4</u> |
| Sales from Kiosks | P | P | P | P | P | P | P | P | P | |

P = Permitted P* = Permitted must also meet supplemental use standards SE = Special Exception Required
 SE* = Special Exception required and must also meet supplemental use standards -- = Not Permitted

Div. 6.2. Use Standards

Sec. 6.2.1. Multifamily Dwelling

A multifamily dwelling is only allowed in the upper stories of a building. A lobby or other entrance is allowed on the ground floor.

Sec. 6.2.2. Drive-in Restaurant or Business

- A. Adequate space must be made available on-site for the stacking, storage and queuing of vehicle.
- B. Where allowed, vehicles using drive-in or drive-thru facilities may not encroach on or interfere with the public use of streets and sidewalks by vehicles or pedestrians.
- C. All drive-thru, including but not limited to menu boards, stacking lanes, trash receptacles, ordering box, drive up windows, and other objects associated with the drive-thru, must be located to the side or rear of the building. Drive-thru windows and lanes may not be placed between a public street (not including an alley) and the associated building.

Sec. 6.2.3. Temporary Construction Facilities

- A. Temporary construction offices, storage sheds, trailers, barricades and fences will be allowed as necessary during the construction or restoration of buildings.
- B. Facilities must be placed as inconspicuously as possible.
- C. Construction fences must ensure the safety of pedestrians and motorists. Screening designs should have elements or references to the associated building under construction, with the exception of art project on the construction fence.
- D. It is not permitted to advertise for any off-site or non-property related entity (e.g., general contractor, financial institution).
- E. Off-site construction storage and construction trailers must meet the following:

- 1. Any plans for off-site storage of construction materials or construction trailers for new construction projects must be included with construction plans.
- 2. Construction trailers must be located within the designated limits of construction.
- 3. Sites used of off-site construction materials or construction trailers must be cleared before any issuance of a certificate of occupancy.
- 4. Off-site construction trailers will be limited to cases where site characteristic make it difficult or impractical to locate a trailer on the construction site.
- F. The Historic & Cultural Landmarks Commission will review plans for projects located in the Historic District and the Urban Design Commission will review plans for sites in the Transition and Edge Districts.

Sec. 6.2.4. Mobile Vendors

The requirements of § 5.406 of the City of Fort Worth Zoning Ordinance apply, except as listed below:

- A. § 5.406.C.3.
- B. § 5.406.C.4.
- C. § 5.406.C.13.
- D. § 5.406.D.1.
- E. § 5.406.D.2.
- F. § 5.406.F.1.e. is replaced as follows:

Restrooms must be provided within the boundaries of the Mobile Vendor Food Court. At least 1 restroom must be provided for each Mobile Vending Unit.
- G. § 5.406.F.2.
- H. § 5.406.F.3.
- I. § 5.406.F.5.
- J. § 5.406.F.6.
- K. § 5.406.F.7.

ARTICLE 7. SITE STANDARDS

| | |
|--|------|
| Div. 7.1. Parking and Access..... | 7-2 |
| Sec. 7.1.1. Pedestrian Access | 7-2 |
| Sec. 7.1.2. Vehicle Parking | 7-2 |
| Sec. 7.1.3. Bicycle Parking | 7-2 |
| Sec. 7.1.4. Location of Vehicle Parking | 7-2 |
| Sec. 7.1.5. Parking Setbacks | 7-3 |
| Sec. 7.1.6. Parking Structure Screening | 7-3 |
| Sec. 7.1.7. Residential Garages | 7-4 |
| Sec. 7.1.8. Vehicle Loading | 7-4 |
| Div. 7.2. Landscaping | 7-5 |
| Sec. 7.2.1. Parking Lots | 7-5 |
| Sec. 7.2.2. Plant Material | 7-6 |
| Sec. 7.2.3. Screening | 7-7 |
| Sec. 7.2.4. Walls and Fences | 7-8 |
| Div. 7.3. Site Lighting | 7-9 |
| Sec. 7.3.1. Applicability | 7-9 |
| Sec. 7.3.2. Lighting Standards | 7-9 |
| Div. 7.4. Signs | 7-13 |
| Sec. 7.4.1. Applicability | 7-13 |
| Sec. 7.4.2. Sign Types Allowed By District | 7-13 |
| Sec. 7.4.3. Sign Placement | 7-14 |
| Sec. 7.4.4. Sign Allocation | 7-14 |
| Sec. 7.4.5. A-Frame Sign | 7-15 |
| Sec. 7.4.6. Awning Sign | 7-16 |
| Sec. 7.4.7. Canopy Sign | 7-17 |
| Sec. 7.4.8. Crown Sign | 7-18 |
| Sec. 7.4.9. Monument Sign | 7-19 |
| Sec. 7.4.10. Projecting Sign | 7-20 |
| Sec. 7.4.11. Ranch Entrance Sign | 7-21 |
| Sec. 7.4.12. Shingle Sign | 7-22 |
| Sec. 7.4.13. Wall Sign | 7-23 |
| Sec. 7.4.14. Window Sign | 7-24 |
| Sec. 7.4.15. Illumination | 7-25 |
| Div. 7.5. Outdoor Display and Storage..... | 7-27 |
| Sec. 7.5.1. Applicability | 7-27 |
| Sec. 7.5.2. Outdoor Display | 7-27 |
| Sec. 7.5.3. Limited Outdoor Storage | 7-27 |
| Sec. 7.5.4. General Outdoor Storage | 7-27 |

Div. 7.1. Parking and Access

Sec. 7.1.1. Pedestrian Access

A. Access Required

All development must provide safe, direct and convenient pedestrian access connecting public streets and parking lots to primary building entrances, and to all other uses in the development that allow for public access.

B. Pedestrian Facilities

1. Pedestrian access must consist of an accessible, easily discernible, well-lit, and ADA compliant walkway a minimum of 5 feet in width.
2. The pedestrian access surface located on private property must be paved with fixed, non-slip semi-pervious or impervious materials.
3. Pedestrian access routes between buildings and parking areas must be physically separated from drive aisles, except when crossing a drive aisle.
4. Where a pedestrian walkway crosses a drive aisle, the walkway must have a continuous surface treatment across the drive aisle.

Sec. 7.1.2. Vehicle Parking

Vehicle parking spaces must be provided in accordance with § 6.201, Off-Street Parking Requirements, of the City of Fort Worth Zoning Ordinance.

Sec. 7.1.3. Bicycle Parking

Bike parking spaces must be provided in accordance with § 6.204, Bicycle Parking, of the City of Fort Worth Zoning Ordinance.

Sec. 7.1.4. Location of Vehicle Parking

Required vehicle parking must be located on the same lot as the use they are intended to serve, except as listed below.

A. On-Street Parking

1. One on-street parking space may be substituted for every required parking space, provided the on-street space is located on a public right-of-way immediately abutting the subject property. On-street parking spaces do not count towards the parking maximum.
2. Each on-street parking space may only be counted for one property. Where a space straddles an extension of a property line, the space may only be counted by the owner whose property abuts 50% or more of the on-street parking space.

B. Remote Parking

1. All required parking spaces, except required accessible spaces, can be located off site if the remote parking area is located within 500 feet from the primary entrance of the use served.
2. Up to 50% of the required parking spaces may be located more than 500 feet off site, if the parking area is located within 1,320 feet from the primary entrance of the use served.
3. All remote parking spaces used to meet the vehicle parking requirement must be located within the boundaries of the Stockyards Form District.
4. The distance of the off-site parking area is measured in walking distance from the nearest point of the off-site parking area to the primary entrance of the use served.
5. All off-site parking areas must have a City-approved remote parking agreement as part of the approved site plan.

Sec. 7.1.5. Parking Setbacks

A. General

1. The parking setback applies to that portion of the lot that fronts a designated Frontage.
2. All parking spaces must be located behind the parking setback line (surface and structured).
3. Parking below and covered by the ground may encroach into a required parking setback but cannot extend into a required easement or the right-of-way.
4. The parking setback is measured perpendicular from the lot line inward.

B. Historic Districts

The parking setback applies to all surface parking and the ground and upper stories of all buildings.

C. Transition Districts

1. The parking setback applies to all surface parking and the ground stories of all buildings.
2. Parking spaces on upper stories that face a designated Frontage must be screened in accordance with [Sec. 7.1.6.](#)

D. Edge Districts

1. The parking setback applies to all surface parking and the ground stories of all buildings.
2. Parking spaces on upper stories that face a designated Frontage must be screened in accordance with [Sec. 7.1.6.](#)

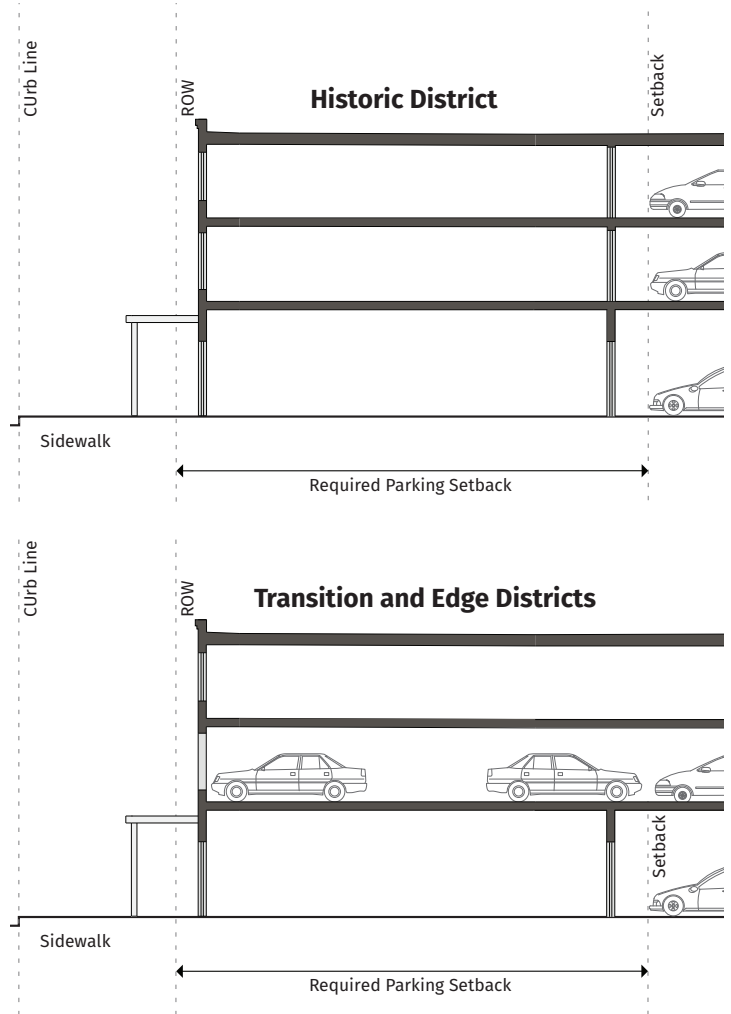

Sec. 7.1.6. Parking Structure Screening

- A. Where upper stories of structured parking are located at the perimeter of a building facing a designated Frontage they must be screened to hide park and shield lighting with glazing, metal grillwork, louvers, vegetation or another type of architectural treatment.
- B. Sloped ramps cannot be discernible along the perimeter of the parking structure.
- C. The ground floor facade treatment (building materials, windows and architectural detailing) must continued on upper stories.

Sec. 7.1.7. Residential Garages

- A. Residential garages must be placed entirely to the rear of the unit and be rear-accessed. The garage can be attached or detached.
- B. All garage doors must face a rear alley or rear access drive.

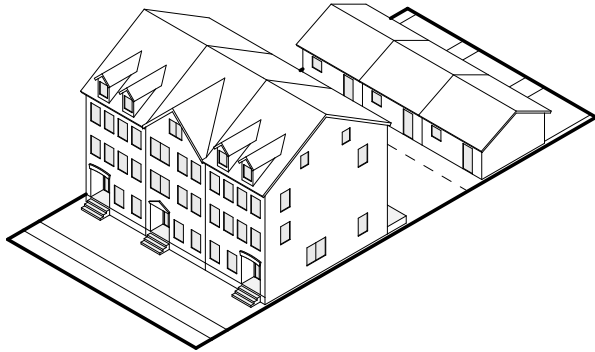

- 3. Loading areas may not be placed between a public street (not including an alley) and the associated building.
- 4. Loading areas must be located to the rear of buildings Screening?.
- 5. No designated loading area is allowed within 50 feet of a ground floor residential use (measured from the residential lot line to the closest point of the loading area).

Sec. 7.1.8. Vehicle Loading

A. Applicability

If determined necessary by the FBC Administrator, adequate space must be made available on-site for the unloading and loading of goods, materials, items or stock for delivery and shipping, otherwise on-site loading space is not required.

B. Location

If a loading area is provided or required, it must meet the following.

- 1. With the exception of areas specifically designated by the City, loading and unloading activities are not permitted on a public street, not including an alley.
- 2. Loading and unloading activities may not encroach on or interfere with the use of sidewalks, drive aisles, stacking areas and parking areas.

Div. 7.2. Landscaping

Sec. 7.2.1. Parking Lots

A. Applicability

Parking lot landscaping is required for all on-site surface vehicle parking areas with more than 10 spaces. Multiple platted lots contained on a single site plan, under one owner or development entity, and any separate parking areas connected with drive aisles are considered a single parking area.

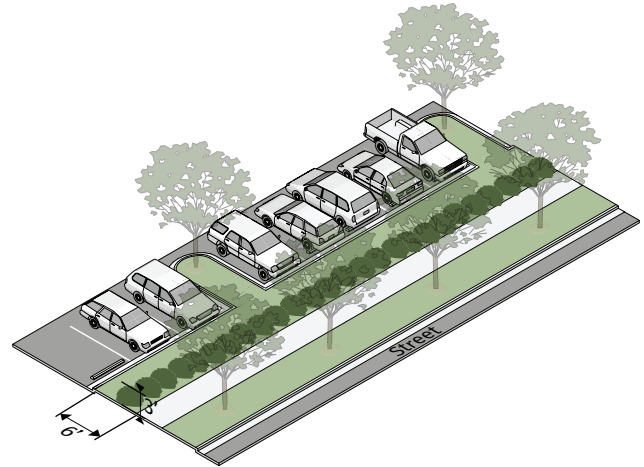
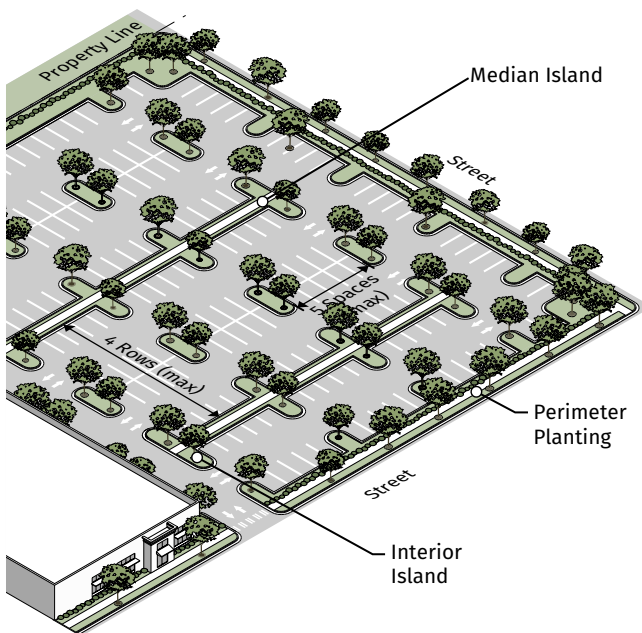

- i. All required shrubs must be of a species that under typical conditions are expected to reach a minimum height and spread of 3 feet within 3 years of planting. All shrubs must be a minimum of 2 feet tall when planted.
- ii. All required shrubs must form at least one continuous row of shrubs.
- iii. All perimeter screening shall not exceed four (4) feet in height.

2. Perimeter Planting with Wall

A minimum 4-foot wide landscape strip with a 3-foot high wall.

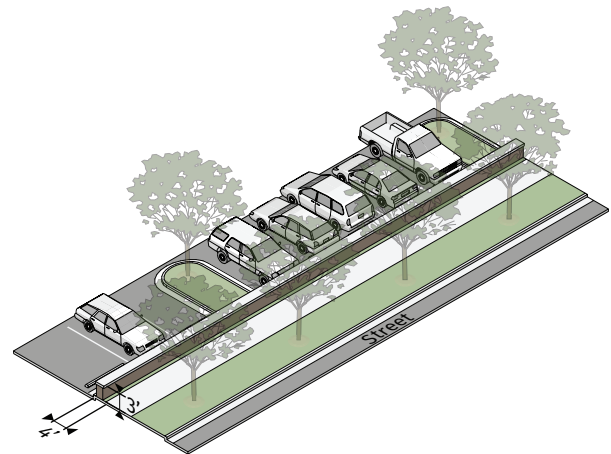

B. Trees in Surface Parking Lots

All new construction projects shall provide at least 40% tree canopy coverage of surface parking lots.

C. Perimeter Planting

One of the following perimeters screen is required along the outer perimeter of all parking areas (of any size) abutting a public or private street (not including an alley), excluding breaks for pedestrians, bicycles and driveways.

1. Perimeter Planting with Shrubs

- a. A minimum 6-foot wide landscape strip planted with 3-foot high continuous row of shrubs.

D. Curbing

All curbing must have openings to allow drainage to enter and percolate through landscaped areas.

Sec. 7.2.2. Plant Material

A. General Provisions

1. An automatic irrigation system is required in all landscape areas, and must be installed prior to plant of landscape materials.
2. No artificial plants, trees, or other vegetation may be installed as required landscaping.
3. Native or locally-adapted plants and species are preferred.
4. Required landscaping must be installed for full root contact with the surrounding subgrade. Planters planted on paved surfaces are not permitted.
5. Shrubs cannot be planted within the critical root zone of any tree.

B. Large Canopy Trees

1. Large canopy trees must be selected from § 6.302 Table F. Preferred Tree List (City of Fort Worth Zoning Ordinance).
2. Large canopy trees planted to meet the street tree or parking lot landscaping requirements must have a minimum caliper of 3 inches and have a 6-foot clear trunk before branching.

C. Small and Medium Canopy Trees

1. Small and medium canopy trees must be selected from § 6.302 Table F. Preferred Tree List (City of Fort Worth Zoning Ordinance).
2. Small and medium canopy single-stem trees planted to meet the street tree or parking lot landscaping requirements must have a minimum caliper of 2 inches and have a 5-foot clear trunk before branching.

3. Small and medium canopy multi-stem trees planted to meet the street tree or parking lot landscaping requirements must have a minimum caliper of 2½ inches and have a 5-foot clear trunk before branching.

Sec. 7.2.3. Screening

A. Service Areas

1. Trash and recycling collection and other similar service areas must be located to the rear of buildings.
2. Service areas must be screened on 3 sides by a wall a minimum 6 feet in height or to the top of the equipment, whichever is higher up to 8 feet maximum and on the 4th side by a solid gate at a minimum of 6 feet in height.

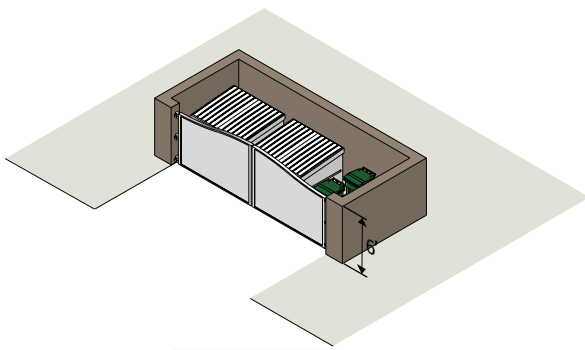

3. The gate and wall must be maintained in good working order and must remain closed except when trash pick-ups occur.
4. Trash and recycling collection and other similar service areas must be located on a concrete base.

B. Wall-Mounted Equipment

1. When feasible, wall-mounted equipment, not including antennas, must be located on non-street-facing building facades or structures.
2. Wall-mounted equipment, not including antennas, located on any building facade or structure that is visible from a private or public street (not including an alley) must be fully screened by landscaping or an opaque wall or fence that is compatible with the principal building in terms of texture, quality, material and color.

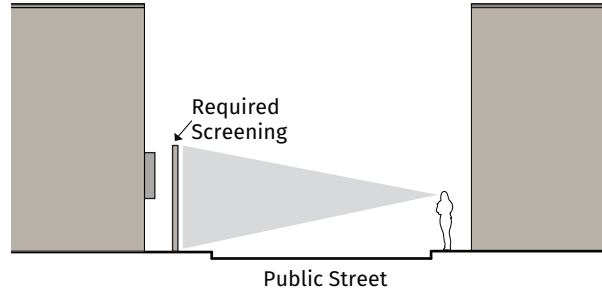

3. Screening must be of a height equal to the height of the mechanical equipment being screened.

C. Ground-Mounted Equipment

1. Ground-mounted mechanical equipment must be located to the rear of buildings.
2. Ground-mounted mechanical equipment above 30 inches in height that is visible from a public street (not including an alley) must be fully screened by landscaping or an opaque wall or fence that is compatible with the principal building in terms of texture, quality, material and color.

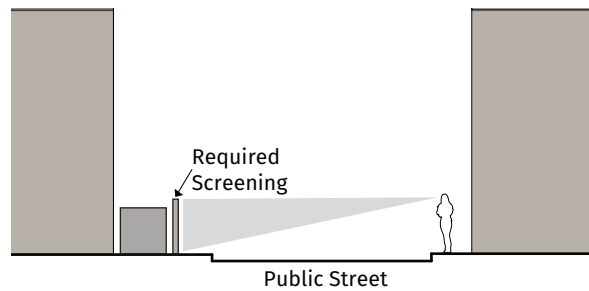

3. Screening must be of a height equal to or greater than the height of the mechanical equipment being screened.

D. Roof-Mounted Equipment

1. Roof-mounted equipment must be set back at least 10 feet from the edge of the roof and screened from ground level view from abutting property or abutting private or public street (not including an alley).

2. New buildings must provide a parapet wall up to 6 feet in height or other architectural element that is compatible with the principal building in terms of texture, quality, material and color that fully screens roof-mounted equipment from ground level view.

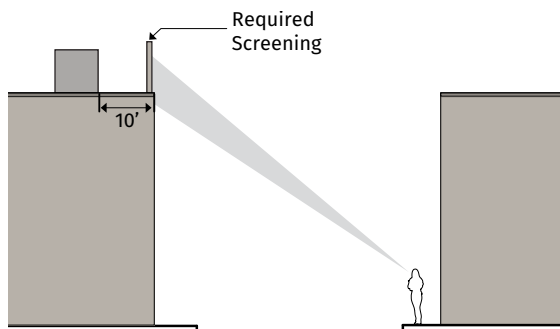

3. For buildings with no or low parapet walls, roof-mounted equipment must be screened on all sides by an opaque screen compatible with the principal building in terms of texture, quality, material and color.

Sec. 7.2.4. Walls and Fences

A. Materials

1. Walls must be constructed of high quality materials including decorative blocks, brick, stone, cast-stone, split-faced block, stucco over standard concrete masonry blocks, glass block; or other material approved by the FBC Administrator.
2. Fences must be constructed of high quality materials including; wood, wrought iron; composite fencing; aluminum; metal; or other material approved by the FBC Administrator.
3. No wall or fence may be constructed of tires, junk, or other discarded materials.
4. Chain-link fence, barbed wire or concertina wire is not allowed.

B. Location

1. Walls and fences may be located on the lot line.
2. No wall or fence may be located within any required easement.
3. The maximum length of a continuous, unbroken and uninterrupted wall or fence plane is 50 feet. Breaks must be provided through the use of columns, landscaped areas, transparent sections or a change in material.

C. Height

1. Wall or fence height is measured from the subject property grade to the highest point of the wall or fence.
2. A wall or fence abutting a common lot line may be no more than 8 feet in height.
3. A wall or fence located in front yard or side street yard may be no more than 4 feet in height.

Div. 7.3. Site Lighting

Sec. 7.3.1. Applicability

A. New Fixtures

All lighting fixtures installed outside of the public right-of-way after the effective date of this Code must conform to all applicable standards of this Division.

B. Existing Fixtures

1. Routine maintenance, including changing the lamp, ballast, starter, photo control, fixture housing, lens and other required components, is allowed for all existing fixtures.
2. The installation of site lighting, replacement of site lighting and changes to existing light fixture wattage, type of fixture, mounting or fixture location must be made in compliance with this Division.

Sec. 7.3.2. Lighting Standards

A. Light Level Measuring

1. Light levels are specified, calculated and measured in footcandles. All footcandles values are maintained footcandles.
2. Measurements are to be made at ground level, with the light-registering portion of the meter held parallel to the ground pointing up.

B. Prohibited Sources

The following light fixtures and sources cannot be used:

1. Cobra-head-type fixtures having dished or drop lenses or refractors, which contain sources that are not incandescent; and
2. Temporary searchlights and other high-intensity narrow-beam, moving uplight fixtures.

C. Design and Installation

1. The maximum light level of any light fixture measured at the right-of-way line of a street cannot exceed an average of 2.5 footcandles. The uniformity ratio should be no more than 4:1.
2. Light sources must have a Color Rendering Index (CRI) value of 80 or higher.
3. Lighting must not be oriented onto adjacent properties, streets or sidewalks.
4. Service connections for all freestanding lighting fixtures must be installed underground.

D. Parking and Pedestrian Areas

1. Light fixtures within vehicle parking areas may be no higher than 30 feet.
2. Light fixtures within pedestrian areas mounted on poles may be no higher than 15 feet.

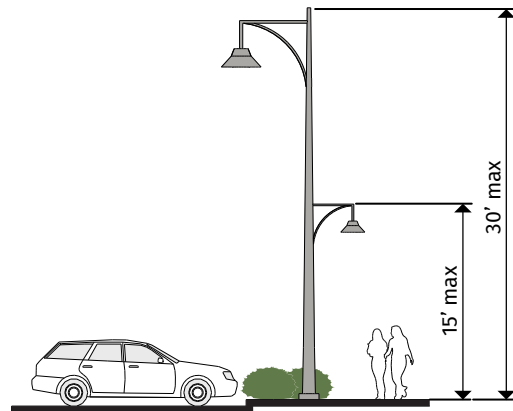

3. All light fixtures must be full cutoff, except as listed in paragraph 5. below.

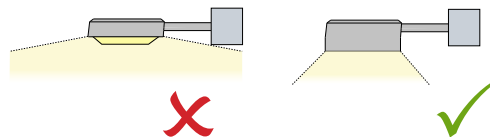

4. Non-cutoff (unshielded) fixtures can be used when the maximum initial lumens generated by each fixture is less than 9,500 initial lamp lumens. These fixtures generally feature globes or vertical glass planes and must be coated with an internal white frosting to diffuse light.

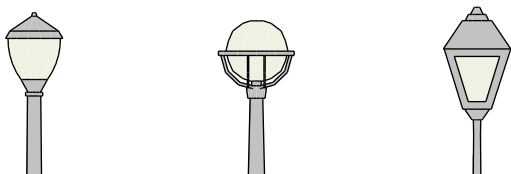

E. Flood Lights and Flood Lamps

1. Flood light fixtures must either be aimed down at least 45 degrees from vertical or the front of the fixture shielded so that no portion of the light bulb extends below the bottom edge of the shield.

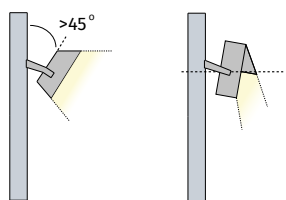

2. Any flood light fixture located within 50 feet of a street right-of-way must be mounted and aimed perpendicular to the right-of-way, with a side-to-side horizontal aiming tolerance not to exceed 15 degrees, except for small building mounted accents used for lighting signs and building features

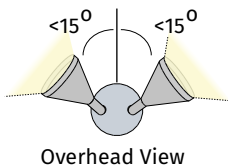

3. All adjustable flood lamps emitting 1,000 or more lumens must be aimed at least 60 degrees down from horizontal or shielded so that the main beam is not visible from adjacent properties or the right-of-way, except for flagpole lighting.

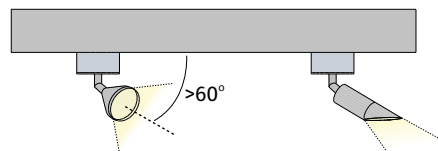

F. Vehicular Canopies

Lighting under vehicular canopies must be less than 24 maintained footcandles and be designed to prevent glare off-site. Acceptable lighting designs include the following:

1. Recessed

Recessed fixture incorporating a lens cover that is either recessed or flush with the bottom surface of the canopy;

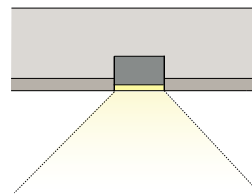

2. Shielded

Light fixture incorporating shields or is shielded by the edge of the canopy itself, so that light is restrained to 5 degrees or more below the horizontal plane;

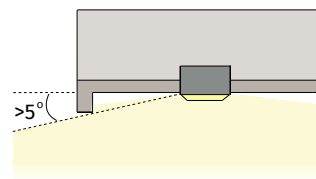

3. Surface Mounted

Surface mounted fixture incorporating a flat glass that provides a cutoff design or shielded light distribution; or

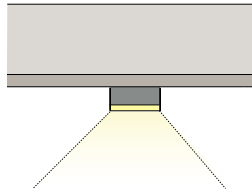

3. Only lighting used to accent architectural features, landscaping or art may be directed upward, provided that the fixture is located, aimed or shielded to minimize light spill into the night sky.

4. Indirect

Indirect lighting where light is beamed upward and then reflected down from the underside of the canopy, provided the fixture is shielded so that direct illumination is focused exclusively on the underside of the canopy.

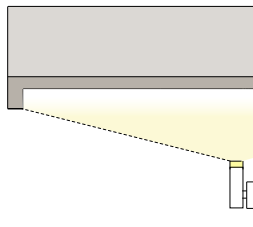

G. Building Lighting

1. Lighting fixtures must be selected, located, aimed and shielded so that direct illumination is focused exclusively on the building facade, plantings and other intended site features and away from adjoining properties and the street right-of-way.
2. All wall pack fixtures must be full cutoff fixtures.



Div. 7.4. Signs

Sec. 7.4.1. Applicability

The sign requirements of Chapter 6, Article 4 of the City of Fort Worth Zoning Ordinance apply, except as listed below:

- A. § 6.403.(f), Window Signs.
- B. § 6.408, Regulations Governing On-Premise Attached Signs in Commercial and Industrial Districts.
- C. § 6.409, Regulations Governing On-Premise Detached Signs in Commercial and Industrial Districts.

Sec. 7.4.2. Sign Types Allowed By District

Signs are allowed by district as set below. Specific requirements for each sign type are shown on the following pages.

| | Historic | | Transition | | | | | Edge | |
|---------------------|----------|-----|------------|-----|-----|-----|-----|------|-----|
| | HSH | HCO | TMC | TNF | TNX | TSA | TNE | ENX | ECC |
| A-Frame Sign | P | P | P | P | P | P | P | P | P |
| Awning Sign | P | P | P | P | P | P | P | P | P |
| Canopy Sign | P | P | P | P | P | P | P | P | P |
| Crown Sign | -- | -- | P | P | -- | P | P | -- | P |
| Monument Sign | -- | -- | -- | -- | -- | -- | -- | -- | P |
| Projecting Sign | P | P | P | P | P | P | P | P | P |
| Ranch Entrance Sign | -- | -- | P | P | -- | P | P | -- | -- |
| Shingle Sign | P | P | P | P | P | P | P | P | P |
| Wall Sign | P | P | P | P | P | P | P | P | P |
| Window Sign | P | P | P | P | P | P | P | P | P |

KEY: P = Sign allowed -- = Sign not allowed

Sec. 7.4.3. Sign Placement

- A. For the purpose of this Division, a Frontage means a designated Frontage included on the map in Div. 1.4, District and Frontage Map.
- B. Signs may be placed on any building facade that faces a Frontage, subject to the allocation and sign type regulations below.
- C. Signs may also be placed on any building facade that does not face a Frontage, subject to the allocation and sign type regulations below.

Sec. 7.4.4. Sign Allocation

A. Allocation Not Transferable

Sign allocation must be used on the building facade used to measure the allocation, and may not be transferred to a different building facade.

B. A-Frame Signs

The allocation for an A-frame Sign is in Sec. 7.4.5.

C. Awning, Canopy, Projecting and Wall Signs

- 1. Awning signs, canopy signs, projecting signs and wall signs are allocated a combined sign area of 36 square feet or 1.5 square feet per linear foot of building facade facing a Frontage included on the map in Div. 1.4, District and Frontage Map, whichever is greater.
- 2. Awning signs, canopy signs, projecting signs and wall signs are allocated a combined sign area of 0.5 square feet per linear foot of building facade not facing a Frontage included on the map in Div. 1.4, District and Frontage Map.

D. Crown Signs

The allocation for a Crown Sign is found in Sec. 7.4.8.

E. Monument Signs

- 1. The allocation for a Monument Sign is found in Sec. 7.4.9.
- 2. Properties with more than 1,000 linear feet of frontage included on the map in Div. 1.4, District and Frontage Map are allowed one additional monument sign on that Frontage.
- 3. Monument signs located on the same property must be spaced a minimum of 500 feet apart.

F. Ranch Entrance Signs

The allocation for a Ranch Entrance Sign is in Sec. 7.4.11.

G. Shingle Signs

The allocation for a Shingle Sign is in Sec. 7.4.12.

H. Window Signs

The allocation for Window Signs is in Sec. 7.4.14.

SEC. 7.4.5. A-FRAME SIGN

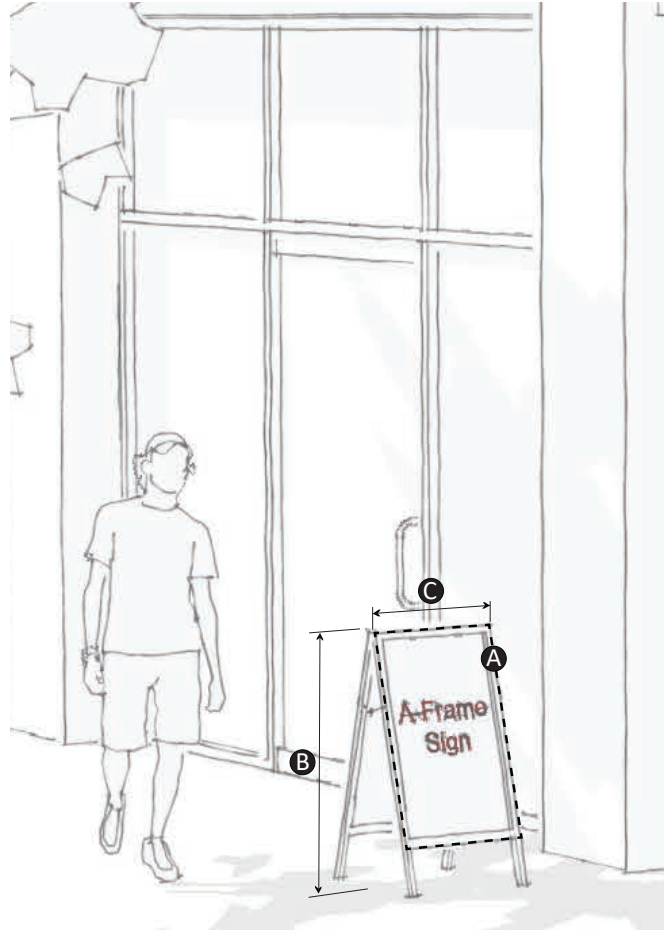

Description

A movable sign not secured or attached to the ground or surface upon which it is located.

General Provisions

1. An A-frame sign must be placed along a building facade with a customer entrance to a ground-floor tenant space
2. An A-frame sign must be placed no more than 12 feet from the building facade.
3. An A-frame sign must be located at least 25 feet from any other A-frame sign.
4. An A-frame sign must be removed and placed indoors when the tenant space is not open.
5. An A-frame signs must not obstruct vehicular, bicycle or pedestrian traffic and must comply with ADA clearance and accessibility.
6. An A-frame sign must not be illuminated.

Total Sign Area Allocation

One A-frame sign is allowed per ground floor tenant space.

Dimensions

| | | |
|----------|-------------------------------|------|
| A | Area of individual sign (max) | 6 SF |
| B | Height (max) | 3' |
| C | Width (max) | 2' |

SEC. 7.4.6. AWNING SIGN



Description

A sign where graphics or symbols are painted, sewn, or otherwise adhered to the material of an awning as an integrated part of the awning itself.

General Provisions

1. Only awnings over ground-story doors or windows may contain awning signs.
2. An awning sign may be placed on the face or the valance of the awning, but must not extend outside the awning.
3. An awning sign must not be illuminated.

Total Sign Area Allocation

See [Sec. 7.4.4.](#)

Dimensions

| | |
|---|-------|
| A Area of awning sign (max per awning) | 12 SF |
|---|-------|

SEC. 7.4.7. CANOPY SIGN

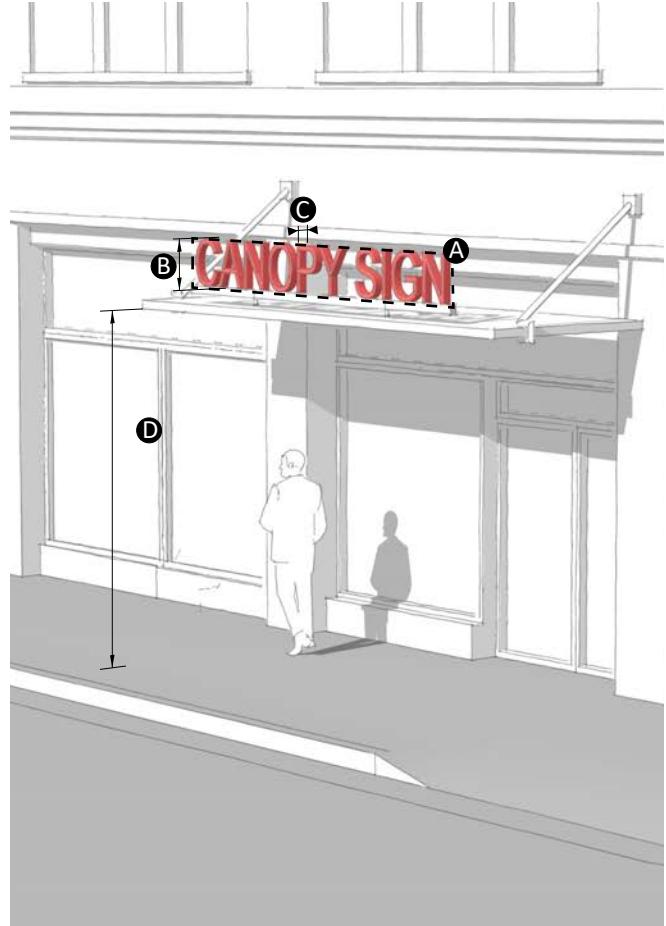

Description

A sign attached to a canopy with a display surface parallel to the plane of the building facade.

General Provisions

1. A canopy sign may extend above or below the canopy; however, it must not extend outside the overall length or width of the canopy.
2. Only a canopy over ground-story doors or windows may contain a canopy sign.
3. A maximum of one sign is allowed per canopy.
4. A canopy sign may be externally and internally illuminated in accordance with [Sec. 7.4.15](#).

Total Sign Area Allocation

See [Sec. 7.4.4](#).

Dimensions

| | | |
|----------|---|-------|
| A | Area of individual sign (max) | 64 SF |
| B | Height (max) | 6' |
| C | Depth (max) | 8" |
| D | Clear height above sidewalk (min) | 9' |
| D | Clear height above parking area or driveway (min) | 14' |

SEC. 7.4.8. CROWN SIGN

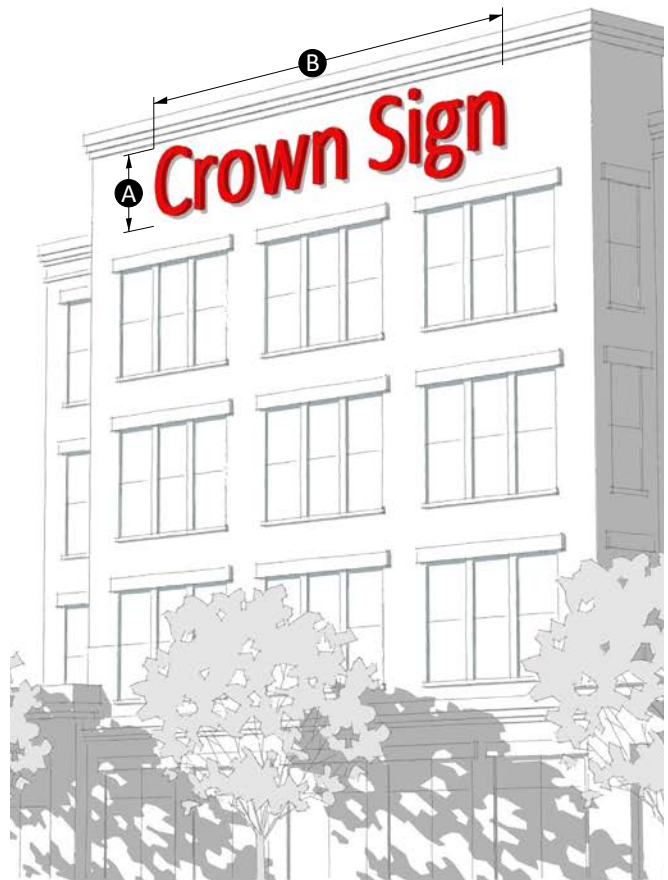

Description

A sign attached to the wall of a building or structure at least 4 stories in height, the display surface of which does not project more than 2 feet from the outside wall of the building or structure.

General Provisions

1. A crown sign is only allowed on building facades at least 4 stories in height.
2. A crown sign must not be placed below the start of the 4th story.
3. A crown sign must not extend above the roof line.
4. A crown sign must not cover windows or architectural details.
5. No more than 2 crown signs are allowed per building and no more than 1 crown sign per building facade is allowed.
6. A crown sign may be externally or internally illuminated in accordance with [Sec. 7.4.15](#).

Total Sign Area Allocation

Each allowed sign can be no more than 80 SF in area.

Dimensions

| | |
|--|-----|
| A Height (max) | 8' |
| Projection - measured from building facade (max) | 2' |
| B Width (max % of facade width) | 75% |

SEC. 7.4.9. MONUMENT SIGN

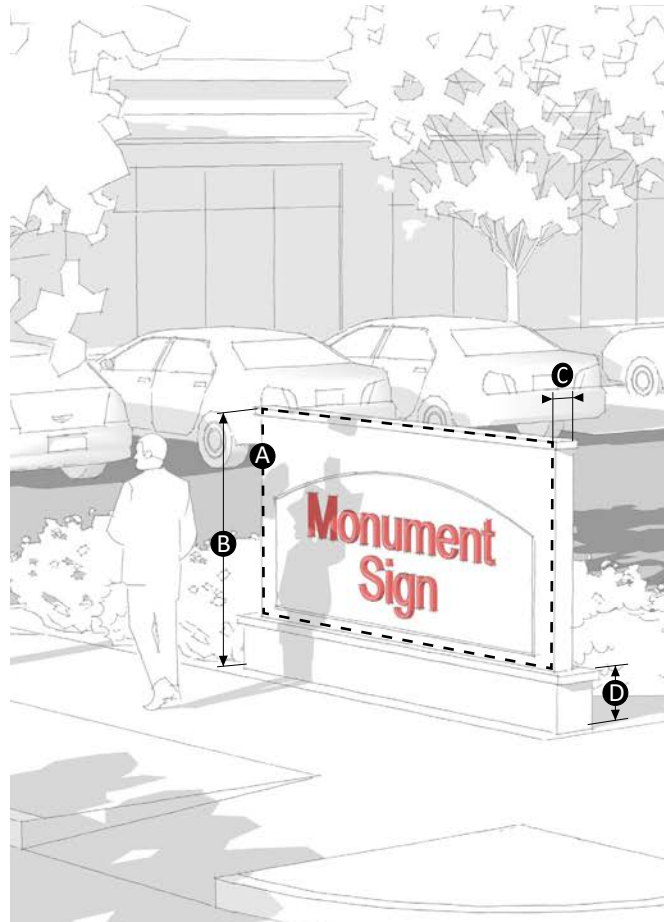

Description

A permanently affixed sign which is wholly independent of a building for support and attached to the ground along its entire length.

General Provisions

1. A monument sign must be set back at least 5 feet from a front lot line and 10 feet from a common lot line.
2. A monument sign may be externally or internally illuminated in accordance with [Sec. 7.4.15](#).

Total Sign Area Allocation

One sign no more than 64 SF in area.

Dimensions

| | | |
|----------|-------------------------------|-------|
| A | Area of individual sign (max) | 64 SF |
| B | Height, including base (max) | 6' |
| C | Depth (max) | 2' |
| D | Sign base height (min/max) | 1'/4' |

SEC. 7.4.10. PROJECTING SIGN

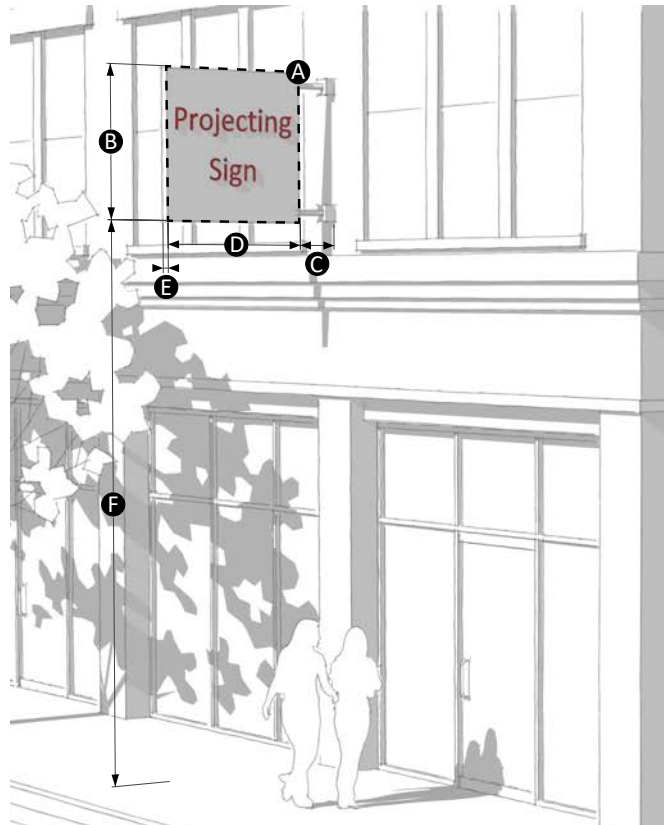

Description

A sign attached to the building facade at a 90-degree angle, extending more than 1 foot from the outside wall of the building or structure.

General Provisions

1. A projecting sign must be at least 25 feet from any other projecting sign.
2. A projecting sign may be erected on a building corner. Allocation of sign area from both streets may be used.
3. A projecting sign must be placed no higher than 24 feet above the sidewalk, measured from the top of the sidewalk to the highest point of the sign.
4. The top of a projecting sign must be no higher than the top of the building, except that on a one-story building, the top of a projecting sign may extend a maximum of 2 feet above the top of the building.
5. A projecting sign may be externally or internally illuminated in accordance with [Sec. 7.4.15](#).

Total Sign Area Allocation

See [Sec. 7.4.4](#).

Dimensions

| | | |
|----------|---|--------|
| A | Area of individual sign (max) | 36 SF |
| B | Height (max) | 6' |
| C | Spacing from building facade (min/max) | 1 1/2' |
| D | Projection width (max) | 6' |
| E | Sign depth (max) | 1' |
| F | Clear height above sidewalk (min) | 9' |
| F | Clear height above parking area or driveway (min) | 14' |

SEC. 7.4.11. RANCH ENTRANCE SIGN



Description

A sign located on private property over an entrance driveway or other private access.

General Provisions

1. Only one ranch entrance sign per property is allowed.
2. A ranch entrance sign must be located at least 10 feet from any side lot line.
3. The sign structure must be constructed of timber and metal.
4. A ranch entrance sign may only be externally illuminated in accordance with [Sec. 7.4.15](#).

Total Sign Area Allocation

One sign no more than 48 SF in area.

Dimensions

| | | |
|----------|---------------------------------------|-------|
| A | Area of individual sign (max) | 48 SF |
| B | Clear height above driveway (min/max) | 20' |

SEC. 7.4.12. SHINGLE SIGN

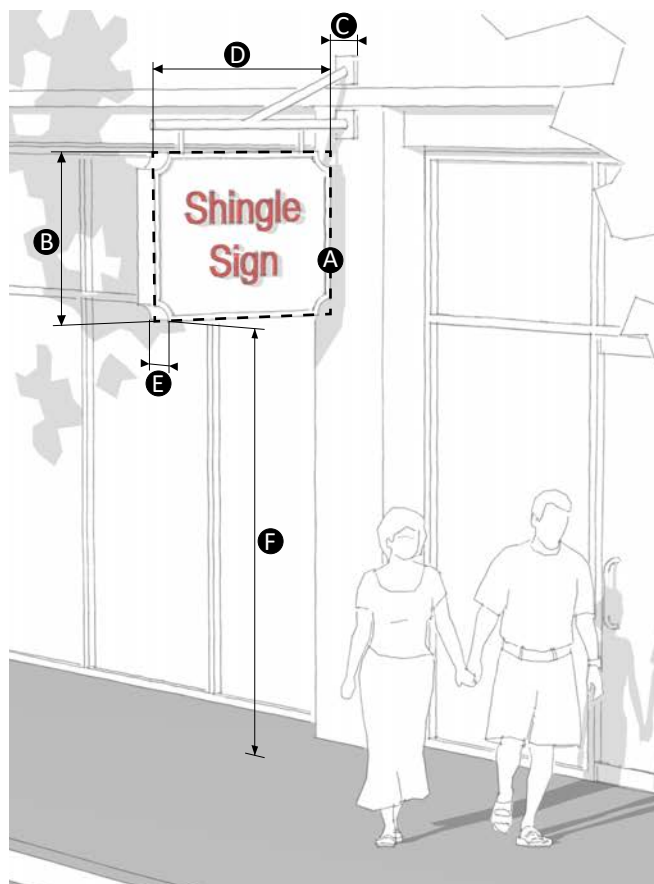

Description

A sign attached to the building facade at a 90-degree angle that hangs from a bracket or support extending more than 1 foot from the outside wall of the building or structure.

General Provisions

1. The hanging bracket must be an integral part of the sign design.
2. A shingle sign must be located below the window sills of the 2nd story on a multi-story building or below the roof line on a single-story building.
3. A shingle sign must be located within 5 feet of a ground story tenant entrance.
4. A shingle sign must be located at least 25 feet from any other shingle sign.
5. A shingle sign must not be illuminated.

Total Sign Area Allocation

One shingle sign is allowed per ground story tenant space.

Dimensions

| | | |
|----------|---|-------|
| A | Area of individual sign (max) | 9 SF |
| B | Height (max) | 3' |
| C | Spacing from building facade (min/max) | 6"/1' |
| D | Projection width (max) | 3' |
| E | Sign depth (max) | 6" |
| F | Clear height above sidewalk (min) | 9' |
| F | Clear height above parking area or driveway (min) | 14' |

SEC. 7.4.13. WALL SIGN



Description

A sign attached to the wall or surface of a building or structure, the display surface of which does not project more than 1 foot from the outside wall of the building or structure.

General Provisions

1. A wall sign must be placed no higher than 24 feet above the sidewalk, measured from the top of the sidewalk to the highest point of the sign.
2. A wall sign must not extend above the roof line or above a parapet wall of a building with a flat roof.
3. A wall sign must not cover windows or architectural details.
4. A wall sign may be externally or internally illuminated in accordance with [Sec. 7.4.15](#).

Total Sign Area Allocation

See [Sec. 7.4.4](#).

Dimensions

| | | |
|---|--|--------------------------------|
| A | Area of individual sign (max) | No max except total allocation |
| B | Projection - measured from building facade (max) | |

SEC. 7.4.14. WINDOW SIGN

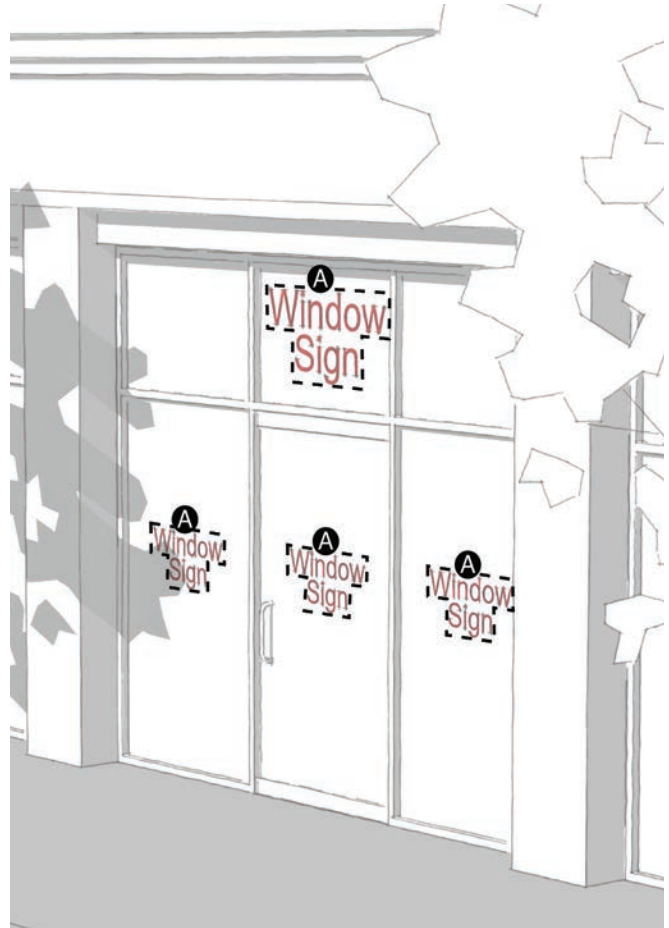

Description

A sign affixed to the inside of a window or door, or a sign placed within a building less than 10 feet from a window or door so as to be plainly visible and legible through a window or door.

General Provisions

1. Window signs are only allowed on transparent ground story windows and doors.
2. Window signs are not transferable, and must be placed on the window or door used to measure the allocation.
3. A window sign must not be illuminated.

Total Sign Area Allocation

20% of each transparent ground story window and door

Dimensions

| | | |
|---|--|-----|
| A | Maximum area of each transparent ground story window or door | 20% |
|---|--|-----|



External light sources

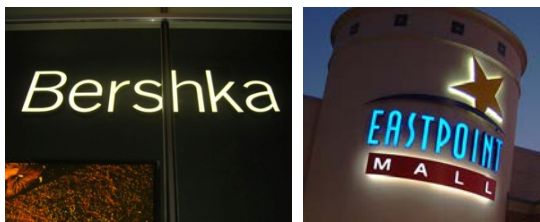

Internally lit channel letters



Back lit channel letters



Internally lit signs with darker backgrounds

Sec. 7.4.15. Illumination

Illumination of signs must be in accordance with the following requirements.

1. Illumination Permitted by Sign Type

| | Internal | External |
|-----------------|----------|----------|
| A-Frame Sign | No | No |
| Awning Sign | No | No |
| Canopy Sign | Yes | Yes |
| Crown Sign | Yes | Yes |
| Monument Sign | Yes | Yes |
| Projecting Sign | Yes | Yes |
| Ranch Sign | No | Yes |
| Shingle Sign | No | No |
| Wall Sign | Yes | Yes |
| Window Sign | No | No |

2. Prohibited Light Sources

- a. Blinking, flashing and chasing.
- b. Colored lights used in any manner so as to be confused with or construed as traffic control devices.
- c. Direct reflected light that creates a hazard to operators of motor vehicles.
- d. Lights that outline property lines, sales areas, roof lines, doors, windows or similar areas are prohibited, except for seasonal lighting or very low luminosity lighting displays using multiple lamps.

3. Internal Illumination

- a. For internally illuminated signs on a background, the background must be opaque or a darker color than the message of the sign.
- b. Internally illuminated signs using channel letters may be internally lit or back-lit.

4. External Illumination

- a. Bare bulb illumination (including neon) is allowed.
- b. Lighting directed toward a sign must be shielded so that it illuminates only the face of the sign and does not shine directly onto public right-of-way or adjacent properties.
- c. Projecting light fixtures used for externally illuminated signs must be simple and unobtrusive in appearance and not obscure the sign.

Div. 7.5. Outdoor Display and Storage

Sec. 7.5.1. Applicability

The requirements of this Division apply where merchandise, material or equipment is stored outside of a completely enclosed building.

Sec. 7.5.2. Outdoor Display

A. Defined

1. The outdoor display of products actively available for sale.
2. The outdoor placement of ice storage bins, soft drink, video rentals or similar vending machines is considered outdoor display and must meet the standards below except for Sec. 7.5.2.B.2.

B. Standards

1. Outdoor display is only allowed with an allowed nonresidential use with ground floor frontage.
2. Outdoor display must be removed and placed inside a fully-enclosed building at the end of each business day.
3. Outdoor display may not encroach upon any right-of-way or sidewalk. Outdoor display may not impair the ability of pedestrians to use the sidewalk. There must be a minimum of 6 feet of clear distance of sidewalk at all times.
4. Outdoor display must abut the primary facade with the principal customer entrance, and may not extend more than 6 feet from the facade or occupy more than 25% of the horizontal length of the facade.
5. Outdoor display cannot exceed 6 feet in height.

Sec. 7.5.3. Limited Outdoor Storage

A. Defined

1. The outdoor storage of in crates, on pallets or in shipping containers;
2. Outdoor sale areas for sheds, building supplies and garden supplies;
3. The outdoor storage of contractors' equipment; and
4. The outdoor storage of vehicles, boats, recreational vehicles, trailers or other similar vehicles.

B. Standards

Limited outdoor storage may not be more than 12 feet in height and must be fully screened from view from the public right-of-way by landscaping or an opaque wall or fence that is compatible with the principal building in terms of texture, quality, material and color.

Sec. 7.5.4. General Outdoor Storage

A. Defined

1. The overnight outdoor storage of vehicles awaiting repair; and
2. The outdoor storage of soil, mulch, stone, lumber, pipe, steel, salvage or recycled materials, and other similar merchandise, material or equipment.

B. Standards

General outdoor storage is not permitted.

ARTICLE 8. STREET STANDARDS

| | |
|---|------|
| Div. 8.1. General Provisions | 8-2 |
| Sec. 8.1.1. Applicability | 8-2 |
| Sec. 8.1.2. Dimensional Standards | 8-2 |
| Div. 8.2. Future Streets and Pathways Map | 8-3 |
| Div. 8.3. Street and Pathway Types | 8-4 |
| Sec. 8.3.1. A Street: Stockyards Boulevard | 8-4 |
| Sec. 8.3.2. A Street: Swift & Armour Boulevard | 8-5 |
| Sec. 8.3.3. A Street: 23 Street | 8-6 |
| Sec. 8.3.4. A Street: Main Street (South) | 8-7 |
| Sec. 8.3.5. A Street: Main Street (Core) | 8-8 |
| Sec. 8.3.6. A Street: Main Street (North) | 8-9 |
| Sec. 8.3.7. B Street: Existing | 8-10 |
| Sec. 8.3.8. B Street: Proposed | 8-11 |
| Sec. 8.3.9. B Street: Cycle-Track | 8-12 |
| Sec. 8.3.10. B street: Ellis Avenue | 8-13 |
| Sec. 8.3.11. B Street: West Exchange Avenue | 8-14 |
| Sec. 8.3.12. B Street: East Exchange Avenue | 8-15 |
| Sec. 8.3.13. B Street: Packers Avenue | 8-16 |
| Sec. 8.3.14. Pathway: Typical | 8-17 |
| Sec. 8.3.15. Pathway: with Cattle Run | 8-18 |
| Sec. 8.3.16. Pathway: Rodeo Plaza (North) | 8-19 |
| Sec. 8.3.17. Pathway: Rodeo Plaza (South) | 8-20 |
| Sec. 8.3.18. Pathway: Rodeo Alley | 8-21 |

Div. 8.1. General Provisions

Sec. 8.1.1. Applicability

- A. Streets and pathways must be constructed in accordance with the Future Street and Pathway Map in [Div. 8.2](#).
- B. The Director of Transportation and Public Works may modify a future street or pathway alignment as shown on the Future Streets and Pathways Map subject to the following:
 - 1. The requested modification does not increase congestion or compromise public safety;
 - 2. The requested modification does not decrease the number of connections to the overall street network;
 - 3. The requested modification does not create any lots without direct street frontage;
 - 4. The requested modification does not create a block perimeter that exceeds 1,600 feet; and
 - 5. The requested modification does not create a block length that exceeds 500 feet.
- C. Pathways designated on the Future Streets and Pathways Map can be used to meet the maximum block perimeter and length standards.
- D. A block may be bounded by a natural or man-made obstruction such as a creek or rail line.

Sec. 8.1.2. Dimensional Standards

- A. The required dimensional standards for the streets and pathways identified on the Future Streets and Pathways Map are shown in [Div. 8.3](#).
- B. All streets and pathways must be constructed with sidewalks, street trees, bike facilities, medians, travel lanes and on-street parking as shown for each street or pathway type, unless an alternative is approved by the Director of Transportation and Public Works.
- C. Modifications to the street and pathway dimensional standards may be allowed by the Transportation and Public Works Director where necessary to address specific conditions. The modifications must be the minimum necessary to address specific conditions, while preserving the integrity of the street and minimizing impacts on the pedestrian or cyclist experience.

Div. 8.2. Future Streets and Pathways Map

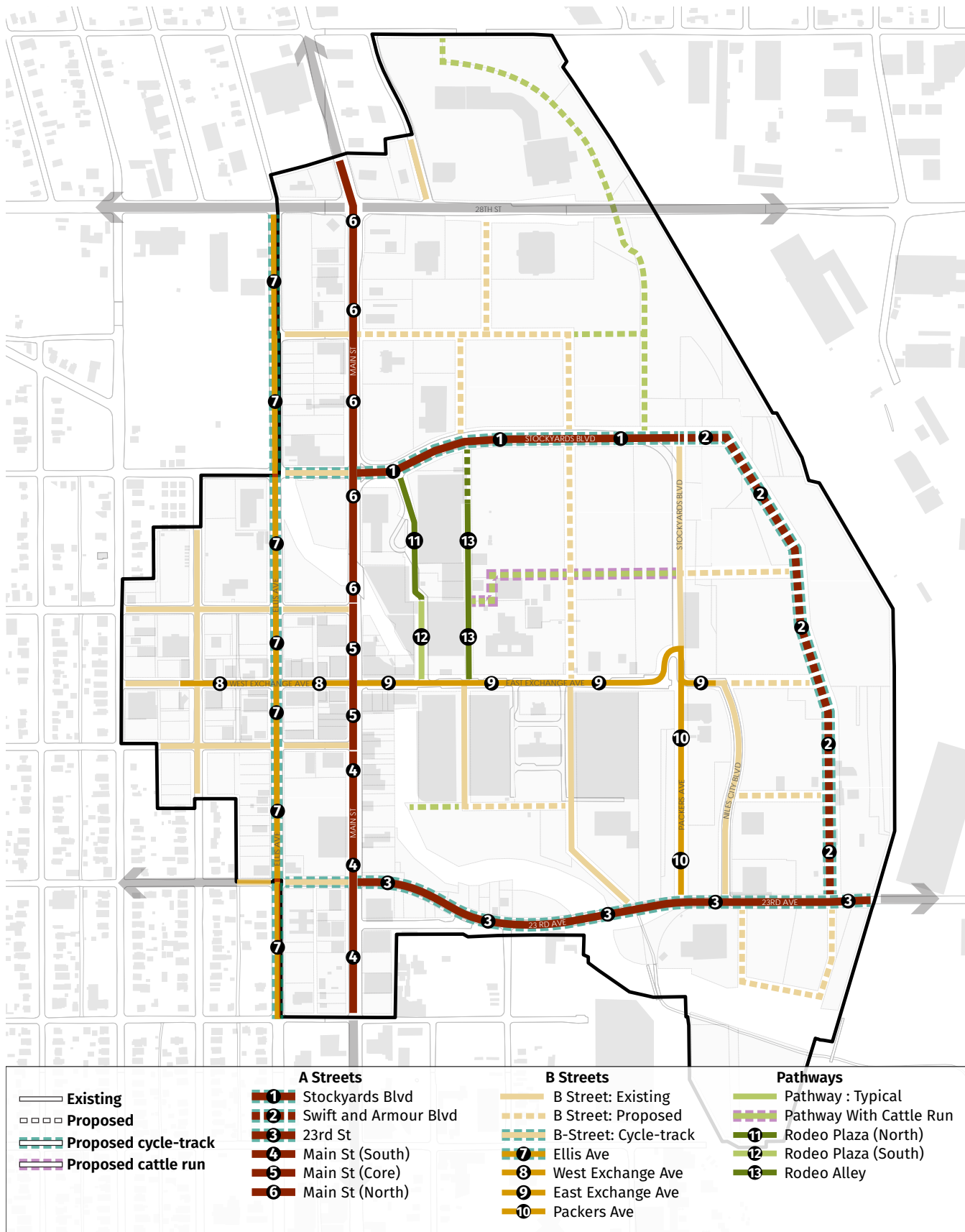

Div. 8.3. Street and Pathway Types

SEC. 8.3.1. A STREET: STOCKYARDS BOULEVARD

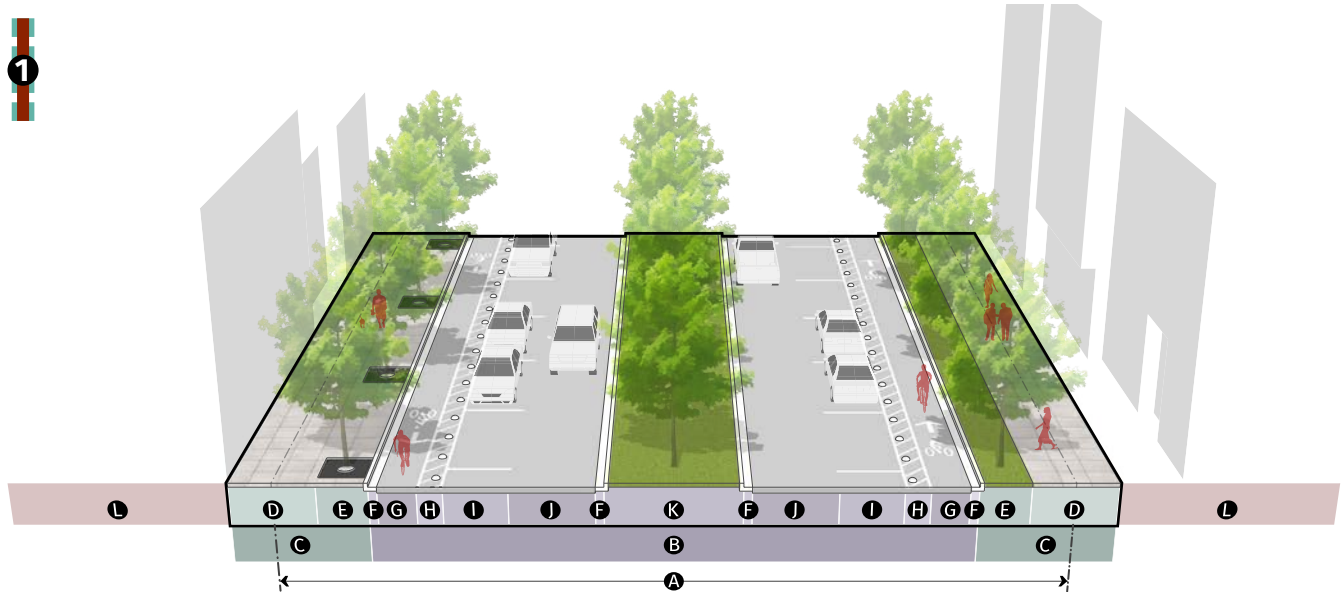

| Public Realm | |
|-----------------------|---------|
| A Right-of-way | 97' min |
| B Curb-to-curb | 65' min |
| C Streetscape | 16' min |

| Streetscape | |
|--------------------------------|--|
| D Paved pedestrian zone | 10' min |
| E Parkway depth | 6' min |
| Street tree planting type | Landscape/pavers/grates |
| Tree spacing | |
| Small canopy | 15' on-center avg. |
| Medium canopy | 25' on-center avg. |
| Large canopy | 35' on-center avg. |
| Roadway & pedestrian lighting | Required: installed per TPW specifications |

| Curb-to-Curb | |
|---|---------------------|
| F Gutter | 1' min |
| G Bicycle lane | 4'6" min |
| H Bicycle buffer | 3' min |
| I Parking lane | 7'6" min (parallel) |
| J Travel lane | 10' min / 11' max |
| K Median | 11' min / 16' max |
| Large canopy trees required in median spaced 35' on-center avg. | |

| Frontage | |
|--------------------------------------|--|
| L See applicable sub-district | |

SEC. 8.3.2. A STREET: SWIFT & ARMOUR BOULEVARD

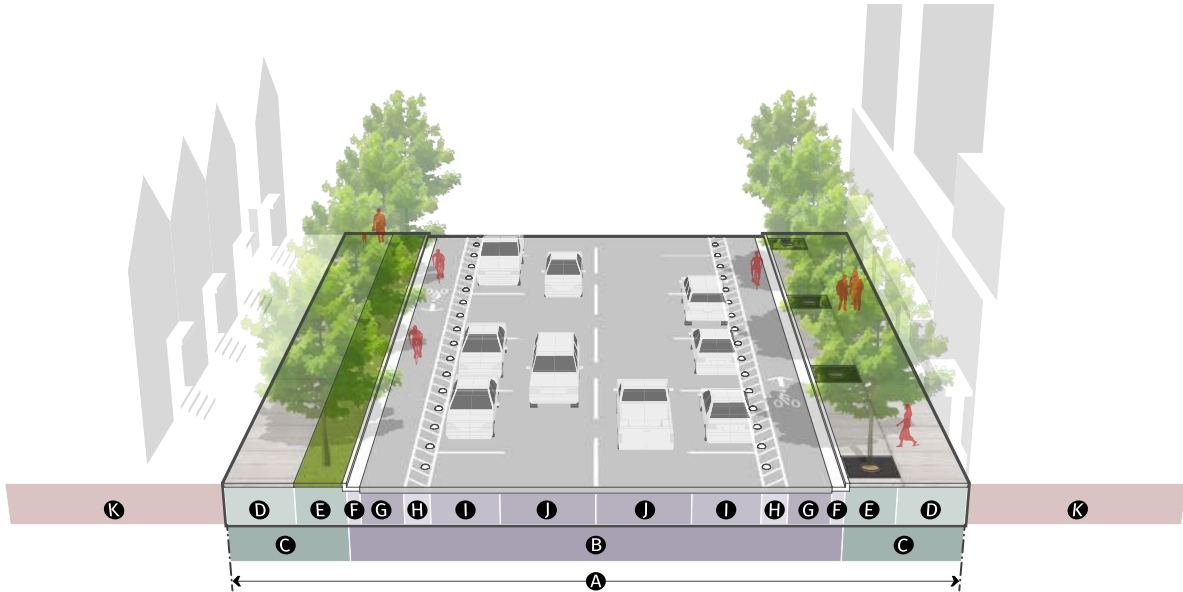

| Public Realm | |
|-----------------------|---------|
| A Right-of-way | 80' min |
| B Curb-to-curb | 54' min |
| C Streetscape | 13' min |

| Streetscape | |
|--------------------------------|--|
| D Paved pedestrian zone | 8' min |
| E Parkway depth | 5' min |
| Street tree planting type | Landscape/pavers/grates |
| Tree spacing | |
| Small canopy | 15' on-center avg. |
| Medium canopy | 25' on-center avg. |
| Large canopy | 35' on-center avg. |
| Roadway & pedestrian lighting | Required: installed per TPW specifications |

| Curb-to-Curb | |
|-------------------------|-------------------|
| F Gutter | 1' 6" min |
| G Bicycle lane | 4' 6" min |
| H Bicycle buffer | 3' min |
| I Parking lane | 8' min (parallel) |
| J Travel lane | 10' min / 11' max |

| Frontage | |
|--------------------------------------|--|
| K See applicable sub-district | |

SEC. 8.3.3. A STREET: 23 STREET

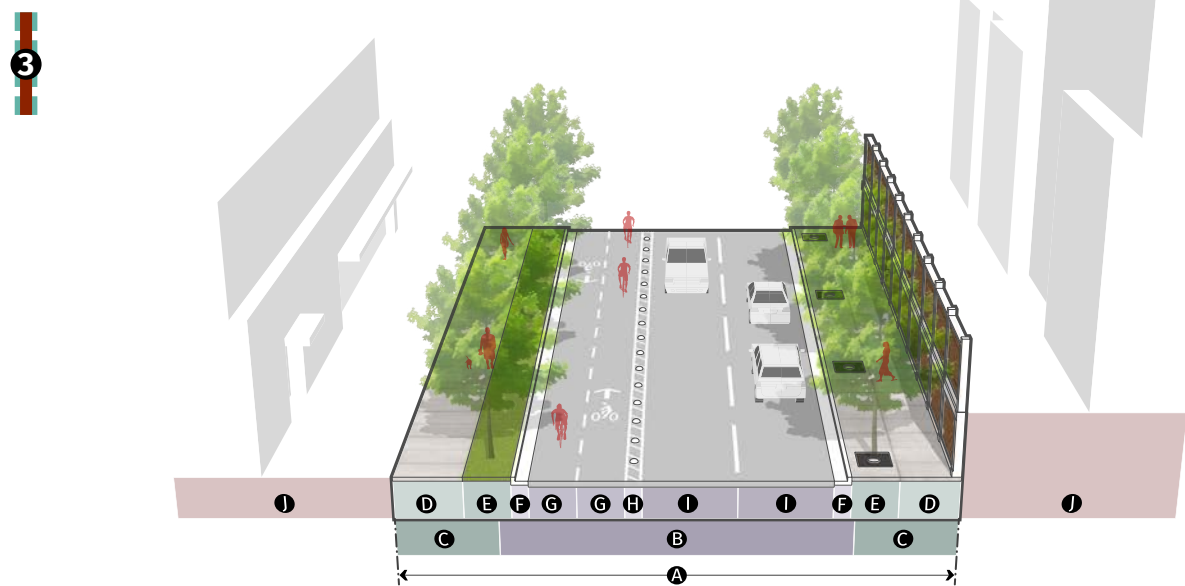

| Public Realm | |
|-----------------------|---------|
| A Right-of-way | 65' min |
| B Curb-to-curb | 37' min |
| C Streetscape | 14' min |

| Streetscape | |
|--------------------------------|--|
| D Paved pedestrian zone | 8' min |
| E Parkway depth | 6' min |
| Street tree planting type | Landscape/pavers/grates |
| Tree spacing | |
| Small canopy | 15' on-center avg. |
| Medium canopy | 25' on-center avg. |
| Large canopy | 35' on-center avg. |
| Roadway & pedestrian lighting | Required: installed per TPW specifications |

| Curb-to-Curb | |
|-------------------------|-------------------|
| F Gutter | 1'6" min |
| G Bicycle lane | 5' min |
| H Bicycle buffer | 2' min |
| I Travel lane | 10' min / 11' max |

| Frontage | |
|--------------------------------------|--|
| J See applicable sub-district | |

SEC. 8.3.4. A STREET: MAIN STREET (SOUTH)

4

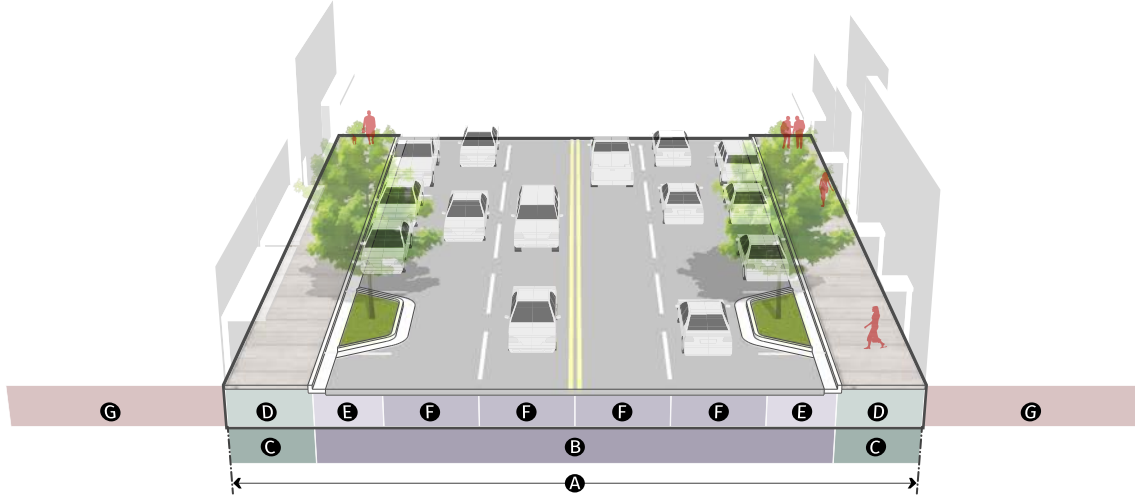

| Public Realm | |
|-----------------------|---------|
| A Right-of-way | 80' min |
| B Curb-to-curb | 60' min |
| C Streetscape | 10' min |

| Streetscape | |
|--------------------------------|--|
| D Paved pedestrian zone | 10' min |
| Roadway & pedestrian lighting | Required: installed per TPW specifications |

| Curb-to-Curb | |
|---|---------------------|
| E Parking lane (includes gutter) | 8' min (parallel) |
| Street tree planting | Bulb-out planter |
| Tree spacing | |
| Large canopy | 100' on-center avg. |
| F Travel lane | 10' min / 11' max |

| Frontage | |
|--------------------------------------|--|
| G See applicable sub-district | |

SEC. 8.3.5. A STREET: MAIN STREET (CORE)

5

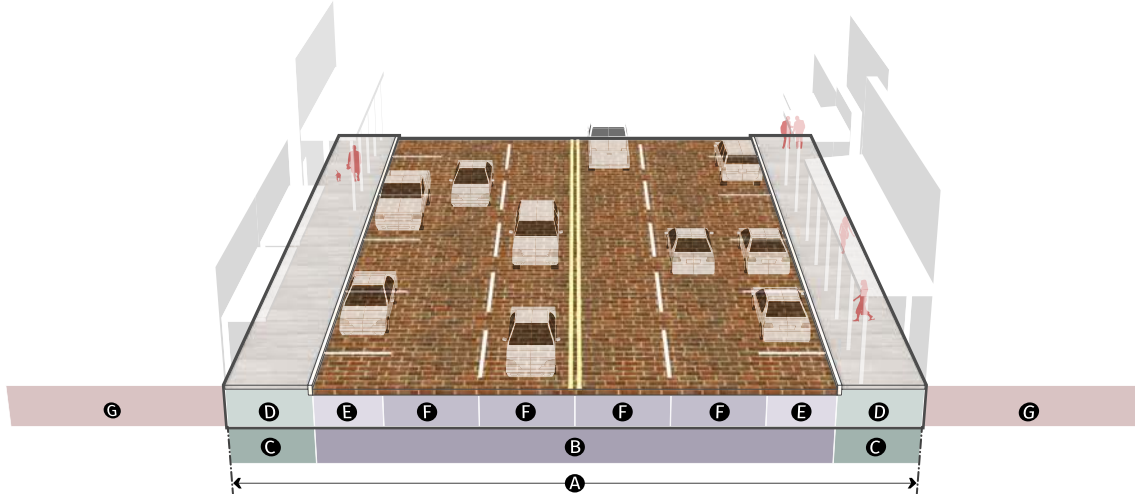

| Public Realm | |
|--------------|----------------------|
| A | Right-of-way 80' min |
| B | Curb-to-curb 60' min |
| C | Streetscape 10' min |

| Streetscape | |
|-------------|--|
| D | Paved pedestrian zone 10' min |
| | Street tree planting Not allowed |
| | Roadway & pedestrian lighting Required: installed per TPW specifications |

| Curb-to-Curb | |
|--------------|---|
| E | Parking lane, brick paver 8' min (parallel) |
| F | Travel lane, brick paver 10' min / 11' max |

| Frontage | |
|----------|-----------------------------|
| G | See applicable sub-district |

SEC. 8.3.6. A STREET: MAIN STREET (NORTH)

6

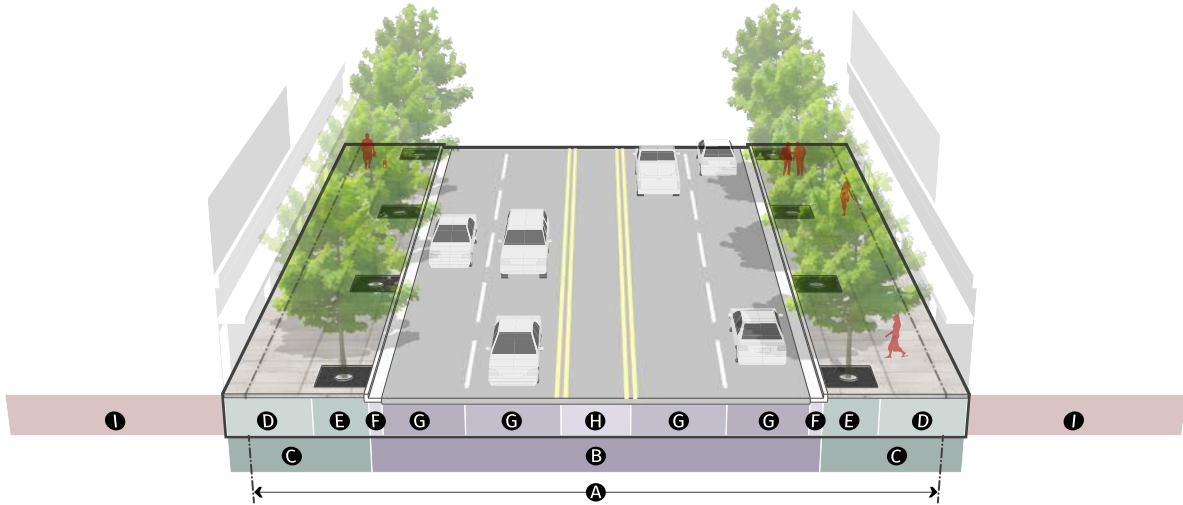

| Public Realm | | |
|--------------|--------------|---------|
| A | Right-of-way | Varies |
| B | Curb-to-curb | Varies |
| C | Streetscape | 16' min |

| Streetscape | | |
|-------------|-------------------------------|--|
| D | Paved pedestrian zone | 10' min |
| E | Parkway depth | 6' min |
| | Street tree planting type | Grates |
| | Tree spacing | |
| | Small canopy | 15' on-center avg. |
| | Medium canopy | 25' on-center avg. |
| | Large canopy | 35' on-center avg. |
| | Roadway & pedestrian lighting | Required: installed per TPW specifications |

| Curb-to-Curb | | |
|--------------|--------------------|-------------------|
| F | Gutter | 1'6" min |
| G | Travel lane | 10' min / 11' max |
| H | Median / turn lane | Varies |

| Frontage | | |
|----------|-----------------------------|--|
| I | See applicable sub-district | |

SEC. 8.3.7. B STREET: EXISTING

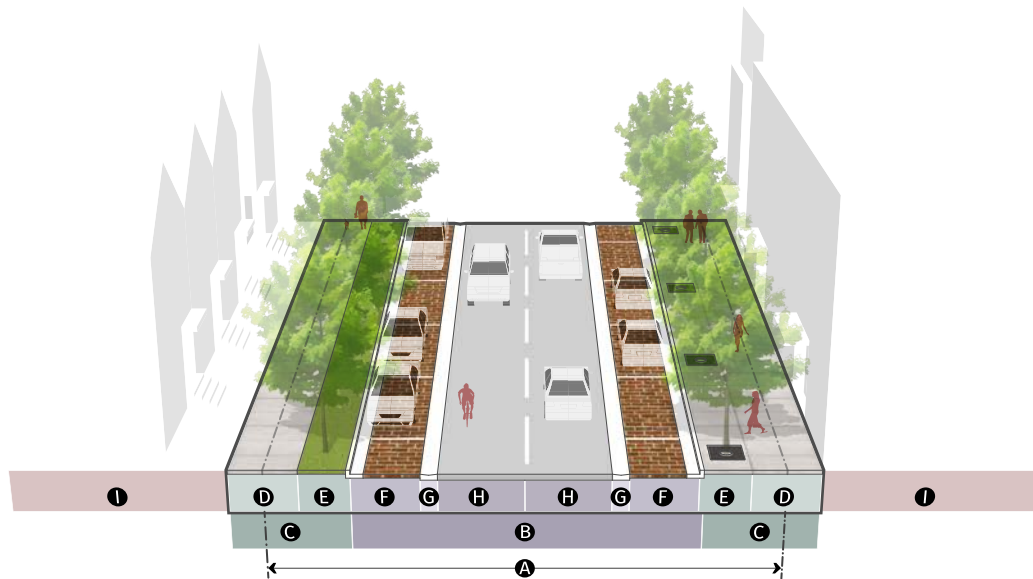

| Public Realm | |
|-----------------------|---------|
| A Right-of-way | 60' min |
| B Curb-to-curb | 40' min |
| C Streetscape | 14' min |

| Streetscape | |
|--------------------------------|--|
| D Paved pedestrian zone | 8' min |
| E Parkway depth | 6' min |
| Street tree planting type | Landscape/pavers/grates |
| Tree spacing | |
| Small canopy | 15' on-center avg. |
| Medium canopy | 25' on-center avg. |
| Large canopy | 35' on-center avg. |
| Roadway & pedestrian lighting | Required: installed per TPW specifications |

| Curb-to-Curb | |
|--|--------------------|
| F Parking lane, brick paver (includes gutter) | 8' min (parallel) |
| G Valley gutter | 2' min |
| H Travel lane | 10' min / 11' max |
| Bicycle facilities | Shared travel lane |

| Frontage | |
|--------------------------------------|--|
| I See applicable sub-district | |

SEC. 8.3.8. B STREET: PROPOSED

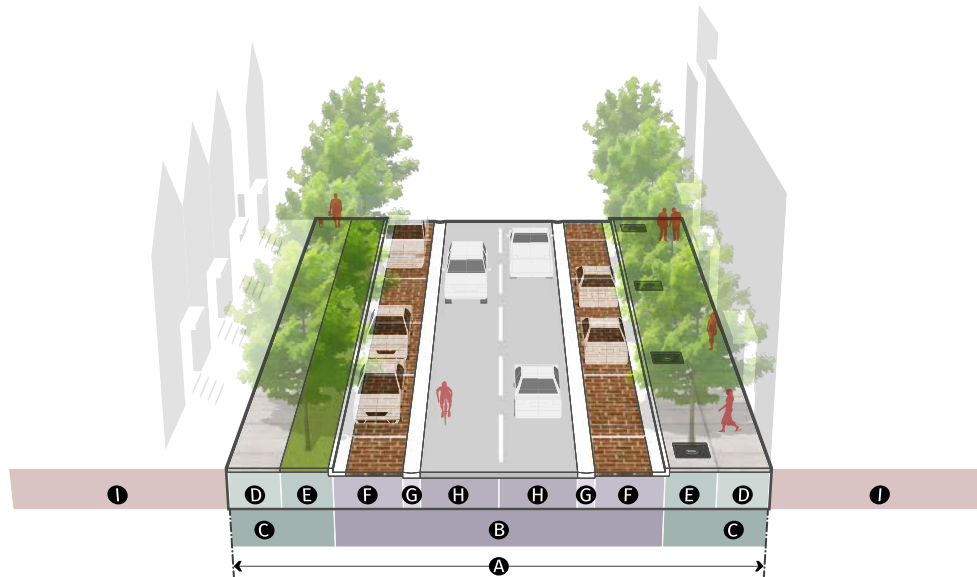

| Public Realm | |
|-----------------------|---------|
| A Right-of-way | 60' min |
| B Curb-to-curb | 38' min |
| C Streetscape | 11' min |

| Streetscape | |
|--------------------------------|--|
| D Paved pedestrian zone | 6' min |
| E Parkway depth | 5' min |
| Street tree planting type | Landscape/pavers/grates |
| Tree spacing | |
| Small canopy | 15' on-center avg. |
| Medium canopy | 25' on-center avg. |
| Large canopy | 35' on-center avg. |
| Roadway & pedestrian lighting | Required: installed per TPW specifications |

| Curb-to-Curb | |
|--|--------------------|
| F Parking lane, brick paver (includes gutter) | 7' min (parallel) |
| G Valley gutter | 2' min |
| H Travel lane | 10' min / 11' max |
| Bicycle facilities | Shared travel lane |

| Frontage | |
|--------------------------------------|--|
| I See applicable sub-district | |

SEC. 8.3.9. B STREET: CYCLE-TRACK

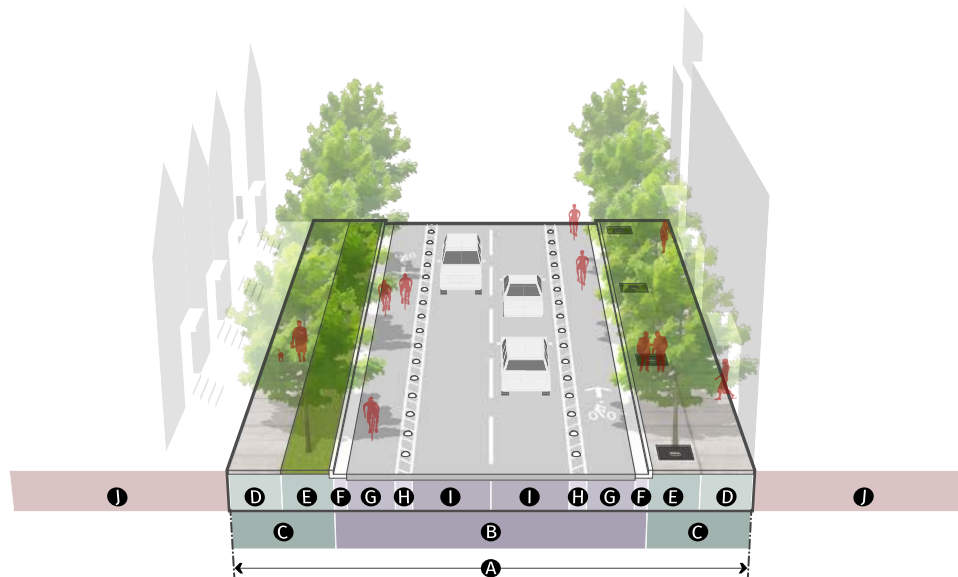

| Public Realm | |
|-----------------------|-----------|
| A Right-of-way | 60' min |
| B Curb-to-curb | 37' min |
| C Streetscape | 11'6" min |

| Streetscape | |
|--------------------------------|--|
| D Paved pedestrian zone | 6' min |
| E Parkway depth | 5'6" min |
| Street tree planting type | Landscape/pavers/grates |
| Tree spacing | |
| Small canopy | 15' on-center avg. |
| Medium canopy | 25' on-center avg. |
| Large canopy | 35' on-center avg. |
| Roadway & pedestrian lighting | Required: installed per TPW specifications |

| Curb-to-Curb | |
|-------------------------|-------------------|
| F Gutter | 1'6" min |
| G Bicycle lane | 5' min |
| H Bicycle buffer | 2' min |
| I Travel lane | 10' min / 11' max |

| Frontage | |
|--------------------------------------|--|
| J See applicable sub-district | |

SEC. 8.3.10. B STREET: ELLIS AVENUE

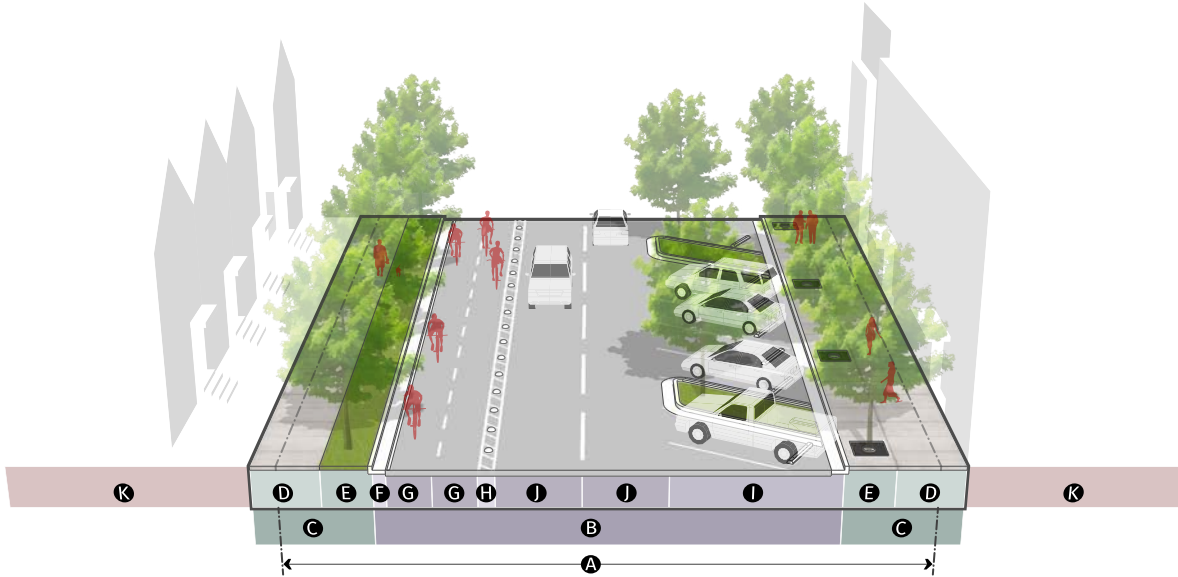

Public Realm

| | |
|-----------------------|-----------|
| A Right-of-way | 76' min |
| B Curb-to-curb | 53'6" min |
| C Streetscape | 13' min |

Streetscape

| | |
|--------------------------------|--|
| D Paved pedestrian zone | 8' min |
| E Parkway depth | 5' min |
| Street tree planting type | Landscape/pavers/grates |
| Tree spacing | |
| Small canopy | 15' on-center avg. |
| Medium canopy | 25' on-center avg. |
| Large canopy | 35' on-center avg. |
| Roadway & pedestrian lighting | Required: installed per TPW specifications |

Curb-to-Curb

| | |
|--|-------------------|
| F Gutter | 1'6" min |
| G Bicycle lane | 5' min |
| H Bicycle buffer | 2' min |
| I Parking lane (including gutter) | 20' min (angled) |
| J Travel lane | 10' min / 11' max |

Frontage

| | |
|--------------------------------------|--|
| K See applicable sub-district | |
|--------------------------------------|--|

SEC. 8.3.11. B STREET: WEST EXCHANGE AVENUE

8

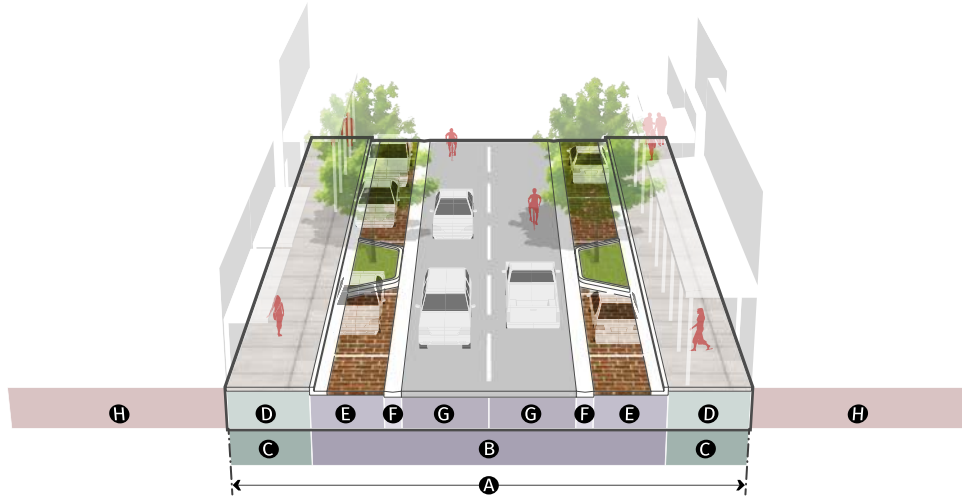

| Public Realm | |
|--------------|----------------------|
| A | Right-of-way 60' min |
| B | Curb-to-curb 40' min |
| C | Streetscape 10' min |

| Streetscape | |
|-------------|--|
| D | Paved pedestrian zone 10' min |
| | Roadway & pedestrian lighting Required: installed per TPW specifications |

| Curb-to-Curb | |
|--------------|---|
| E | Parking lane, brick paver (includes gutter) 8' min (parallel) |
| | Street tree planting type Bulb-out planter |
| | Tree spacing: large canopy 100' on-center avg. |
| F | Valley gutter 2' min |
| G | Travel lane 10' min / 11' max |

| Frontage | |
|----------|-----------------------------|
| H | See applicable sub-district |

SEC. 8.3.12. B STREET: EAST EXCHANGE AVENUE

9

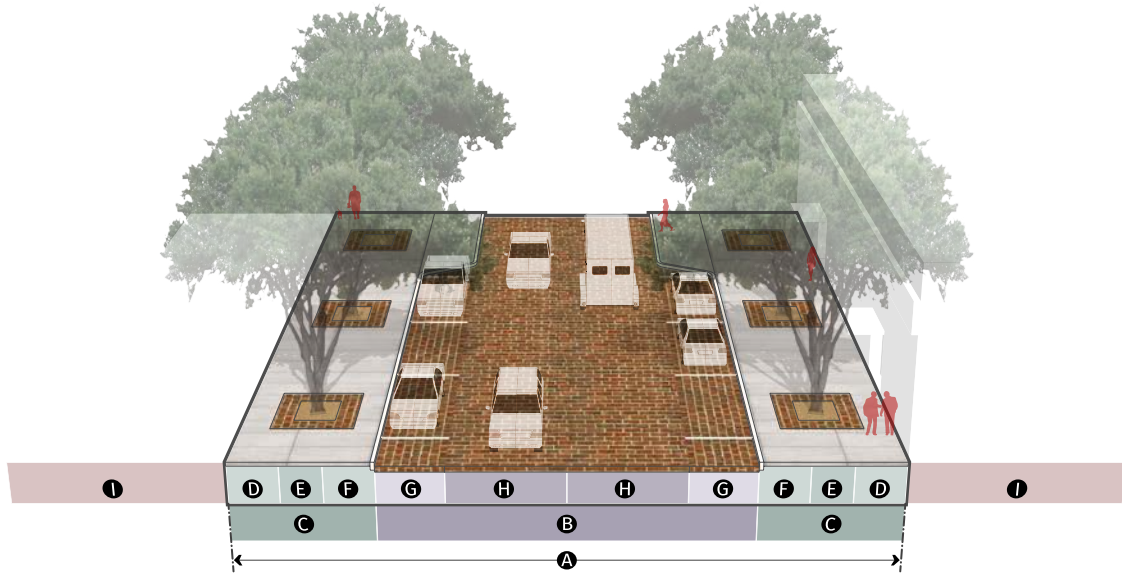

| Public Realm | |
|--------------|----------------------|
| A | Right-of-way 78' min |
| B | Curb-to-curb 44' min |
| C | Streetscape 17' min |

| Streetscape | |
|--|------------------------------|
| D | Paved pedestrian zone 6' min |
| E | Parkway depth 5' min |
| Street tree planting type Tree well | |
| Tree spacing: large canopy 35' on-center avg. | |
| F | Paved pedestrian zone 6' min |
| Roadway & pedestrian lighting Required: installed per TPW specifications | |

| Curb-to-Curb | |
|---------------------------------------|---|
| G | Parking lane, brick paver 8' min (parallel) |
| H | Travel lane, brick paver 12' min / 14' max |
| Bicycle facilities Shared travel lane | |

| Frontage | |
|----------|-----------------------------|
| I | See applicable sub-district |

SEC. 8.3.13. B STREET: PACKERS AVENUE

10

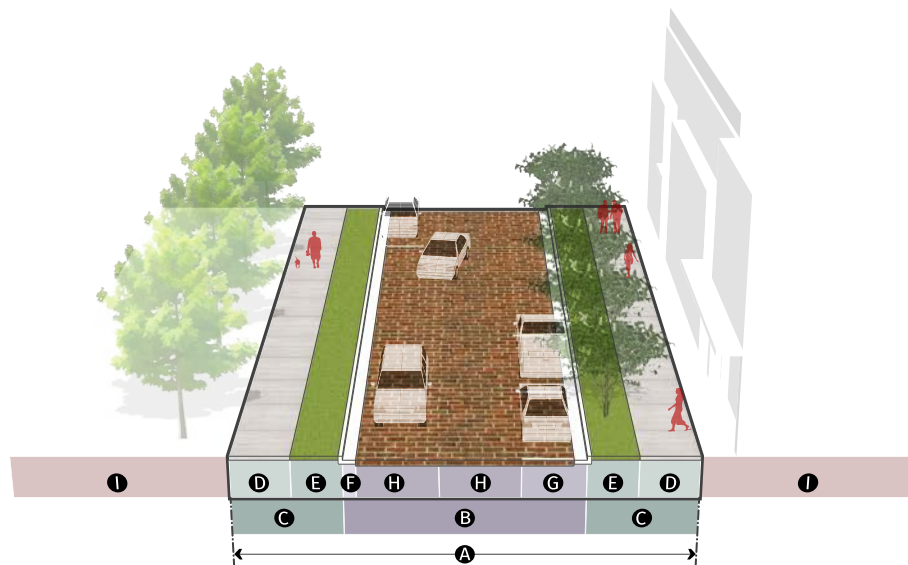

| Public Realm | |
|-----------------------|---------|
| A Right-of-way | 54' min |
| B Curb-to-curb | 28' min |
| C Streetscape | 13' min |

| Streetscape | |
|--------------------------------|--|
| D Paved pedestrian zone | 7' min |
| E Parkway depth | 6' min |
| Street tree planting type | Landscape/pavers/grates |
| Tree spacing | |
| Small canopy | 15' on-center avg. |
| Medium canopy | 25' on-center avg. |
| Large canopy | 35' on-center avg. |
| Roadway & pedestrian lighting | Required: installed per TPW specifications |

| Curb-to-Curb | |
|---|-------------------------------------|
| F Gutter | 1'6" min |
| G Parking lane, brick paver (includes gutter) lane | 8' min (parallel alternating sides) |
| H Travel lane, brick paver | 9' min / 10' max |
| Bicycle facilities | Shared travel lane |

| Frontage | |
|--------------------------------------|--|
| I See applicable sub-district | |

SEC. 8.3.14. PATHWAY: TYPICAL

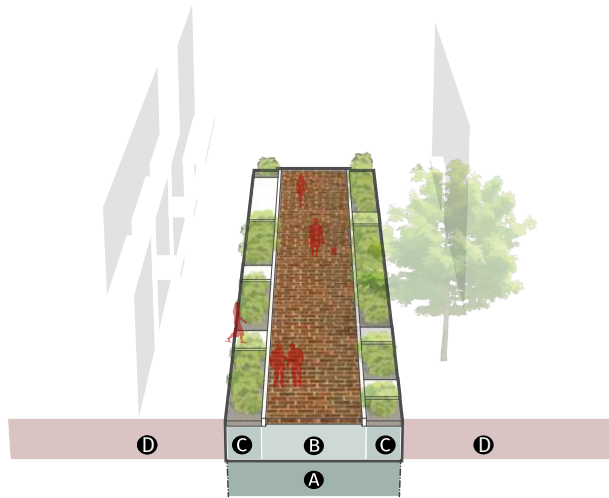

Public Realm

A Easement 20' min

Easement

B Paved pedestrian zone, brick pavers 10' min

C Remainder of easement 10' min total

Remainder of easement Landscape/pavers/grates

Pedestrian lighting Required: installed per TPW specifications

Frontage

D See applicable sub-district

SEC. 8.3.15. PATHWAY: WITH CATTLE RUN

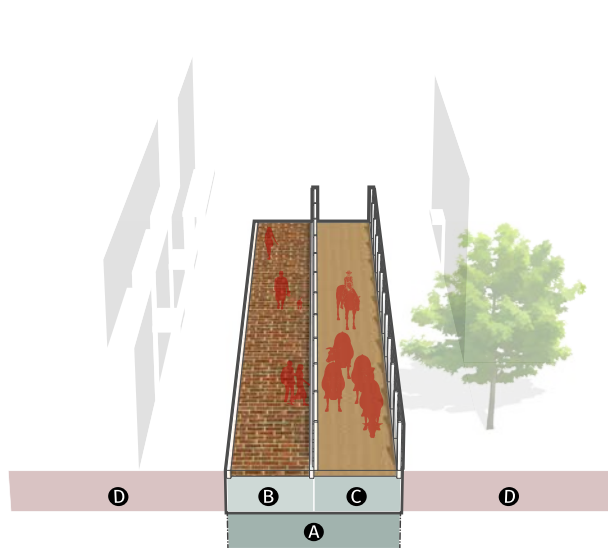

Public Realm

A Easement 20' min

Easement

B Paved pedestrian zone, brick pavers 10' min

C Livestock-run 10' min

Pedestrian lighting Required:
installed per TPW specifications

Frontage

D See applicable sub-district

SEC. 8.3.16. PATHWAY: RODEO PLAZA (NORTH)

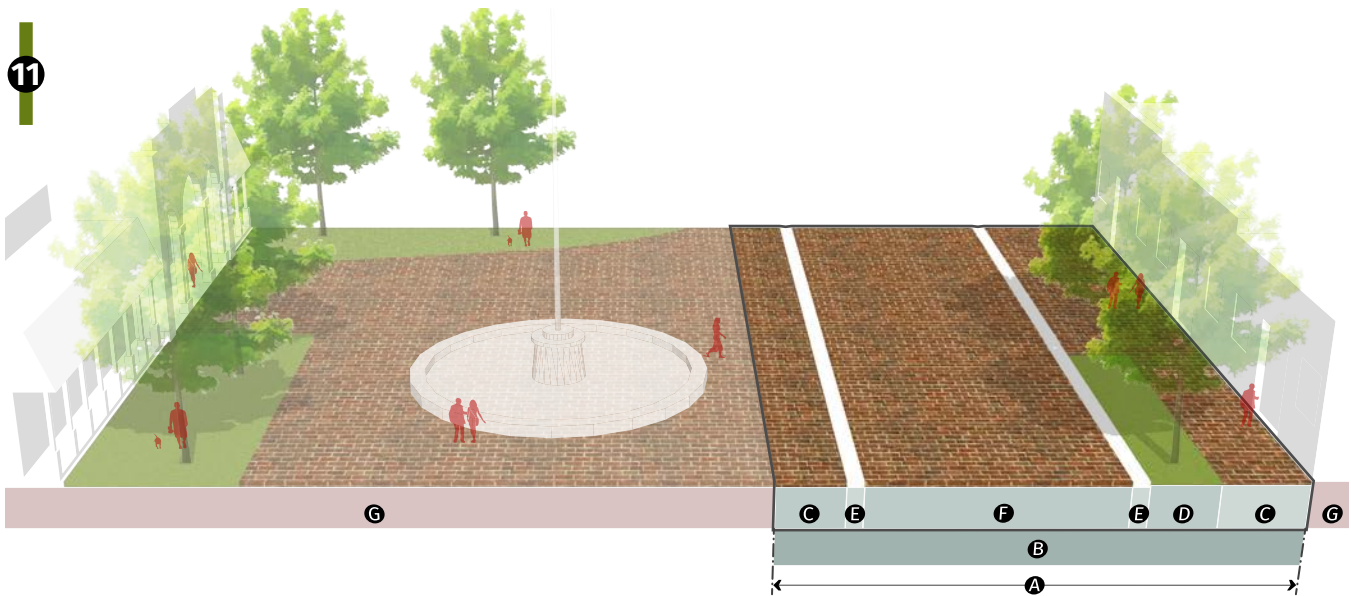

Public Realm

A Right-of-way 60' min

Right-of-Way

B Shared space, pavers 60' min

C Paved pedestrian zone 10' min

D Parkway depth 6' min

E Valley gutter 2' min

Street tree planting type Landscape/pavers/grates

Tree spacing: large canopy 35' on-center avg.

F Shared travel way 30' min

Roadway & pedestrian lighting Required: installed per TPW specifications

Frontage

G See applicable sub-district

SEC. 8.3.17. PATHWAY: RODEO PLAZA (SOUTH)

12

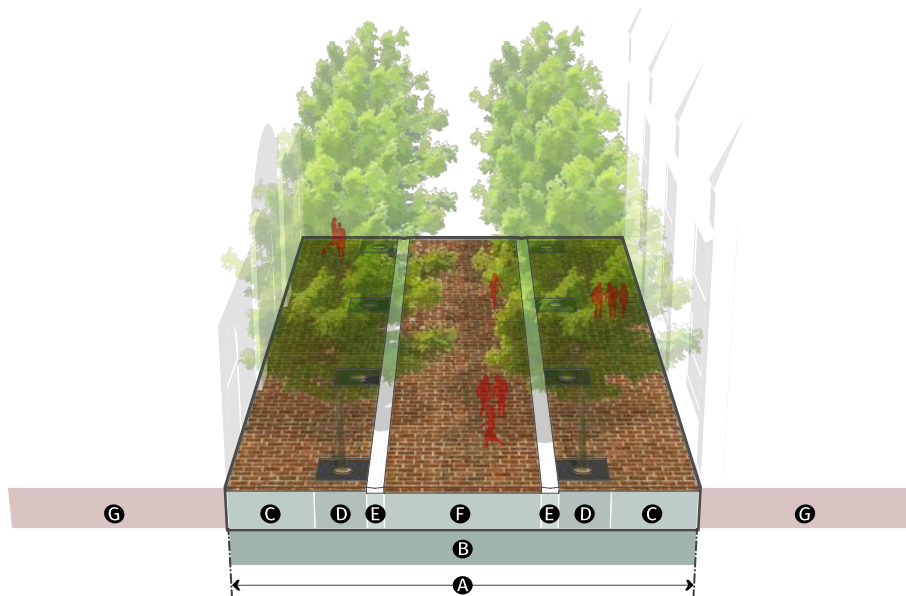

Public Realm

A Right-of-way 54' min

Right-of-Way

| | |
|--------------------------------|---|
| B Shared space, pavers | 54' min |
| C Paved pedestrian zone | 10' min |
| D Parkway depth | 6' min |
| Street tree planting type | Grates |
| Tree spacing: large canopy | 35' on-center avg. |
| E Valley gutter | 2' min |
| F Shared travel way | 18' min |
| Roadway & pedestrian lighting | If installed must be per TPW specifications |

Frontage

G See applicable sub-district

SEC. 8.3.18. PATHWAY: RODEO ALLEY

13

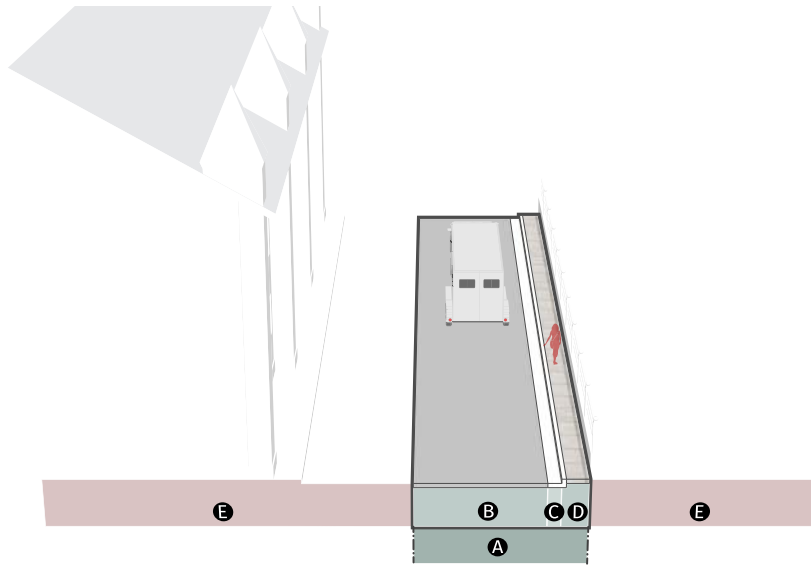

Public Realm

A Right-of-way 19' min

Right-of-Way

B Shared travel lane 15' min

C Gutter 1'6" min

D Paved pedestrian zone 2'6" min

Roadway & pedestrian lighting If installed must be per TPW specifications

Frontage

E See applicable sub-district

ARTICLE 9. ADMINISTRATION

| | |
|---|-----|
| Div. 9.1. Code Administration | 9-2 |
| Sec. 9.1.1. Authority | 9-2 |
| Sec. 9.1.2. Delegation of Authority | 9-2 |
| Div. 9.2. Historic Districts | 9-2 |
| Div. 9.3. Transition and Edge Districts | 9-2 |
| Sec. 9.3.1. Applicability | 9-2 |
| Sec. 9.3.2. Administrative vs. UDC Review | 9-2 |
| Sec. 9.3.3. Certificates of Appropriateness | 9-2 |
| Sec. 9.3.4. Review Process | 9-2 |
| Sec. 9.3.5. Code Modifications | 9-3 |

Div. 9.1. Code Administration

Sec. 9.1.1. Authority

The Administrator of the Stockyards Form District is the FBC Administrator. The FBC Administrator is responsible for the day-to-day administration of this Code.

Sec. 9.1.2. Delegation of Authority

The FBC Administrator may designate any staff member to represent the FBC Administrator in any function assigned by this Code. The FBC Administrator remains responsible for any final action.

Div. 9.2. Historic Districts

Applications for development approval in the Historic Districts will be reviewed in accordance with § 4.401, Historic Preservation Overlay District, of the Code of Ordinances.

Div. 9.3. Transition and Edge Districts

Sec. 9.3.1. Applicability

All private construction projects in the Transition and Edge Districts, with the exception of interior construction or exterior in-kind replacement work, are subject to review by the FBC Administrator or the Urban Design Commission. All buildings, streets, and public spaces by public entities are also subject to review.

Sec. 9.3.2. Administrative vs. UDC Review

Projects that conform to all standards of this Code may be approved administratively by the FBC Administrator without review by the Urban Design Commission. The Urban Design Commission will review applications that require major modifications.

Sec. 9.3.3. Certificates of Appropriateness

The FBC Administrator or Urban Design Commission will issue a Certificate of Appropriateness for approved projects.

Sec. 9.3.4. Review Process

A. Step 1: Project Consultation

1. Before submitting an application for review, an applicant must schedule a meeting with the FBC Administrator to discuss the review procedures and applicable standards for approval. This meeting is not intended as an approval meeting, but to provide the applicant with an overview of the application requirements and to identify issues or opportunities relating to compliance with the requirements of this Code.
2. The FBC Administrator will inform the applicant of requirements as they apply to the proposed project, provide a preliminary list of issues that will likely be of concern during formal application review, suggest possible modifications to the project, and identify any technical studies that may be necessary for the review process when a formal application is submitted.
3. The FBC Administrator will provide the applicant with a list of required application materials/information in order to submit a complete application for review.

B. Step 2: Application Submittal

Applications must be submitted to the FBC Administrator on forms and in such numbers as required by the Planning and Development Department.

1. All applications must be sufficient for processing before the FBC Administrator is required to review the application. The FBC Administrator will notify

the applicant whether or not the application is complete or whether additional information is required.

2. An application is sufficient for processing when it contains all of the information necessary to decide whether or not the development as proposed will comply with all of the requirements of this Code.

C. Step 3: Application Review

Upon determination of a complete application, the FBC Administrator will promptly distribute the application for review by City departments and external agencies.

1. The FBC Administrator will determine whether the application conforms to all applicable requirements of the Code.
2. Final action on an application will be based solely on findings as to compliance with all applicable provisions of this Code and other applicable technical requirements.
3. Where an application is denied, the reasons for denial must be stated in writing, specifying the provisions of the Code or other applicable technical requirements that are not in compliance. A revised application may be submitted for further consideration.
4. The FBC Administrator may send any administrative cases to the Urban Design Commission when they feel it needs additional oversight.

Sec. 9.3.5. Code Modifications

A. Purpose

1. Specific site features (steep slopes, flood plain, drainage, lot shape, physical barriers or easements) may create conditions that make compliance with a specific Code standard impractical or undesirable. It is also recognized that alternative

design solutions may achieve the principles stated above but may not comply with a specific standard.

2. This section establishes the procedures for considering requests for a modification to the standards. These are divided into minor modifications approved by the FBC Administrator (see [Sec. 9.3.5.C](#)) and major modifications approved by the Urban Design Commission (see [Sec. 9.3.5.D](#)).
3. It is the responsibility of the applicant to meet the burden of clearly demonstrating the reason for the requested code modification and to provide sufficient documentation to illustrate how the modification is related to a site constraint and/or how the modification would equal or exceed the existing standard in terms of achieving the following guiding principles.

B. Guiding Principles

The standards established in this Code are intended to achieve the following principles:

1. Implement [Sec. 1.1.4](#), Intent;
2. Maintain a safe, walkable and attractive urban environment along the street;
3. Encourage creativity, architectural diversity, and exceptional design;
4. Maximize opportunities for redevelopment and investment;
5. Require excellence in the design of the public realm (building on Fort Worth's history of civic art) and of buildings that front public spaces.
6. Promote the preservation and creation of distinctive neighborhoods that provide diverse urban housing options;
7. Promote development that will support transit and commercial services the community desires;

- 8. Protect integrity of established and significant historic/civic landmarks;
- 9. Increase the tree canopy;
- 10. Maximize connectivity and access; and
- 11. Support adopted plan policies and recommendations.

C. Minor Code Modifications

During the review process, the FBC Administrator is authorized to approve the following minor code modifications at the request of an applicant.

1. Building Setbacks

- a. Increase of up to 5 feet of a required maximum primary or side street setback.
- b. Decrease of up to 2 feet of a required minimum primary or side street setback.
- c. Decrease of up to 2 feet of a required common lot line or alley setback.

2. Build-to

Decrease of up to 10% of a primary or side street build-to requirement.

3. Parking Setbacks

- a. Decrease of up to 5 feet of a required primary or side street parking setback.
- b. Decrease of up to 2 feet of a required common lot line or alley setback.

4. Building Height

Increase of up to 2 feet of the maximum building height.

5. Building Mass

Increase of up to 10 feet of the maximum length of a street-facing building facade.

6. Transparency

- a. Decrease of up to 5% of the minimum percentage of windows and doors that must cover a street-facing building facade.
- b. Increase of up to 5 feet of a maximum allowed blank wall area on a street-facing building facade.

7. Story Height

- a. Decrease of up to 1 foot of a required minimum ground floor elevation or up to 18 inches for accessibility needs.
- b. Increase of up to 2 feet of a required maximum ground floor elevation.
- c. Increase of up to 5 feet of a required maximum ground floor elevation if there is a slope of 10% or greater (as measured parallel to the street).
- d. Decrease of up to 1 foot of a required minimum ground story floor height.

8. Pedestrian Access

Increase of up to 10 feet of the maximum required distance between street-facing entrances.

9. Landscaping

Where conflicts arise, perimeter plantings or other required landscaping abutting a street edge may be substituted for streetscape planting within the public right-of-way.

10. Streetscape

Staff may administratively approve any modifications to streetscape requirements caused by utility conflicts, fire hydrants, shallow underground utilities, curb cuts or any other obvious impediment.

11. Signs

Increase of up to 20% of the maximum size of a permitted sign type.

D. Major Modifications

1. The Urban Design Commission is responsible for reviewing major modification requests that do not qualify as minor modifications, and to review appeals of staff decisions/interpretations.
2. When reviewing requests for major modifications, the Urban Design Commission must consider the guiding principles stated in Sec. 9.3.5.B.
3. When reviewing requests for major modifications, the Urban Design Commission must consider the design guidelines for the applicable district (Div. 3.4 for a Transition District or Div. 4.4 for an Edge District).
4. The Urban Design Commission's decision to approve or deny a request for a major modification is based on the following considerations:
 - a. The physical conditions of the property, such as steep slopes, flood plain, drainage, lot shape, physical barriers or easements, make compliance to the specific standard physically impossible, and this hardship is not created by the applicant; or
 - b. The applicant meets the burden of presenting an alternative means of compliance that clearly demonstrates how the code exception would equal or exceed the existing standard in terms of achieving the guiding principles stated in Sec. 9.3.5.B; and

- c. Conformance with the applicable design guidelines (Div. 3.4 for a Transition District or Div. 4.4 for an Edge District); and
- d. The modification will not significantly impact adjacent property owners, the character of the area, traffic conditions, parking, public infrastructure, storm water management, and other matters affecting the public health, safety and general welfare; and
- e. The modification will not result in a substantial departure from the basic urban principle that new development should add value to the animation and pedestrian walkability of the street edge.

Sec. 9.3.6. Urban Design Commission Recommendation to City Council

The UDC recommends that in support of ongoing heritage tourism at the Fort Worth Stockyards, the City of Fort Worth should work cooperatively with the Economic Development Department and Events Facilities Department to pursue potential opportunities for permanent parking for vehicles of audiences attending events at the Colesium, and for transport of livestock, including trucks and trailers, to be located along the storm water easement area, as related to specific requirements for utility easements and existing infrastructure located there.

Also, the UDC recommends that City should explore all potential options to preserve and enhance opportunities for museums and other cultural facilities to maintain their presence at desirable locations within the Stockyards, through coordination with the Economic Development Department and other relevant institutions, and to identify potential incentives and programs that can promote their ongoing economic viability, so that they can continue to operate in a manner that enhances heritage tourism within the Fort Worth Stockyards.

ARTICLE 10. DEFINITIONS

| | |
|---|------|
| Div. 10.1. General Provisions | 10-2 |
| Sec. 10.1.1. General Meaning of Words & Terms | 10-2 |
| Sec. 10.1.2. Abbreviations | 10-2 |
| Div. 10.2. Defined Terms..... | 10-2 |

Div. 10.1. General Provisions

Sec. 10.1.1. General Meaning of Words & Terms

- A. All words and terms used have their commonly accepted and ordinary meaning unless they are specifically defined in this Code or the context in which they are used clearly indicates to the contrary.
- B. When vagueness or ambiguity is found to exist as to the meaning of any word or term used, any appropriate canon, maxim, principle or other technical rule of interpretations or construction used by the courts of this state may be employed to resolve vagueness and ambiguity in language.

Sec. 10.1.2. Abbreviations

n/a: Not applicable

ROW: Right-of-Way

SF: Square Feet

Div. 10.2. Defined Terms

The following terms are defined for the purpose of this Code. Terms not defined below may be defined in Chapter 9 of the City of Fort Worth Zoning Ordinance. In such case, the definition contained in Chapter 9 should be used. If there is a conflict between a definition in Chapter 9 and this Code, the definition in this Code must be used.

Awning (see [Sec. 5.1.4.B](#)).

Balcony (see [Sec. 5.1.4.C](#)).

Building Facade means the face of a building that delineates the edge of conditioned floor space.

Canopy (see [Sec. 5.1.4.B](#)).

FBC Administrator means the person responsible for the day-to-day administration of this Code, or their designee.

Forecourt (see [Sec. 5.1.4.D](#)).

Gallery (see [Sec. 5.1.4.E](#)).

Porch (see [Sec. 5.1.4.F](#)).

Stoop (see [Sec. 5.1.4.G](#)).