

Community Information Meeting for *Paschal Neighborhood Infill Street Lighting Project*

Good evening all! The meeting will start at 6:05PM to give residents enough time to log in. Please mute yourselves to avoid echo/ disturbance during the meeting. Please ask your questions using the chat box as shown in picture below. Finally, please be aware this meeting is being recorded so those who are not able to attend can watch it later.

Note: To mute please press the speaker symbol on the screen



Community Information Meeting for
*Paschal Neighborhood
Infill Street Lighting Project*

City Project No. 103408

Council District 9

Project Manager: Chad Allen, PE, CFM

Project Engineer: Dunaway



April 14, 2022

Presentation Topics

- Introduction of Project Team
- Project Funding
- Project Scope and Goals
- Project Limits
- Lighting Analysis – Existing and Proposed Conditions
- Proposed Improvements – Street by Street
- Project Status and Schedule
- Contact Information
- Questions?

Project Funding

- Approved in 2018 Bond Program

Street Lights:

\$10,000,000

Project Description: Citywide installation and/or replacement of roadway lighting in neighborhoods and along major roadways. Program will focus on infill lighting, filling gaps and making upgrades that provide uniformity and meet district goals.

Project Scope and Goals

- Add new lighting in the Paschal Neighborhood area.
- Fill in gaps and implement street lighting spacing in accordance with the current City Standards as described in our Transportation Engineering Manual.
 - Ideal spacing is 200 feet
 - Maximum spacing is 300 feet
- Update existing lighting to new LED lighting throughout the neighborhood.
- Use overhead wires and wooden poles.

Project Scope and Goals (cont.)

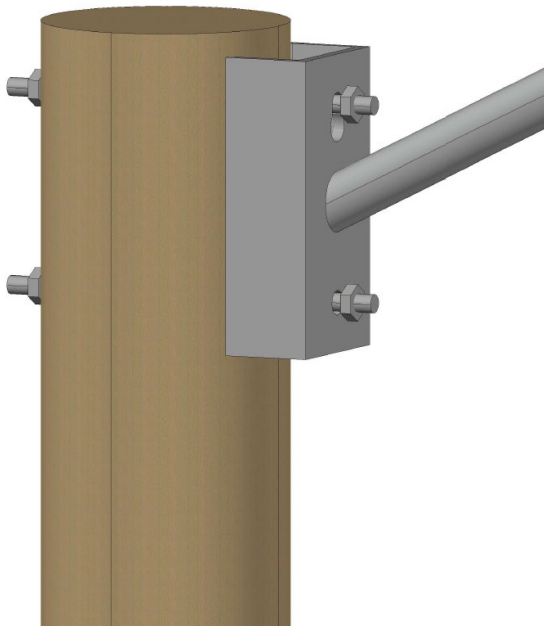

TYPICAL STREET LIGHT
ARM MOUNTING ON
WOODEN POLE



TYPICAL STREET LIGHT
NEW LED FIXTURE



TYPICAL STREET LIGHT
MOUNTED ASSEMBLY

Project Limits

Paschal Neighborhood area between:

- Park Hill Way and W. Berry Street (north/south limits)
- and
- Forest Park Blvd. and 8th Avenue (west/east limits)
- Includes approx. 3.3 miles of roadway



Lighting Analysis: Existing Conditions

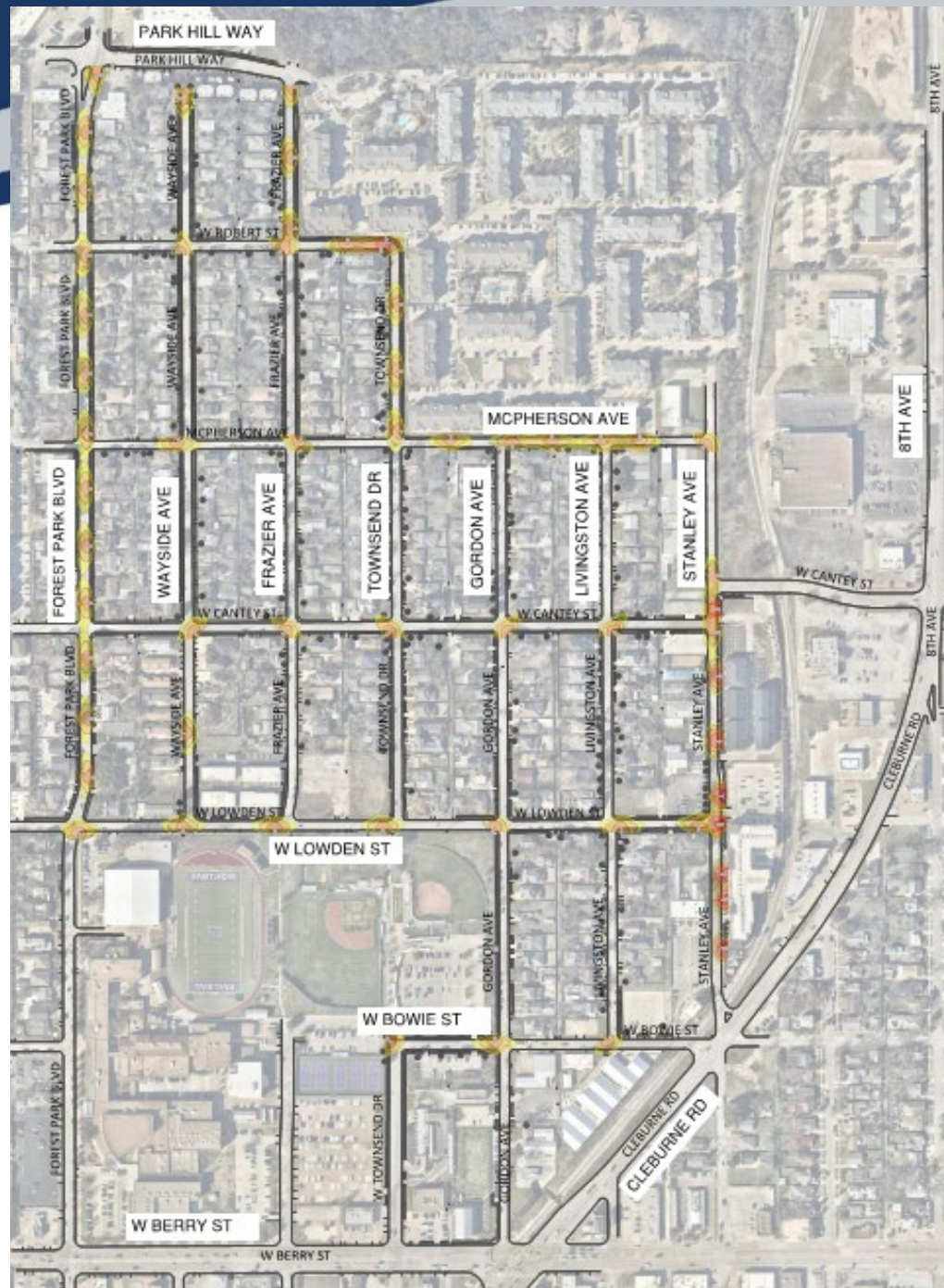

Lighting Analysis: Proposed Conditions

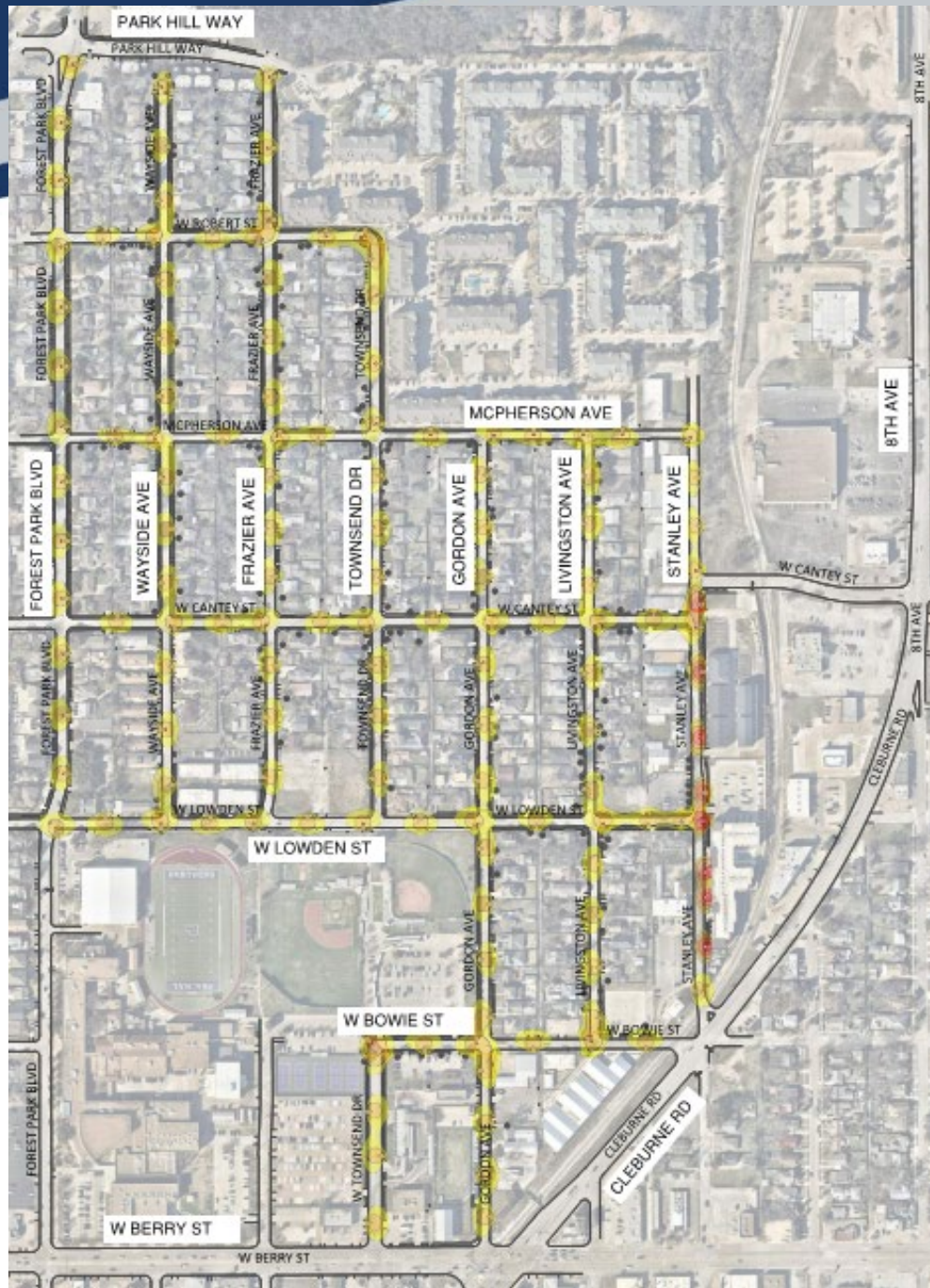

Proposed Improvements

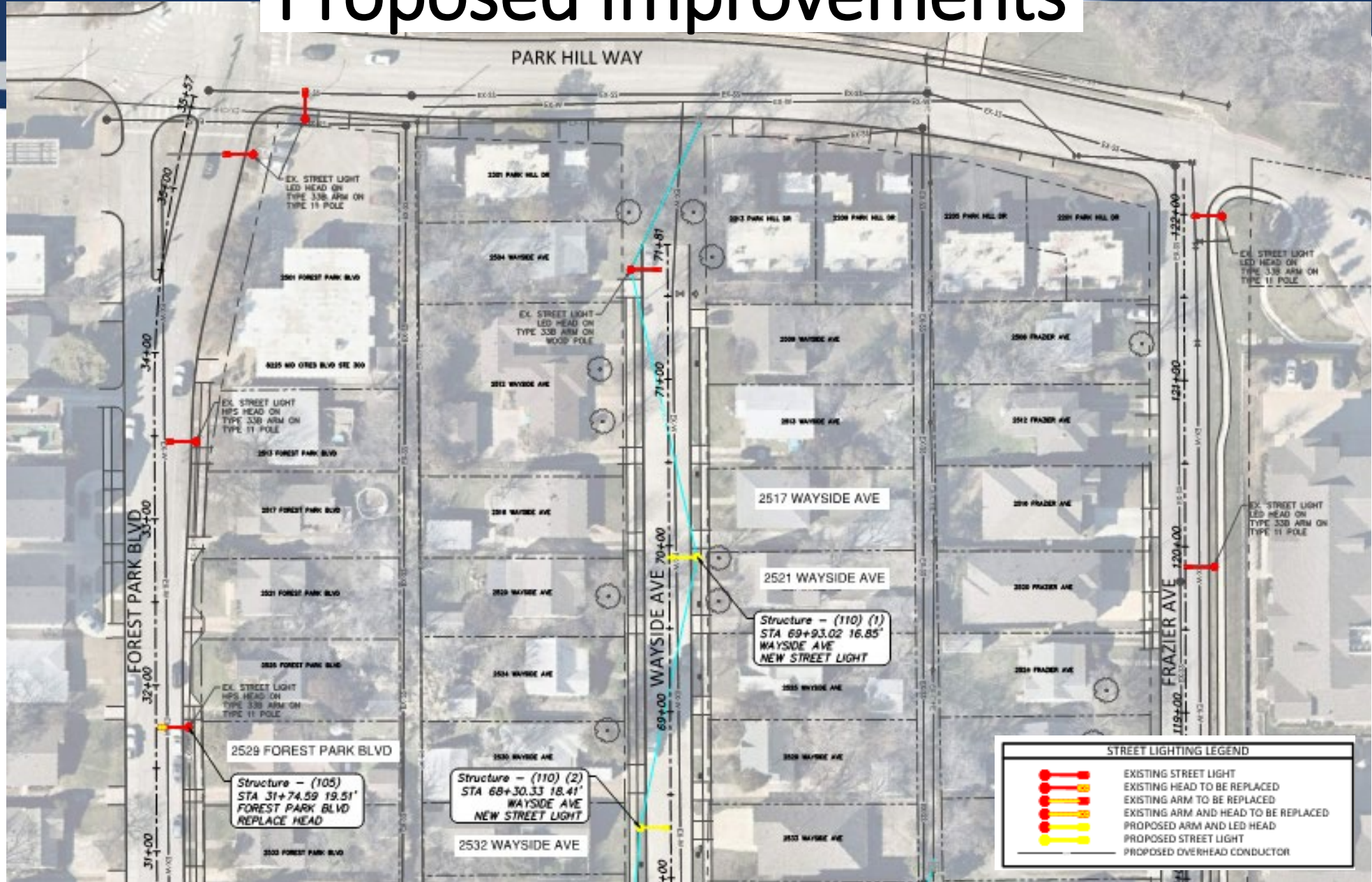
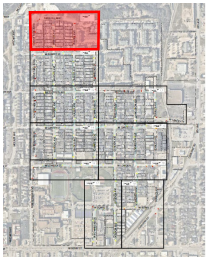

Proposed Improvements

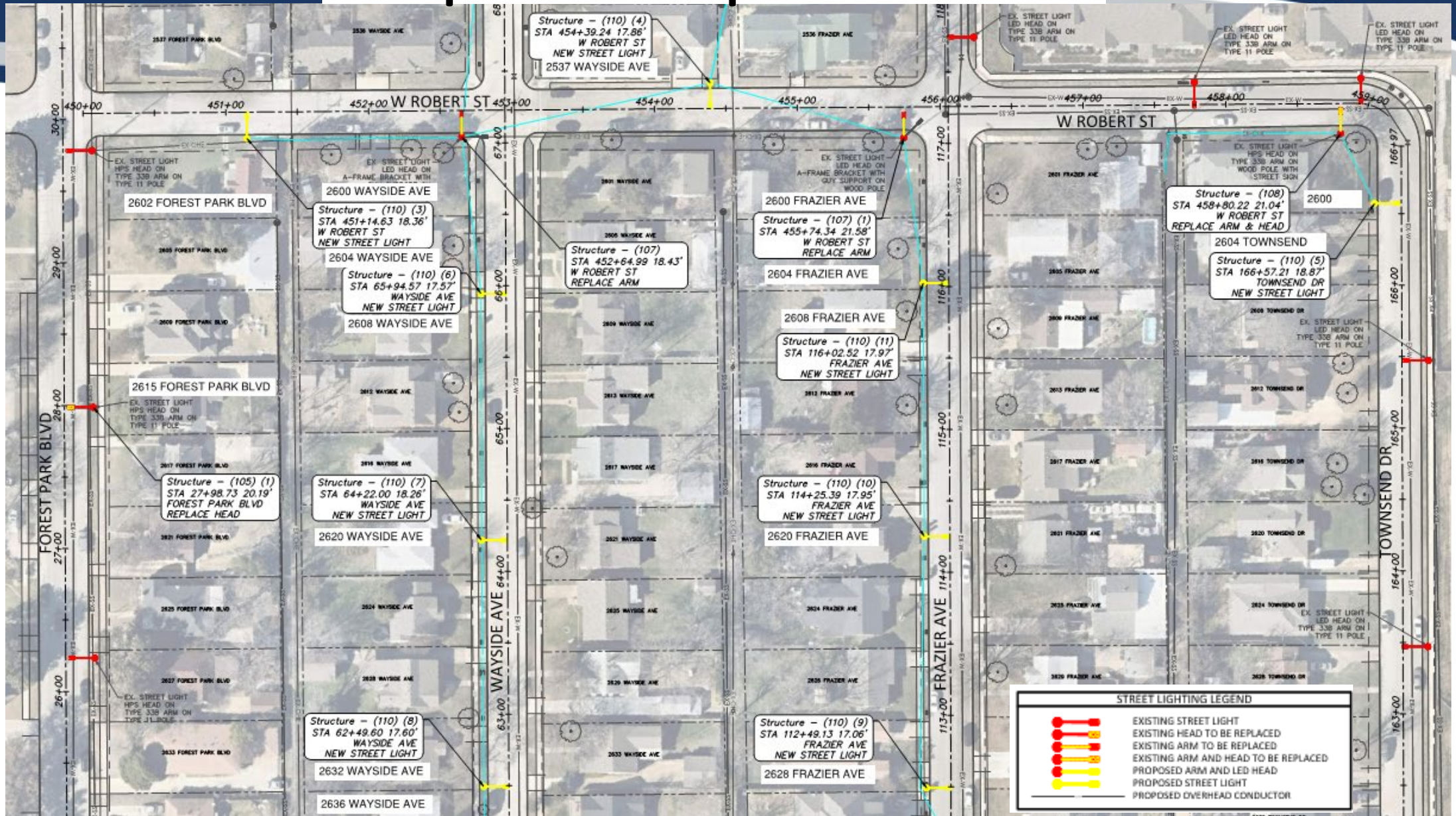
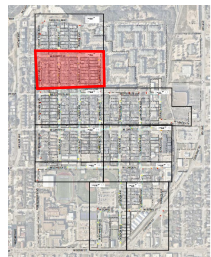

Proposed Improvements

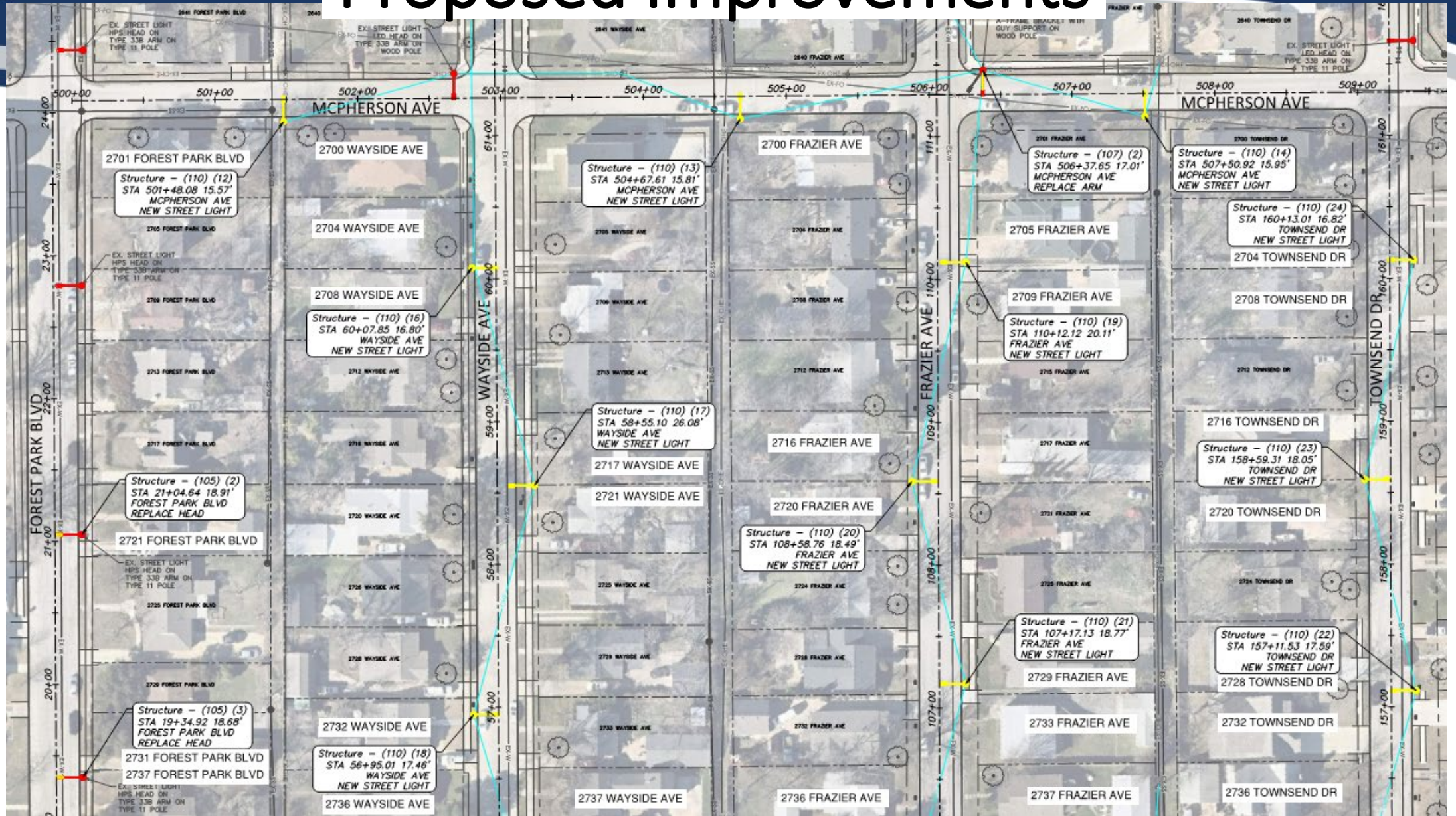
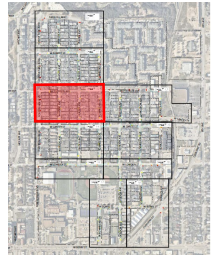

Proposed Improvements

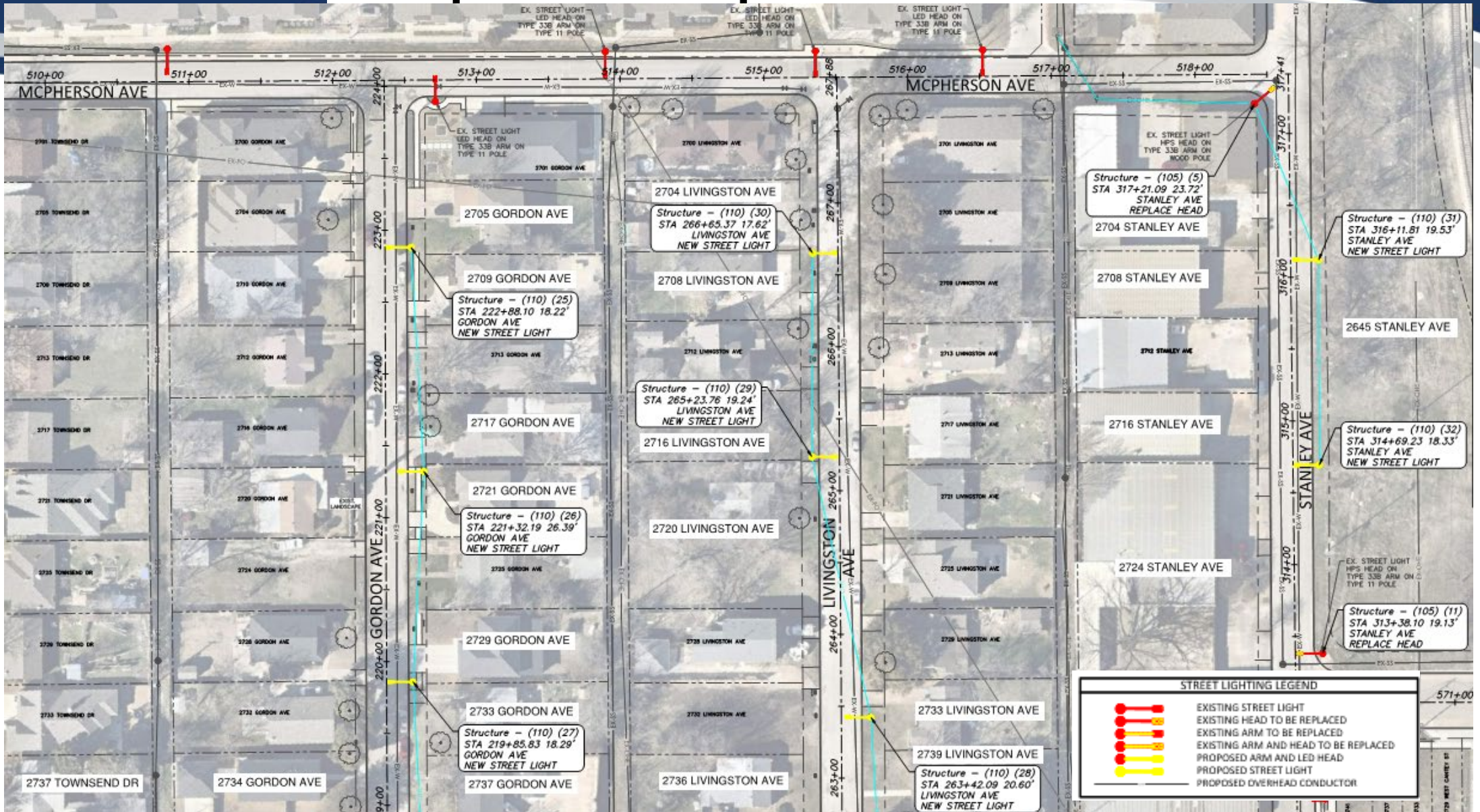
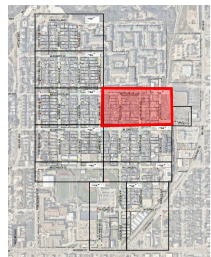

Proposed Improvements

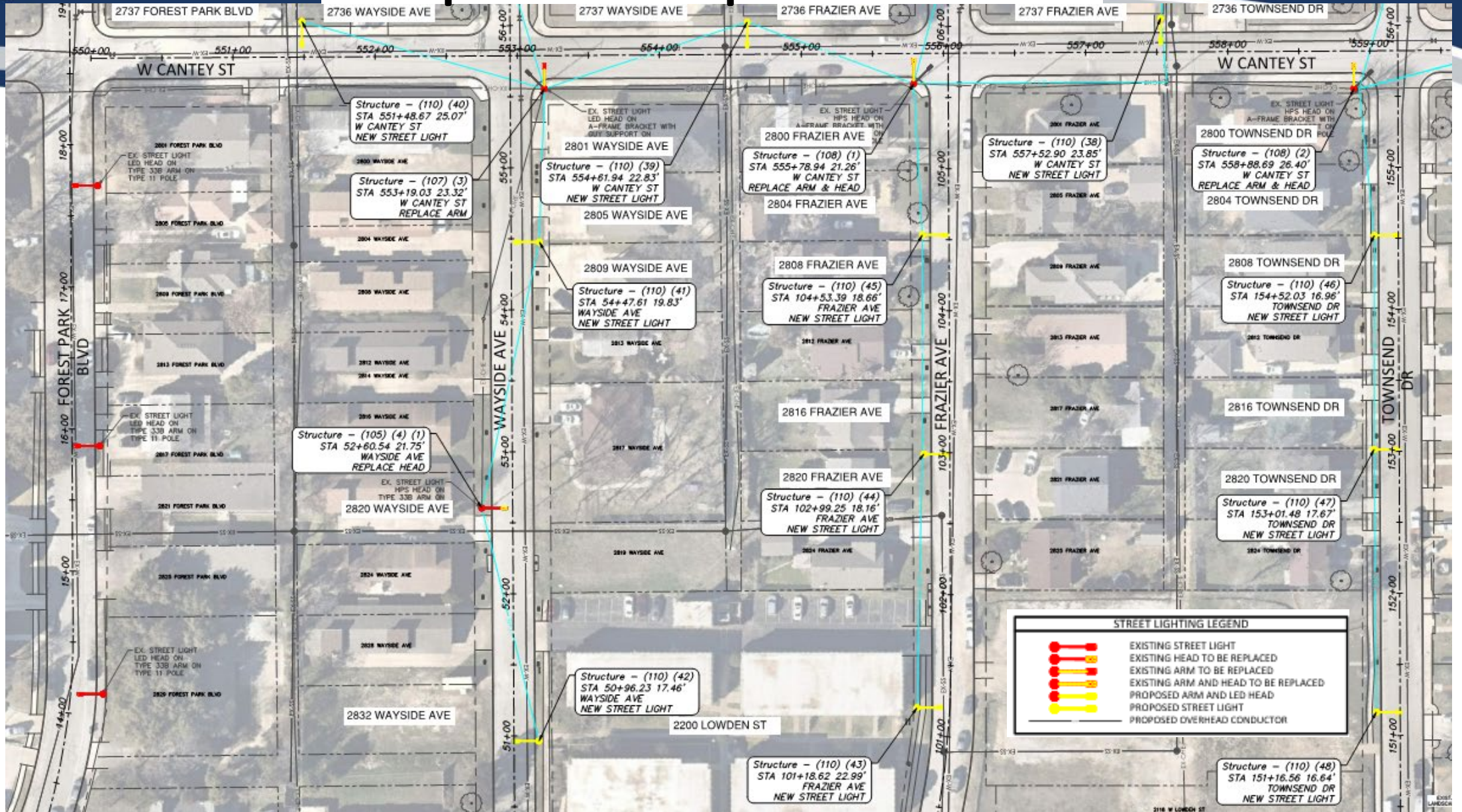
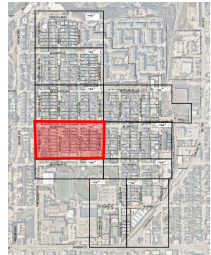

Proposed Improvements

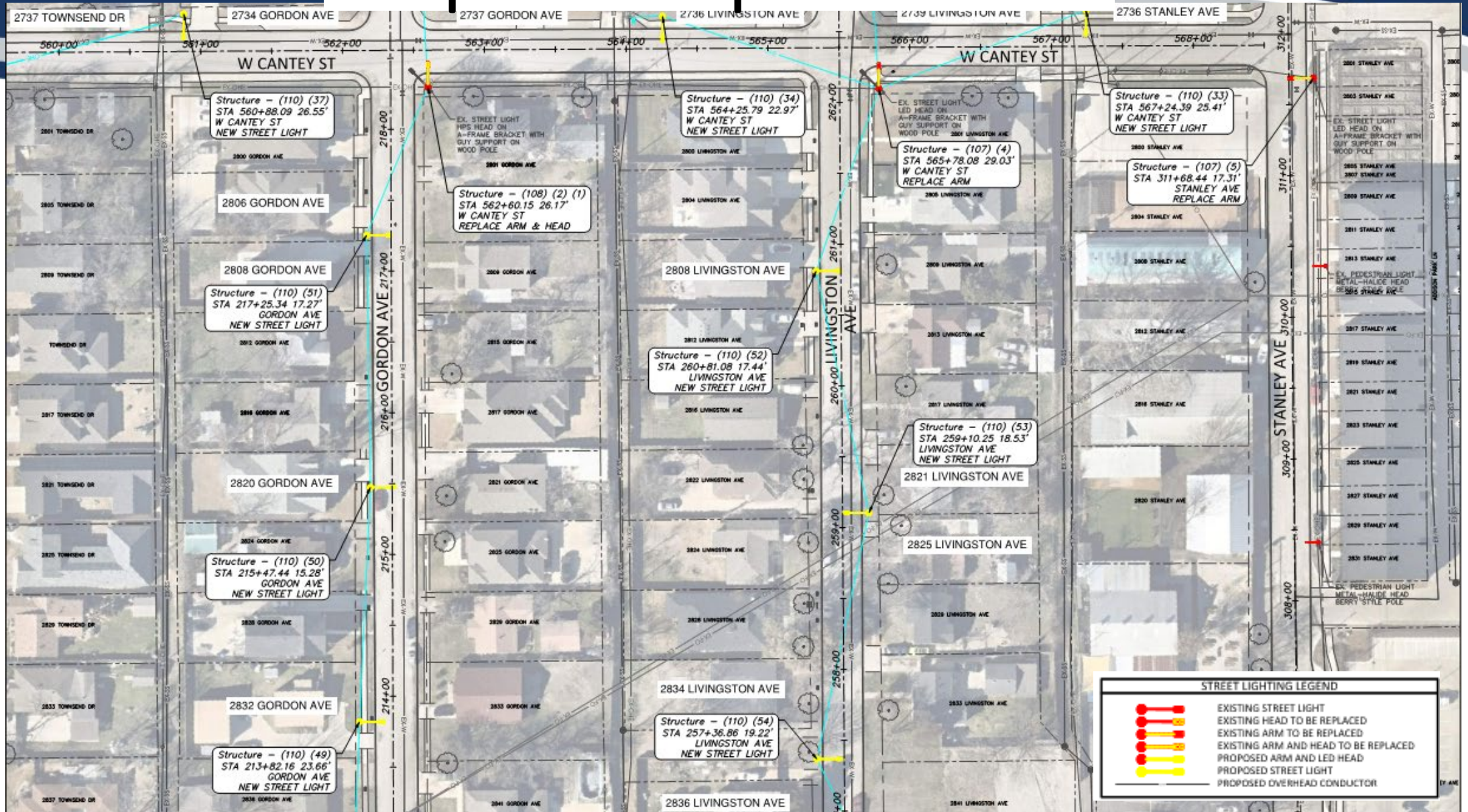
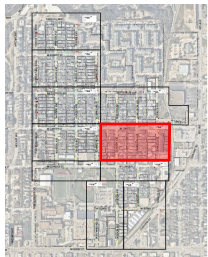



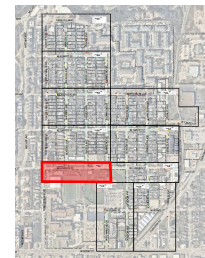
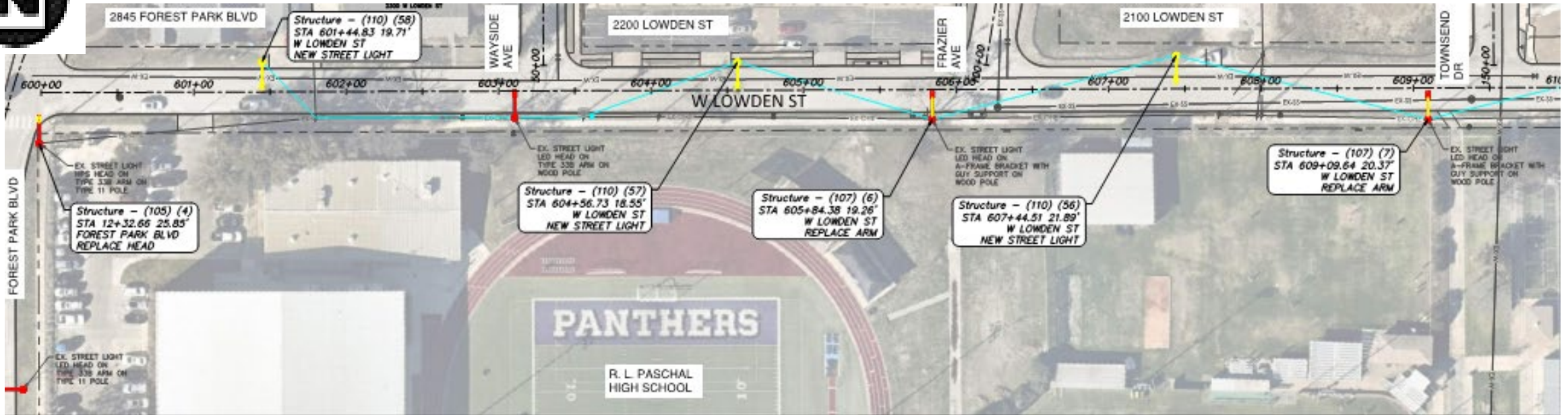



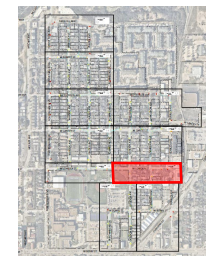
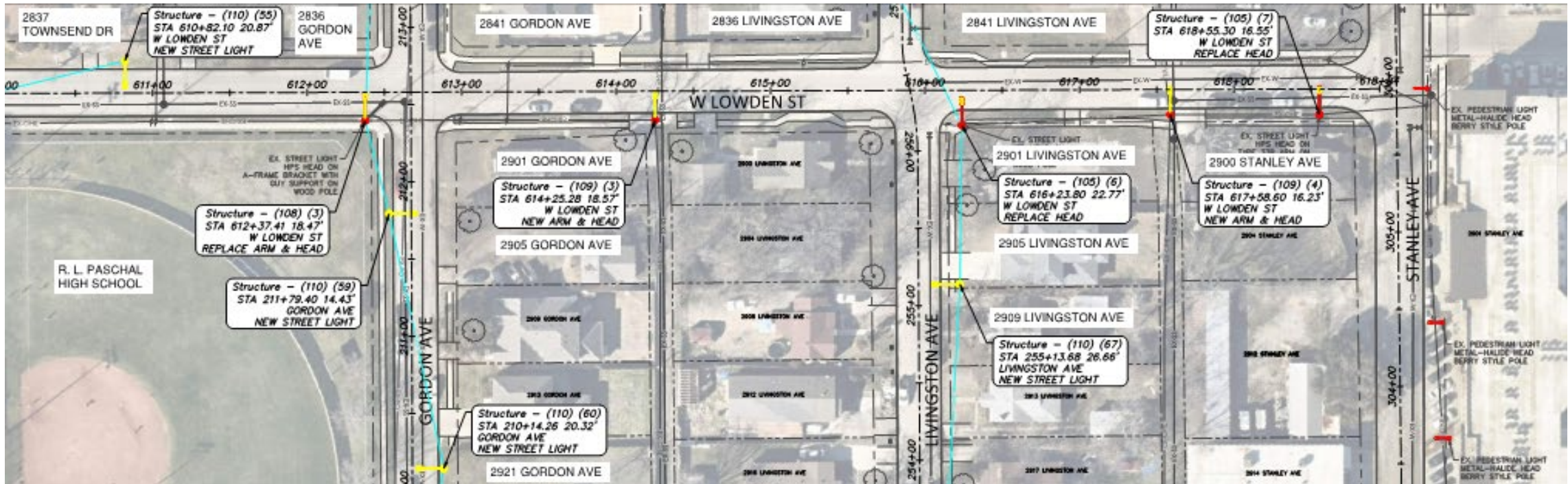

Proposed Improvements



STREET LIGHTING LEGEND	
	EXISTING STREET LIGHT
	EXISTING HEAD TO BE REPLACED
	EXISTING ARM TO BE REPLACED
	EXISTING ARM AND HEAD TO BE REPLACED
	PROPOSED ARM AND LED HEAD
	PROPOSED STREET LIGHT
	PROPOSED OVERHEAD CONDUCTOR

Proposed Improvements



STREET LIGHTING LEGEND	
	EXISTING STREET LIGHT
	EXISTING HEAD TO BE REPLACED
	EXISTING ARM TO BE REPLACED
	EXISTING ARM AND HEAD TO BE REPLACED
	PROPOSED ARM AND LED HEAD
	PROPOSED STREET LIGHT
	PROPOSED OVERHEAD CONDUCTOR

Proposed Improvements

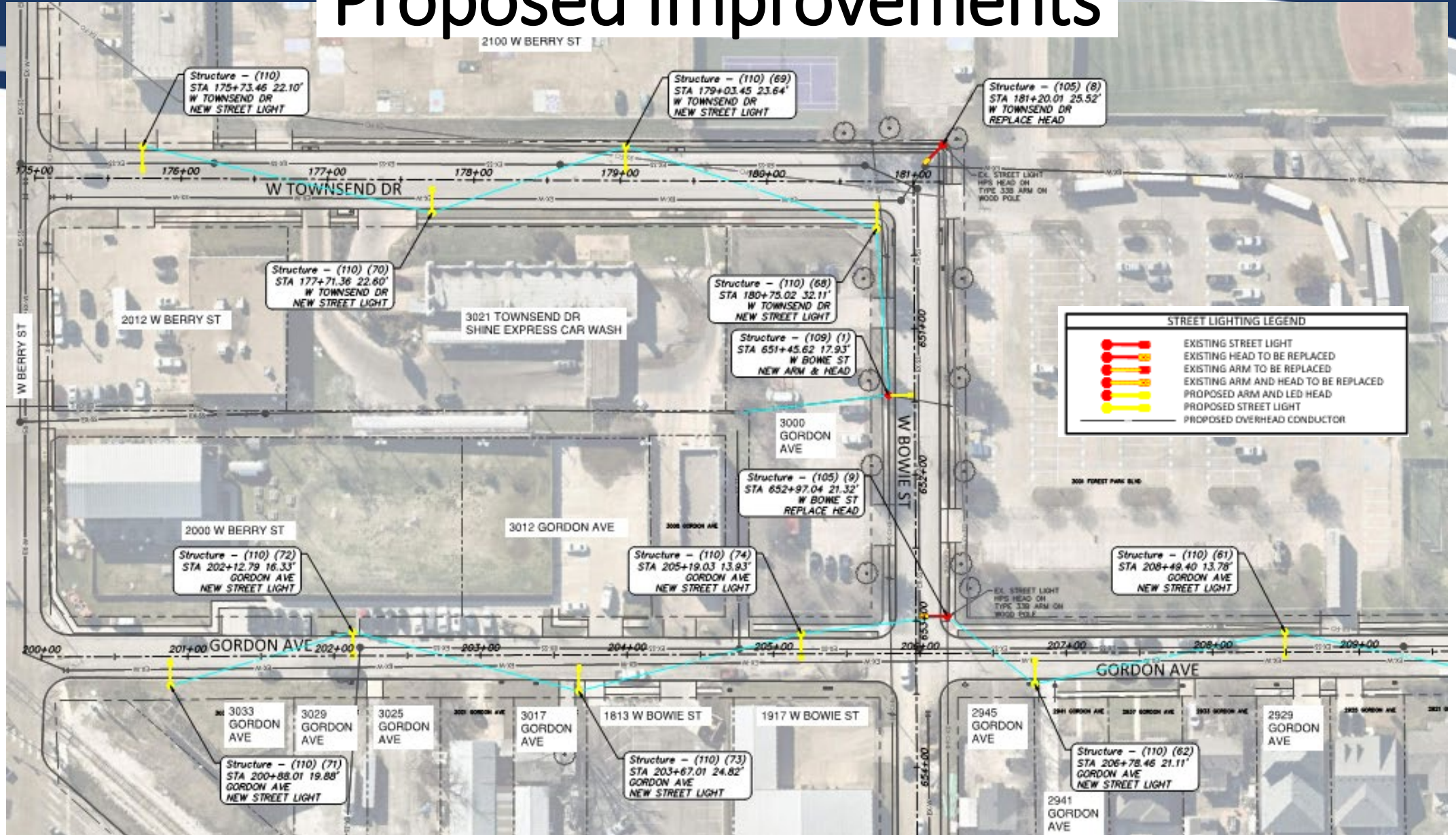
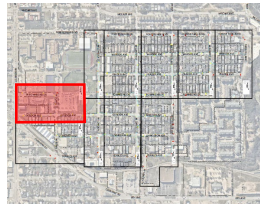

Proposed Improvements

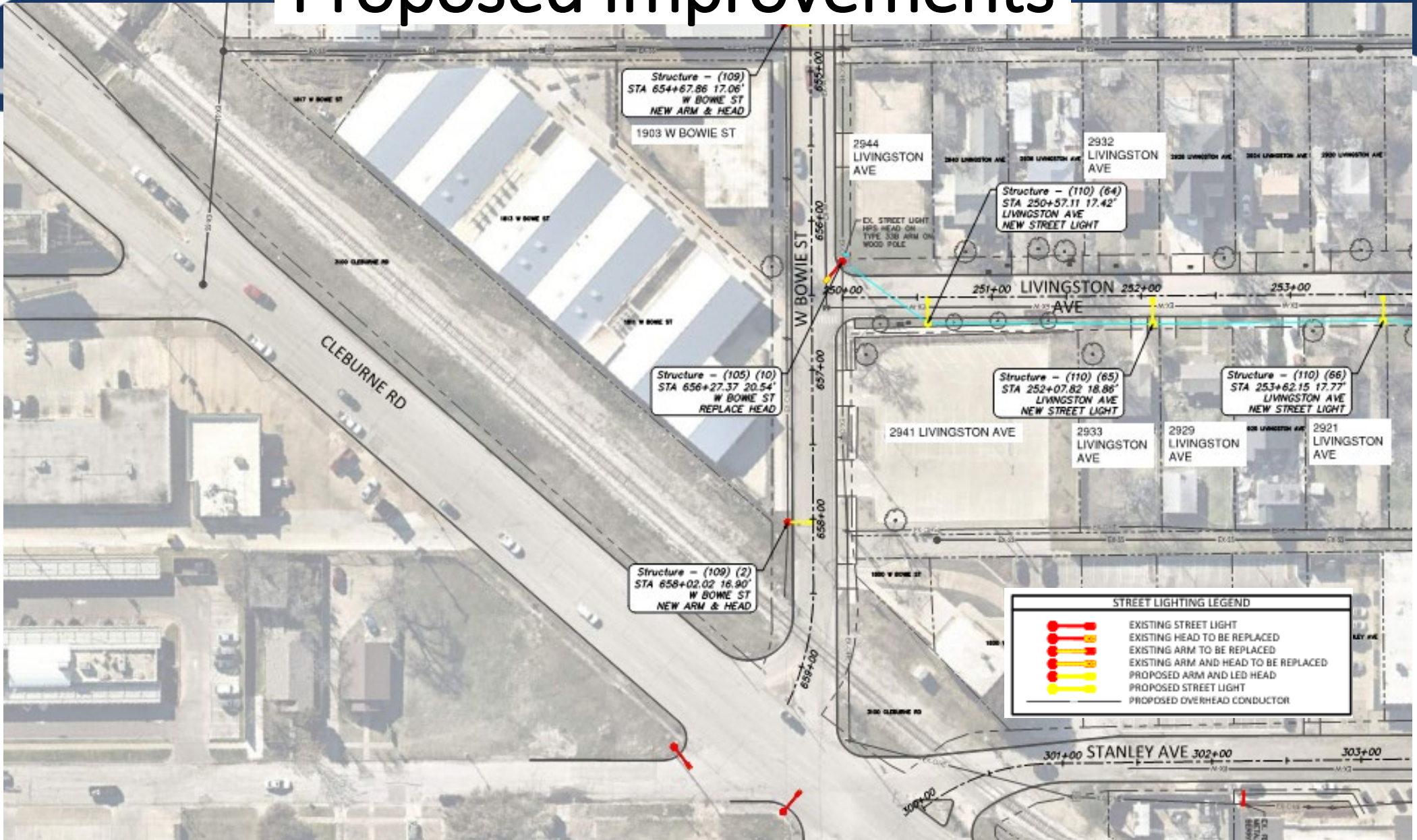
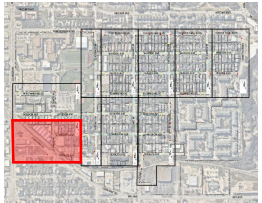

Project Status and Schedule

- Current Status: 60% Design Complete
- Next Steps
 - Conduct Constructability Field Review – April 2022
 - Conduct Peer Review Meeting – April 2022
- Complete Design: Summer 2022
- Start Construction: Winter 2022/2023
- End Construction: Summer 2023

QUESTIONS?

Contact Information

Chad Allen, P.E., CFM

Project Manager

817-392-8021

chad.allen@fortworthtexas.gov